

# 101<sup>st</sup> Congress

25<sup>TH</sup> NOVEMBER 2023  
SHARM-EL-SHEIKH, EGYPT



## CONTENTS

<b>Contents</b>	<b>2</b>
<b>Attendance</b>	<b>3</b>
<b>Present or Represented Federations</b>	<b>4</b>
<b>Agenda</b>	<b>9</b>
<b>Validation of attendance and proxies</b>	<b>10</b>
<b>Addresses</b>	<b>13</b>
<b>Ratification of the New Federations</b>	<b>16</b>
<b>Approval of the Report of the 2022 Congress held in Lausanne (SUI)</b>	<b>18</b>
<b>Approval of the Report of the 2023 Extraordinary Congress held online</b>	<b>20</b>
<b>Approval of the 2022 Annual Report of the Executive Committee</b>	<b>21</b>
<b>Financial report 2022, auditors' report, approval of the accounts, discharge to the Executive Committee and the auditors</b>	<b>22</b>
<b>Budget 2024</b>	<b>23</b>
<b>Appointment of the auditors for 2024</b>	<b>24</b>
<b>Vote to award the organisation of the World Championships</b>	<b>25</b>
2025 Juniors/Cadets: candidatures of CHN/EST	
2025 Seniors: candidature of GEO	
2026 Juniors/Cadets: candidatures of BRA/UZB	
2026 Seniors: candidature of HKG	
<b>Call for candidatures for the organisation of the World Championships</b>	<b>33</b>
2027 Juniors/Cadets	
2027 Seniors	
2025, 2026 and 2027 Veterans	
<b>Proposals submitted to the Congress, reports from the Commissions, Councils and Ethics Committee. Urgent decisions regarding the Rules</b>	<b>35</b>
<b>Progress reports from the working groups</b>	<b>50</b>
<b>Proposals from the Ukrainian Fencing Federation</b>	<b>51</b>
<b>2023 Chevalier Feyerick Challenge</b>	<b>62</b>
<b>2023 Fair-Play Trophy</b>	<b>63</b>
<b>Winners of the 2023 FIE official rankings and the Nations' Grand Prix</b>	<b>64</b>
<b>Any other business. Final Remarks</b>	<b>67</b>
<b>Annexes</b>	<b>68</b>

## Attendance

The meeting opened at 9:30 am.

### Took place at the tribune:

Mr. Emmanuel KATSIADAKIS (MH, GRE)  
Ms. Ferial Nadira SALHI (ALG)  
Ms. Erika AZE (LAT)  
Ms. Ana Irene DELGADO GUERRA (PAN)  
Mr. Abdelmoneim ELHUSSEINY (EGY)  
Ms. Nathalie RODRIGUEZ M.-H.  
Mr. Dieter LAMMER

Interim President  
Secretary-Treasurer  
Vice-President  
Vice-President  
Vice-President  
CEO  
Technical and Sport Director

### Members of the Executive Committee:

Ms. Velichka HRISTEVA (BUL)  
Mr. Novak PEROVIC (RSA)  
Mr. Oleg PESKOV (KAZ)  
Mr. Haibin WANG (CHN)  
Mr. Donald ANTHONY JR (USA)  
Mr. Paolo AZZI (ITA)  
Mr. Yuki OTA (JPN)

### Presidents of the Confederations:

Mr. Mbagnick NDIAYE (SEN)  
HH. Engr. Sheikh Salem Sultan S. AL QASIMI (UAE)  
Mr. Giorgio SCARSO (ITA)  
Mr. Vitaly LOGVIN (MEX)  
Mr. Ruben LIMARDO (VEN)

President of the African Confederation  
President of the Asian Confederation  
President of the European Confederation  
President of the Pan-American Confederation  
President of the Athletes Commission

### Absent with apologies:

Ms. Rusni ABU HASSAN (MAS)  
Mr. Bruno GARES (FRA)  
Mr. Vadym GUTSAIT (UKR)  
Ms. Helen SMITH (MH, AUS)

President of the Oceanian Confederation

### Members of Honour:

Mr. Jacek BIERKOWSKI (POL)  
Mr. Victor GROUPIERRE (ARG)  
Mr. Bert M. J. VAN DE FLIER (NED)  
Mr. Peter JACOBS (GBR)

## Present or Represented Federations

<b>AFGHANISTAN</b>	Represented by Kazakhstan
<b>ALGERIA</b>	Omar BENADOUDA
<b>AMERICAN SAMOA</b>	Represented by Guam
<b>ANGOLA</b>	Meven PEREIRA
<b>ANTIGUA AND BARBUDA</b>	Rameez MASCALL
<b>ARGENTINA</b>	Victor Sergio GROUPIERRE (MH)
<b>ARMENIA</b>	Armen GRIGORYAN Samvel ABRAHAMYAN
<b>ARUBA</b>	Oswald LEONARD Migalda Marieta JANSEN DE CUBA
<b>AUSTRALIA</b>	Davide WHEELER
<b>AUSTRIA</b>	Ursula HINTERSEER
<b>AZERBAIJAN</b>	Vasif MAMMADOV
<b>BAHAMAS</b>	Anthony Delwhite LEWIS
<b>BAHRAIN</b>	Arhan SALEH FARAJ
<b>BARBADOS</b>	Ralph YORK
<b>BELARUS</b>	Represented by Russia
<b>BELGIUM</b>	Jeffrey DELATTRE
<b>BELIZE</b>	Represented by Uruguay
<b>BENIN</b>	Represented by Ivory Coast
<b>BOLIVIA</b>	Represented by Brazil
<b>BOTSWANA</b>	Mandlenkosi MASUKU
<b>BRAZIL</b>	Ricardo Pacheco MACHADO Arno Perillier SCHNEIDER
<b>BRUNEI DARUSSALAM</b>	Nashriq MOKSIN
<b>BULGARIA</b>	Velichka HRISTEVA
<b>BURKINA FASO</b>	Djibril ZEBA
<b>CAMBODIA</b>	Ang SOK
<b>CAMEROON</b>	Marcel AMOUGOU Nadine YOUNGAP
<b>CANADA</b>	Yann BERNARD Lisa HUZEL
<b>CAPE VERDE</b>	Maria RAMOS SILVA
<b>CHILE</b>	Barbara BLUMEL
<b>CHINA</b>	Haibin WANG
<b>COLOMBIA</b>	Represented by Argentina
<b>CONGO</b>	Represented by Cameroon
<b>COSTA RICA</b>	Luis Alberto CRUZ MELENDEZ
<b>CROATIA</b>	Antonio TRCIN Irena SULJIC
<b>CUBA</b>	Alhajadis Ricardo BANDERA MIRANDA



<b>CZECHIA</b>	Vilem MADR
<b>CYPRUS</b>	Represented by Serbia
<b>DENMARK</b>	Jan SYLVEST JENSEN Louise SEIBAEK
<b>DOMINICA</b>	Represented by Peru
<b>ECUADOR</b>	Carlos ECHEVERRIA CORDOBA
<b>EGYPT</b>	Mohamed Tarek ELHUSSEINY Ahmed KHDER Samer HASHEM Ahmed ALMAIDANY Mohamed ABOLILA Khaled KABESH
<b>EL SALVADOR</b>	Juan Jose Roberto GÓMEZ Melissa Elizabeth ALVARENGA RAMIREZ
<b>ESTONIA</b>	Peeter JÄRVELAID Heino MÄRKIS
<b>FRANCE</b>	Sylvie LE MAUX Benoît PINCEMAILLE Pierre GUICHOT Julien RICHEL COOPER
<b>GEORGIA</b>	Merabi BAZADZE Nino JERENASHVILI
<b>GHANA</b>	Represented by Botswana
<b>GERMANY</b>	Claudia BOKEL Reka SZABO Alexander BÖHM
<b>GREECE</b>	Represented by Romania
<b>GREAT BRITAIN</b>	Hilary PHILBIN Janet HUGGINS Georgina USHER Patricia AIYENURO Peter JACOBS (MH)
<b>GUAM</b>	Anthony CAMACHO
<b>GUATEMALA</b>	Otto Rene VALLADARES BALDERRAMOS
<b>GUINEA</b>	Ben Daouda NASS
<b>GUYANA</b>	Kalam JUMAN-YASSIN Bernadette JUMAN-YASSIN
<b>HAITI</b>	Dukerns Louis JOSEPH
<b>HONDURAS</b>	Represented by Venezuela
<b>HONG KONG, CHINA</b>	Wing Sun YEUNG
<b>HUNGARY</b>	Zsolt CSAMPA Henriette Brigitte TAMAS Edina CZEGLÉDY Jeno KAMUTI
<b>ICELAND</b>	Represented by Bulgaria
<b>INDIA</b>	Rajeev MEHTA

<b>IRAN</b>	Alireza POURSALEMANI
<b>IRAQ</b>	Zeyad SALEEM Hasan AL-MUSAWI
<b>IRELAND</b>	Ursula KAPPUS Nuala MCGARRITY
<b>ITALY</b>	Maurizio RANDAZZO Vincenzo DE BARTOLOMEO Giandomenico VARALLO Giuseppe CAFIERO
<b>IVORY COAST</b>	Zadi Theodore GOGOUA
<b>JAMAICA</b>	James MCBEAN Rosa Elena ESCOBAR RAMOS
<b>JAPAN</b>	Kenichi CHIDA Kiyoshi WADA Yusuke AOKI
<b>JORDAN</b>	Naim DAHBOUR Hakam AL KAHLIDI
<b>KAZAKHSTAN</b>	Mirbulat ABUOV
<b>KENYA</b>	Fred KAMAU
<b>KYRGYZSTAN</b>	Represented by Mongolia
<b>KOREA</b>	Wan Kun OH Kiyoung KWON
<b>KUWAIT</b>	Abdulkarim ALSHAMLAN Alawadhi HAMAD
<b>LATVIA</b>	Erika AZE
<b>LEBANON</b>	Jihad SALAMEH Georges ZEIDAN
<b>LIBYA</b>	Dhw TOUMI Ezuldeen ALQADHI
<b>LITHUANIA</b>	Vytautas POLUJANSKAS
<b>LUXEMBOURG</b>	Pascal TESCH
<b>NORTH MACEDONIA</b>	Represented by Italy
<b>MACAO</b>	In Leng NG
<b>MADAGASCAR</b>	Represented by Guinea
<b>MALAYSIA</b>	Represented by Uzbekistan
<b>MAURITIUS</b>	Jennifer ISRAM Veena GUNPUT
<b>MOLDOVA</b>	Olga COJOCARI
<b>MONGOLIA</b>	Ganbaatar DORJSUREN
<b>MOROCCO</b>	Represented by Senegal
<b>MALI</b>	Wahabou ZOROME
<b>MAURITANIA</b>	Represented by Mali
<b>MYANMAR</b>	Represented by Nepal
<b>NAMIBIA</b>	Rainer VISSER
<b>NEPAL</b>	Sunil Kumar SHRESTHA

<b>NETHERLANDS</b>	Leon PIJNAPPEL Etienne VAN CANN Bert VAN DE FLIER (MH)
<b>NEW ZEALAND</b>	David ELDER
<b>NICARAGUA</b>	Represented by Costa Rica
<b>NIGER</b>	Represented by Burkina Faso
<b>NIGERIA</b>	Represented by Togo
<b>NORWAY</b>	Represented by Denmark
<b>OMAN</b>	Khalid ALSHUAIBI Khalid ALRAJHI
<b>PAKISTAN</b>	Salman CHOUDHRY Maryam SALMAN
<b>PALESTINE</b>	Dawoud MITWALI
<b>PANAMA</b>	Jorge VALDES
<b>PAPUA NEW GUINEA</b>	Represented by New Zealand
<b>PARAGUAY</b>	Miguel Angel PAREDES FASSINO Guido Manuel INSEFRAN MAYANS
<b>PERU</b>	Angel GARCIA
<b>PHILIPPINES</b>	Leah GONZALEZ Maria Cristina BATE
<b>POLAND</b>	Jacek SLUPSKI Tadeusz TOMASZEWSKI Jacek BIERKOWSKI (MH)
<b>PORTUGAL</b>	Clauso NEVES Frederico VALARINHO
<b>PUERTO RICO</b>	Juan Carlos RAMIREZ CONCEPCION Hipolito Antonio VAZQUEZ CORIANO Amgad BADAWI
<b>ROMANIA</b>	Marius FLOREA Roxana BARLADEANU Anca Ioana Ileana IONESCU
<b>RUSSIA</b>	Ilgar MAMEDOV Ekaterina KONDRATEVA
<b>RWANDA</b>	Represented by South Africa
<b>KINGDOM OF SAUDI ARABIA</b>	Ahmed ALSABBAN Abdullah ALSUNAID
<b>SENEGAL</b>	Mbagnick NDIAYE Oumar MAIGA
<b>SERBIA</b>	Vukasin STOSIC
<b>SLOVAK REPUBLIC</b>	Attila ERSEK
<b>SLOVENIA</b>	Represented by Croatia
<b>SOUTH AFRICA</b>	Louise LOMBARD
<b>SPAIN</b>	Antonio GARCIA HERNANDEZ Jose Luis ABAJO GOMEZ Marco Antonio RIOJA PEREZ Jose Luis ALVAREZ GIL DE TEJADA

<b>SRI LANKA</b>	Ajith SIYAMBALAPITIYA
<b>SWITZERLAND</b>	Lars Henrik FRAUCHIGER
<b>SWEDEN</b>	Otto DRAKENBERG Ana Verónica VALERO-COLLANTES
<b>SYRIA</b>	Ahmad ALREFAAI Hussain SHAKER
<b>CHINESE TAIPEI</b>	Kovacs LIN Jay LIU
<b>TAJIKISTAN</b>	Khisrav NASIMOV
<b>TURKMENISTAN</b>	Meret MEREDOV
<b>THAILAND</b>	Chanchai YOSSUNDARA Arnon KLUENSUWAN
<b>TOGO</b>	Katema Massaberma LAMEGA
<b>TUNISIA</b>	Mohamed Sofiane CHAOUACHI Ziad FERIANI
<b>TÜRKIYE</b>	Muminhan BILGIN Murat ATALI Abdussamet ARSLAN
<b>UKRAINE</b>	Mikhail ILYASHEV Olena SHEVCHUK
<b>UNITED ARAB EMIRATES</b>	HH. ENGR. Sheikh Salem Sultan S. AL QASIMI
<b>UNITED STATES OF AMERICA</b>	Ivan LEE Rita COMES Jennifer YAMIN Jeremy SUMMERS Donald ALPERSTEIN
<b>URUGUAY</b>	Diamante PEIRANO Lourdes TRAPOTE
<b>UZBEKISTAN</b>	Abdusamadov MAKHSUD Gulnora SAIDOVA
<b>VENEZUELA</b>	Francisco Rafael MARÍN ALVAREZ
<b>VIRGIN ISLANDS</b>	Represented by Aruba
<b>YEMEN</b>	Mohammad NASSER

## Agenda

1. Validation of attendances and proxies
2. Addresses
3. Ratification of new federations
4. Approval of the Report of the 2022 Congress held in Lausanne (SUI)
5. Approval of the Report of the 2023 Extraordinary Congress held online
6. Approval of the 2022 Annual Report of the Executive Committee
7. Financial report 2022, auditors' report, approval of the accounts, discharge to the Executive Committee and the auditors
8. Budget 2024
9. Appointment of the auditors for 2024
10. Vote to award the organisation of the World Championships:
  - 2025 Juniors/Cadets: candidatures of CHN/EST
  - 2025 Seniors: candidature of GEO
  - 2026 Juniors/Cadets: candidatures of BRA/UZB
  - 2026 Seniors: candidature of HKG
11. Call for candidatures for the organisation of the World Championships:
  - 2027 Juniors/Cadets
  - 2027 Seniors
  - 2025, 2026 and 2027 Veterans

*Coffee break*
12. Proposals submitted to the Congress, reports from the Commissions, Councils and Ethics Committee. Urgent decisions regarding the Rules  

*Congress photo and lunch*  
*Continuation of item 12*
13. Progress reports from the working groups
14. Proposals from the Ukrainian Fencing Federation  

*Coffee break*
15. 2023 Chevalier Feyerick Challenge
16. 2023 Fair-Play Trophy
17. Winners of the 2023 FIE official rankings and the Nations' Grand Prix
18. Any other business.  

*Final Remarks*  
*End of the Congress*



# 1. Validation of attendances and proxies

**Nathalie Rodriguez:** Good morning, everyone. We are going to start with the roll call. When I call your Federation, please raise your hand, and you will receive a voting device. After this, we will move to the proxies.

Algeria	Guinea	Palestine
Angola	Guam	Poland
Antigua and Barbuda	Guyana	Portugal
Antigua and Barbuda is not here?	Haiti	Puerto Rico
	Hong Kong, China	Qatar. Qatar. Is everything fine? Is anyone injured?
Armenia	Hungary	No. So, is Qatar here?
Argentina	Indonesia. Indonesia?	
Aruba	Indonesia is not here.	
Australia		Romania
Austria	India	South Africa
Azerbaijan	Iran	Russia
Bahamas	Ireland	Senegal
Barbados	Iraq	Serbia
Belgium	Italy	Sri Lanka
Botswana	Jamaica	Switzerland
Brazil	Jordan	Slovakia
Bahrain	Japan	Sweden
Brunei Darussalam	Kazakhstan	Syria
Bulgaria	Kenya	Thailand
Burkina Faso	Korea	Tajikistan
Cambodia	Saudi Arabia	Turkmenistan
Canada	Kuwait	Togo
Chile	Latvia	Chinese Taipei
China	Libya	Tunisia
Côte d'Ivoire	Lebanon	Türkiye
Cameroon	Lithuania	United Arab Emirates
Cape Verde	Luxembourg	Uganda. Uganda? Uganda is not here? So Uganda is not here.
Costa Rica	Macao	
Croatia	Moldova	
Cuba	Mongolia	
Czechia	Mali	Ukraine
Denmark	Mauritius	Uruguay
Ecuador	Namibia	USA
Egypt	Netherlands	Uzbekistan
El Salvador	Nepal	Venezuela
Spain	New Zealand	Vietnam. Vietnam? Not here? Vietnam is not here?
Estonia	Oman	
France	Pakistan	
Great Britain	Panama	Yemen
Georgia	Paraguay	
Germany	Peru	
Guatemala	Philippines	

Is there any Federation that I did not call? I am repeating those countries which did not answer.

Antigua and Barbuda, are you here? Not here.

Indonesia, are you here? Indonesia is not here.

Qatar, is Qatar here? Qatar is not here.

Uganda, is Uganda here? Uganda is not here.

Vietnam. Is Vietnam here? Vietnam is not here.

**Nathalie Rodriguez:** So, we will now move to the proxies.

- Afghanistan has given a proxy to Kazakhstan. Does Kazakhstan accept? Kazakhstan? Yes. You accept the proxy.
- American Samoa has given a proxy to Guam. Does Guam accept? Yes. Thank you.
- Benin has given a proxy to the Ivory Coast. Does the Ivory Coast accept? Yes.
- Belize has given a proxy to Uruguay. Does Uruguay accept? Where is Uruguay? Uruguay? So, you accept the proxy.
- Bolivia has given a proxy to Brazil. Does Brazil accept?
- Belarus has given a proxy to Russia. Does Russia accept?
- Congo has given a proxy to Cameroon. Does Cameroon accept?
- Colombia has given a proxy to Argentina. Does Argentina accept?
- Cyprus has given a proxy to Serbia. Does Serbia accept?
- Dominica has given a proxy to Peru. Does Peru accept?
- Ghana has given a proxy to Botswana. Does Botswana accept?
- Greece has given a proxy to Romania. Does Romania accept?
- Honduras has given a proxy to Venezuela. Does Venezuela accept?
- Iceland has given a proxy to Bulgaria. Does Bulgaria accept?
- Virgin Islands has given a proxy to Aruba. Does Aruba accept?
- Kyrgyzstan has given a proxy to Mongolia. Does Mongolia accept? Yes, there.
- Madagascar has given a proxy to Guinea. Does Guinea accept? Where is Guinea? There.
- Morocco has given a proxy to Senegal. Does Senegal accept? Yes.
- Malaysia has given a proxy to Uzbekistan. Does Uzbekistan accept? Yes.
- North Macedonia has given a proxy to Italy. Yes. Thank you.
- Mauritania has given a proxy to Mali. Does Mali accept?
- Myanmar has given a proxy to Nepal. Does Nepal accept? Yes.
- Nicaragua has given a proxy to Costa Rica. Does Costa Rica accept?
- Niger has given a proxy to Burkina Faso. Does Burkina Faso accept? Where is Burkina Faso? Here. Yes.
- Norway has given a proxy to Denmark. Does Denmark accept? Yes.
- Nigeria has given a proxy to Togo. Does Togo accept?
- Papua New Guinea has given a proxy to New Zealand. Does New Zealand accept?
- Rwanda has given a proxy to South Africa. Does South Africa accept? Okay.

So, this was the last proxy.

**Someone in the audience:** Excuse me, Nathalie.

**Nathalie Rodriguez:** To whom did you send it?

**Someone in the audience:** To Croatia.

**Nathalie Rodriguez:** But did you send it to us? Sorry, it is correct.

- Slovenia has given a proxy to Croatia. Sorry, it is correct. It was not printed.

**Nathalie Rodriguez:** So far, we have one hundred thirty-five Federations present or represented, which means one hundred six Federations present and twenty-nine Federations represented. But I am told that Antigua and Barbuda are on their way to come. So as soon as... they arrived, very good.

Now we have one hundred thirty-six present or represented with Antigua and Barbuda.

**Nathalie Rodriguez:** Sorry?

**Antonio Trcin (CRO):** May we have a voting box for Slovenia?

**Nathalie Rodriguez:** Yes, you will receive it. Please give a voting box to Croatia, who will vote for Slovenia. So, you should have two boxes.

**Nathalie Rodriguez:** If another Federation arrives, I will announce it. Before we move to the next item, I have some reminders for you.

As every year, the voting will be done electronically. You all have received the explanation on the voting device. The system is the same. It did not change. It guarantees that the votes are quick and secret, and the results of the votes will be displayed on the screen. Congress participants who wish to speak must ask for the floor and then come to the microphones installed in one of the hallways. Congress participants must announce their Federation and their name. During lunch, the Honour Commission will meet to propose the Challenge Chevalier Feyerick award. This Commission should consist of the Members of Honour present at the Congress and the Interim President.

I would also like to remind you regarding the majorities.

- The decisions of Congress are reached by a simple majority vote cast.
- The decisions of Congress regarding the Statutes are reached by two-thirds of the votes cast.
- The majority regarding the Rules is the simple majority of the votes cast.
- And in case Congress must, in exceptional cases, make a decision on issues that are not on the agenda and not planned by the Statutes, the decisions must be reached by a majority of three-fourths of the votes cast.

I would also like to remind you of the rules regarding speeches.

- For each item on the agenda, each President of a National Federation, or his/her representative, each Member of Honour and each Member of the Executive Committee can express their opinion a maximum of twice and for a maximum of two minutes each time.
- In addition, the Members of the Commissions, Councils, and Committees concerned by a specific item being discussed may express their opinion once, either by the President of the Commission, or by his or her representative, or with the agreement of the President of the Commission. Thank you.

## 2. Addresses

**Nathalie Rodriguez:** The floor is now to the Interim President for the *Addresses*.

**Emmanuel Katsiadakis (MH):** Thank you. Thank you, Nathalie.

Dear Members of Honour, Dear Members of the Executive Committee, Dear Members of Commissions and Councils, Dear Presidents and the Representatives of the National Federations, Dear Mr. President of the Egyptian Fencing Federation, Abdelmoneim Elhamy ElHusseiny, and Vice-President of International Fencing Federation,

On behalf of the International Fencing Federation, I am delighted to welcome you to the 2023 FIE Congress. We are happy to be able to have our Congress in person with the majority of the National Federations represented here today in order to serve our Mission – the development and promotion of fencing. As members of a sports organisation, we are here to deal with sports and fencing issues. In addition, in times of increasing tensions around the world, we are here to underline the strength of sports to bring people together.

Egypt has been the host country of the FIE events in the past with great success. As a host to our Congress this year, we can only anticipate an equally successful organisation and the warm hospitality we have experienced on all occasions. On behalf of the FIE and the FIE Executive Committee, I would like to express our sincere thanks to the Egyptian Fencing Federation, especially President Abdelmoneim Elhamy ElHusseiny. Also, warm thanks for all the support to the Egyptian government and especially to the Ministry of Sports, Dr. Ashraf Sobhy, who supports this project and provides economical organisation and substantial support. Thank you very much.

These are my opening remarks. I will continue after. I give the floor to the President of the Egyptian Fencing Federation, Mr. Abdelmoneim Elhamy ElHusseiny.

**Abdelmoneim Elhamy ElHusseiny (EGY):** Thank you, Mr. President.

In the name of God, the Most Gracious, the Most Merciful, I welcome you all to my country, Egypt. I am very happy to be with the distinguished FIE family.

I will give you some more time to deal with the translation. Today, I will speak in Arabic because in Egypt we speak in Arabic, so I will continue my speech in Arabic if you allow me.

Once again, may God's peace, mercy, and blessings be upon you. I welcome you all to my country, Egypt, and I express my gratitude and happiness that I am here today among my large family, the international fencing family.

During the last period, Egypt has hosted major events in the sport of fencing. Starting in 2019, we hosted the Veterans' World Championships. In 2021, we hosted the Junior World Championships. Under very difficult circumstances related to COVID-19 in 2022, we hosted the Senior World Championships, and today, we are hosting the international FIE family at the Congress in the city of Sharm El-Sheikh, the city of peace.

I wish you all a happy stay in Egypt, and I hope that our meeting today as one family will be a purely sports meeting, and God willing, it will be a successful meeting. A successful one! Thank you once again, and welcome to Egypt. Thank you.

*Applause.*

## **Video-address of the Minister of Youth and Sports of the Arab Republic of Egypt**

Ladies and Gentlemen,  
Dear guests of Egypt,

I would like to express my great happiness and pride in announcing that Egypt will host the activities of the meeting of the Executive Committee and the Congress of the International Fencing Federation in one of the most important and famous tourist cities in the world. Al Salam City, Sharm El-Sheikh, on November 24 and 25.

Hosting these events certainly reflects Egypt's strong commitment to promoting sports and sporting heritage overall. It also signifies an unparalleled leap and remarkable development in the Egyptian sports system during the era of the new Egyptian Republic. This progress is thanks to the comprehensive support and sponsorship provided by His Excellency President Abdel Fattah El-Sisi.

We are proud to host such important meetings for the first time in Sharm El Sheikh and in Egypt.

I would like to thank President Abdel Moneim Al-Husseini, President of the Egyptian Fencing Federation, Vice-President of the International Fencing Federation and the Board of Directors of the Egyptian Fencing Federation, for their tremendous efforts in developing the sport, promoting its dissemination, and actively contributing to supporting the international fencing community. This is based on the strong relationships and trust that the Egyptian sports system enjoys on the global level.

I want to mention here that the Egyptian government, working in collaboration with the Ministry of Youth and Sports and the Egyptian Fencing Federation, has spared no effort to ensure the success of this event by providing all the necessary facilities. I would like to confirm that Egypt is fully prepared to host the various events and competitions of the International Fencing Federation and provide an ideal experience for all attendees.

The fact that Egypt is hosting this meeting, along with the Executive Committee and Congress Sessions of the International Fencing Federation, and various other meetings during this significant event, including those of the African Union and the Arab Union, highlights Egypt's commitment to fostering international sports collaboration and strengthening connections between nations and sports organisations.

I would like to thank the President of the International Fencing Federation, Mr. Emmanuel Katsiadakis, for attending this event. I would also like to thank General Khaled Fouda, the Governor of South Sinai, for his support and collaboration in hosting this event, along with other sporting activities in Al Fayrouz

In conclusion, I express my sincere gratitude to all the participants from different countries worldwide in the Executive Committee and Congress meetings of the International Fencing Federation. We wish you a pleasant stay in your country, Egypt, and wish your meetings every success.

Thank you all.

*Applause.*

### **Emmanuel Katsiadakis (MH):**

Dear Colleagues, now we go to the real Congress discussion.



Let me repeat, it is a true pleasure to have you here at this Congress in Egypt, in this beautiful place. This is an opportunity to have a discussion about fencing and the International Fencing Federation and make decisions for the sole and best interest of the sport of fencing.

Several crises and the unstable international situation have been affecting countries and individuals around the world. The sports world and fencing have also been affected. The FIE has been exposed to an unprecedented situation, working on serious and sensitive issues that had required particular attention. In order to deal with these issues, the FIE had to be involved in the CAS (Court of Arbitration for Sport) and Lausanne Tribunal for the cases raised by the Ukrainian Fencing Federation, supported by Swedish and Finnish Federations, the IOC Ethics Commission, and the FIE Ethics Committee, some individuals' and National Federations' statements in media. Some National Federations do not respect and challenge the democratic decisions taken by Congress; individuals, unfortunately, who sent anonymous death threats to our staff.

If we look at the demands on the FIE, I am sure everyone in this hall will recognize the strain under which it has worked. Hopefully, you will also recognize the amount of time, work, energy, and dedication these situations required.

To eliminate any potential ambiguity, the FIE is recognized as an active, faithful, and conscientious member of the International Olympic Committee, following the IOC's directives, and rigorously pursuing the Olympic values and spirit. In many of our decisions, we need to implement the recommendations or decisions of the Olympic movement. Nevertheless, we always act in compliance with the FIE Statutes, the FIE Rules, and the Administrative Rules of the FIE. The FIE always implemented the principle of non-discrimination so that no fencers would be deprived of participating in the FIE competitions. As a basic principle for the FIE, competitions and events, they are assigned only to the National Member Federations which ensure free access to all competitors and officials as provided in Chapter 9 of the FIE Administrative Rules. The FIE has been constantly working and fighting to absorb the negative pressure while ensuring a fully efficient environment as a result.

The FIE was fully functional. The FIE Executive Committee met on numerous occasions to address all issues and manage the FIE. The FIE implemented the IOC recommendations and directives as advised by many Federations during the 2022 Congress. The FIE online extraordinary Congress was successfully and validly held. The FIE held a successful World Championships in Milan, one of the best of the last years. All exciting programmes of the FIE were implemented: organisation of events, broadcasting, promotion of events, preparation of the 2024 Olympic Games, reporting and providing all the required information to the IOC and to LA 2028 in view of the inclusion of fencing in this competition; academies, equipment support, financial support of Federations and Confederations, etc. Therefore, I would like to state it in very clear terms. The FIE is a non-governmental and autonomous sport organisation. It is not a political organisation. I repeat it: it is not a political organisation. Its mission, which is recognized by the IOC, is to manage the sport of fencing worldwide. The FIE Congress has to deal with sports and fencing issues. There is no room for unfair and divisive interventions with the sole aim of serving interests. We must not allow anyone to damage the reputation, reliability, and autonomous status of the FIE. We must not import conflicts in the world into our community. All of us are in the same family, the fencing family. We should not forget that in its history, the fencing family has overcome all challenges thanks to the values of common sense, goodwill, friendship, fair play, and mutual respect. We must, we must therefore be an example. Sport is a powerful tool for unity and peace for now and for the future. With your permission, I will stop here. Thank you very much.

*Applause.*

### 3. Ratification of the New Federations

**Nathalie Rodriguez:** The next item on the agenda is the *Ratification of New Federations*. Yesterday, the Executive Committee approved the provisional affiliation of the Federation of Montenegro. And we would like to ask Congress to approve this new Federation in the FIE.

So, if you agree, we will move to the vote to provide final affiliation to the Federation of Montenegro. The vote is open.

The vote is closed.

The Federation of Montenegro is a new member of the FIE.

*Applause.*

I would like to highlight an item that the Interim President could not say at the end of his speech that this year...

**Ana Irene Delgado Guerra (PAN):** Excuse me, Nathalie.

**Someone in the audience:** They [Some Federations] did not vote.

*[Discussion in the audience]*

**Nathalie Rodriguez:** We are asking the Federations to vote. We cannot force you to vote, but you came here for this.

*[Discussion in the audience]*

**Nathalie Rodriguez:** Sorry.

*[Discussion in the audience]*

**Nathalie Rodriguez:** Do you mean that you had to press *valid* twice?

**Someone in the audience:** Yes.

**Nathalie Rodriguez:** Why? Because the first time it did not work?

*[Discussion in the audience]*

**Nathalie Rodriguez:** Okay, can we reopen the vote on this, and we will see.

*[Discussions in the audience]*

**Nathalie Rodriguez:** The vote is open; we reopen the vote on the same item. So, when you vote *yes* or *no* or *abstention*, you have to press *valid* twice. Is that correct, Mr. Modoux?

**Emmanuel Katsiadakis (MH):** What is the matter?

**Nathalie Rodriguez:** No, you have to press *valid*.

*[Discussions in the audience]*

**Nathalie Rodriguez:** When we do a test vote and will open again. So, when you will vote, You will press *1*,

2 or 3. Then wait until you see *yes* or *no* or something else on your screen. Then you will press *valid*. But you have to wait until it displays on the screen, on your screen.

Do you still have any problem? Sir, if you want to speak, please take the microphone because I cannot hear you from here. That gentleman says that he has a problem. Here.

**Someone in the audience:** I have a question, if I can vote...and then I press it. It is good, yes, and then I must press it again. And then, at this point ...

**Nathalie Rodriguez:** Okay, please, stay here. Close the voting and reopen the test voting.

I will test it myself. So, we reopen the voting. I press *1*. So, it is twice. It is twice. It is not two votes, but you have to confirm twice. I tested myself, and it is true. But, but only one vote. Maybe we can reopen the vote on the ratification of the Montenegro Federation. So, let's close this vote. We finish with this vote, and you re-vote for Montenegro. And please vote. If you have received a voting device, it is because you have to vote.

So, the vote is closed.

*[Discussions and exclamations in the audience]*

**Nathalie Rodriguez:** Tell me what was not clear when I said, "Please vote." Shall I push each button on each box so that you vote? Please.

So, Montenegro was approved, but at least we had zero *no* and zero *abstention*, at least. Yes, Sir.

Microphone, please.

**Someone in the audience:** Can I suggest that we are shown an image of what to get? I sat next to the Bahamas, and when the vote was open his screen was totally different from mine. So, when he pressed his screen, and I pressed mine, and that happened over there, we saw two totally different scenarios. I have voted three times, my screen has looked different every single time, and I am voting correctly.

**Nathalie Rodriguez:** Maybe you should change your voting device. Maybe the voting device is damaged.

**Someone in the audience:** Well, I do not mind doing that, but if somebody can say what we are supposed to see on the screen at each move that might assist everybody.

**Nathalie Rodriguez:** As I said, you will have the word *vote* on your screen. Then you have to press *valid*. Then you press *1*, *2*, or *3*, and then *valid* a second time. But change your box in case the box is damaged.

## 4. Approval of the Report of the 2022 Congress held in Lausanne (SUI)

**Nathalie Rodriguez:** The next item on the agenda is the *Approval of The Report of the 2022 Congress held in Lausanne*. Yes, please.

**Hilary Philbin (GBR):** Nathalie, for the last vote, we had 117 votes. But at the top of the screen, it said the majority was 59, but surely it should have been 58.

**Nathalie Rodriguez:** But it is the majority.

**Hilary Philbin (GBR):** 58 would still be a majority, would it not?

**Nathalie Rodriguez:** 58 is not the majority.

**Hilary Philbin (GBR):** Okay, fine.

**Nathalie Rodriguez:** We will open the vote on item #4 of the agenda, the Approval of the 2022 Congress Report. The Congress was held in...

**Yann Bernard (CAN):** Nathalie?

**Nathalie Rodriguez:** Yes.

**Yann Bernard (CAN):** I am Yann Bernard from Canada. Before the vote on the Report of the Lausanne 2022 Congress, I note that the votes were reported but without giving the figures. So, from a simple report, it is impossible to know by what majority or how many people voted for, voted against, or abstained. I see people have translation devices that do not work.

**Nathalie Rodriguez:** Translators, please. Did the translation start or not?

**Persons in the audience:** No, no, no.

**Nathalie Rodriguez:** Okay, I will translate it into English. It is better. Ah, it is starting. Okay.

**Yann Bernard (CAN):** All right, so I will start again. I am Yann Bernard from Canada. I noticed that in the 2022 Report, the voting results were reported as the proposal passed or the proposal was rejected, but the number of votes was not reported. I know from having spoken to you about it that we have this data. I suggest that we include in an annex for each proposal adopted, rejected, etc., the number of votes because sometimes, when we re-read the acts of Congress a few years later or a year later, it may be important to know whether it was mainly approved or almost defeated. In short, it is customary in these official documents to keep a record of the number of votes.

**Nathalie Rodriguez:** This is true. We discussed this item yesterday, so I said that the future reports of the Congresses will include all the reports provided by electronic voting as an annex to the Congress report. However, I would like to highlight that it has been like this for a while. We have never provided the results of votes in the past Congresses. This is the first time we have had this request, but it is fine. We will include all the results for

each vote as an annex to the Congress report, as provided by the company in charge of the votes. So, we will include this information in the report, starting with the report of this year.

So, we open the vote.

The vote is closed.

The report is approved.



## 5. Approval of the Report of the 2023 Extraordinary Congress held online

**Nathalie Rodriguez:** The next item on the agenda is item #5, the *Approval of The Report of the 2023 Extraordinary Congress held online*.

We are going to open the vote on this item.

The vote is open.

The vote is closed.

The report is approved.

## 6. Approval of the 2022 Annual Report of the Executive Committee

**Nathalie Rodriguez:** The next item on the agenda is the *Approval of the 2022 Annual Report of the Executive Committee*, and the floor is to the Interim President.

**Emmanuel Katsiadakis (MH):** I believe that you all have the report. And we tried, during this year, as I said in my speech, I had not finished the last few words when I handed it over to Nathalie, to make a lot of work, incredible work during this year. Also, with the help of the International Olympic Committee because we are a very close member of it. We did a lot of work, and we went through these difficult sequences this year, and will ensure that our Federation will advance. I do not know if anyone would like to ask anything, but I think even under these difficulties, it was still a good year for our sport.

I would like to inform you that during the past year, we lost many of friends from our family. I want to ask you to stand up for a minute of silence in memory of these people, these friends in fencing.

*(Movie and a minute of silence.)*

**Emmanuel Katsiadakis (MH):** Thank you very much. There are too many.

**Nathalie Rodriguez:** We are going to open the vote on the *Approval of the 2022 Annual Report of the Executive Committee*.

We open the vote.

The vote is open.

The vote is closed.

The report is approved.

## 7. Financial report 2022, auditors' report, approval of the accounts, discharge to the Executive Committee and the auditors

**Nathalie Rodriguez:** The next item is item #7. It is the *Financial report 2022, auditors' report, the approval of the accounts*. And the floor is to the Secretary-Treasurer.

**Ferial Salhi (ALG):** Hello, everybody! You have all received the financial documents for the 2022 financial year. I will speak more slowly. Perhaps you did not have the translation. We started with a budget of more than 10 million Swiss francs. We spent 7,741,541 CHF. Do you have a translation?

**People in the audience:** No, No.

**Ferial Salhi (ALG):** Now, yes? In English, it is not easy. French translation is working now. So, we had a budget of 10 million Swiss francs, and we only spent 7,741,541 CHF. We ended up with a capital of 29 million Swiss francs. I would like to know if you have any questions to ask and if you have received the auditors' report as well. So, if you do not have any questions to ask, we can vote.

**Nathalie Rodriguez:** So, if you have no questions, we can move to the vote on the 2022 Financial report, the report of the auditors, the approval of the accounts, and discharge to the Executive Committee and the auditors.

The vote is open.

The vote is closed.

The accounts are approved.

## 8. Budget 2024

**Nathalie Rodriguez:** The next item is item #8, *Budget 2024*, and the floor is to the Secretary-Treasurer.

**Ferial Salhi (ALG):** With the Executive Committee, we have lowered the budget for the year 2024. We will have a budget of 6,950,000 CHF. All the programmes of the International Federation related to the sports department will be maintained.

We have lowered administration costs. And I hope we do not have additional expenses like we had this year on legal fees and so on. So, we are going to start with a budget of 6,950,000 CHF. Do you have any questions?

**Nathalie Rodriguez:** Okay, so we can move to the vote on this item. And we open the vote on *the 2024 Budget*.

The vote is closed.

The budget is approved.

## 9. Appointment of the auditors for 2024

**Nathalie Rodriguez:** The next item is the *Appointment of the auditors for 2024*, item #9, and the proposal is to renew Ernst & Young for another year. We open... Yes.

**Yann Bernard (CAN):** Does the microphone work? I represent Canada; my name is Yann Bernard. My question is more aimed at our Treasurer. I noted from the official documents from last year that Ernst & Young have been our auditor for many years. The question is: isn't it good governance from time to time to consider different auditors to ensure even greater autonomy and an even greater image of independence? Is there a process to receive submissions to reassess whether it is possible to use other auditors from time to time? It is very important for me to emphasize that this question is in no way intended to raise doubts about the way our finances are managed, nor about the work of our current auditors.

**Ferial Salhi (ALG):** Indeed, we could choose other auditors, but it is the Congress that decides. The decision is up to Congress to renew confidence in our auditors or to select others.

**Nathalie Rodriguez:** This is the reason we are asking Congress to renew them, or not.

**Yann Bernard (CAN):** Yes, however, I understand that there is only one option presented to Congress, and generally, for Congress to be able to decide to select another company, it would be necessary to have an idea of the cost. Is it more expensive, what kind of company is it? There is really no other option before Congress today than to vote *yes* or *no* and put itself in a difficult position of not having an appointed auditor.

**Nathalie Rodriguez:** I think that for the future, if you wish us to present several companies, you should tell us in advance, maybe not on the day of the Congress when the Executive Committee comes up with a proposal. You know, Ernst & Young is a very reputable company that has always been very strict, we worked hard at the FIE and they will not let us do anything wrong. If you want to change company, why do not you propose other companies? And why did not you approach us with that proposal before the Congress? I do not mind changing.

**Yann Bernard (CAN):** This is not a proposal; I am asking if the organisation itself could simply think about it.

**Nathalie Rodriguez:** In that case, please, send us that kind of proposal in advance.

**Yann Bernard (CAN):** So, I am doing it now. I suggest that a reflection with a view to next year be made on the part of our finance managers. This is the only aim of my remarks.

**Nathalie Rodriguez:** Okay, so for next year, we will ask the other auditors for quotes, and analyse what the FIE's costs will be, and then we will come with that proposal to the Congress.

**Ferial Salhi (ALG):** But you should know that Ernst & Young are the auditors of most of the International Federations. So, they have been chosen for that reason.

**Nathalie Rodriguez:** Thank you, so we open the vote on the appointment of Ernst & Young as auditors for next year, for a one-year term.

And the vote is open.

The vote is closed.

So, Ernst & Young will be happy to know that they have been renewed for 2024.



## 10. Vote to award the organisation of the World Championships:

- **2025 Juniors/Cadets: candidatures of CHN/EST**
- **2025 Seniors: candidature of GEO**
- **2026 Juniors/Cadets: candidatures of BRA/UZB**
- **2026 Seniors: candidature of HKG**

**Nathalie Rodriguez:** We move to the next item, which is item #10, the *Vote to award the organisation of the World Championships*.

So, we will have to vote on:

- The Junior and Cadet 2025 World Championships. We have the candidatures of the Federations of China and Estonia.
- For 2025 still, the Senior World Championships, we have the candidature of Georgia.
- For the 2026 Junior and Cadet World Championships, we have the candidatures of the Federations of Brazil and Uzbekistan.
- And for 2026, Senior World Championships, we have the candidature of the Federation of Hong Kong, China.

In order to determine who is going to present first and who will be second, I would like to invite the Federations of China, Estonia, Brazil, and Uzbekistan to come here to the Tribune. We will make a draw.

**Nathalie Rodriguez:** There is an announcement, I think, for the 2026 Junior and Cadet World Championships, regarding the candidatures of Brazil and Uzbekistan. Mr. Logvin and Sheikh Salem want to make an announcement.

**Vitaly Logvin (MEX):** Good morning, Dear President, Dear Members of the Executive Committee, Dear Delegates. Yesterday, the two leaders of the Pan-American Fencing Confederation and the Asian Fencing Confederation, joined by the National Fencing Federation of Uzbekistan; we were looking at the situation for those candidates for the next World Championships. The reason is that we are looking at two candidates from Asia for 2025 and 2026, sat down and friendly made a decision with the National Fencing Federation of Uzbekistan and Gulnora Saidova, who you know very well. She is an intelligent woman who is working a lot for the development of fencing in Asia, and also around the world. She will make an announcement for you right now, explaining what we have decided on a friendly basis, because what is more important is that it was decided friendly, in the big family of fencing, and that we prefer to compete on the piste. So, we decided which candidate should be nominated for the next World Championships, and it was a friendly decision. Gulnora, please.

**Gulnora Saidova (UZB):** Good morning, Everybody. Firstly, I am really pleased to be here and to meet many friends from around the world. As you know, we were the candidates for the 2026 Junior and Cadet World Championships. But we clearly understand that the competition should be organised not only in one country or part of the world, but around the world. So, we decided to give our voice, our right to organise the next World Championships, and cancel our candidature in favour of Brazil. Thank you.

*Applause.*

**Sheikh Salem Sultan S. Al Qasimi (UAE):** I want to add one point. I want to thank the Uzbekistan Fencing Federation for their cooperation and for supporting Brazil in hosting the competition. Thank you. Thank you very much.

*Applause.*

**Nathalie Rodriguez:** Thank you.

*Applause.*

**Ricardo Pacheco Machado (BRA):** Good morning! For us, Uzbekistan's position is a great pleasure and surprise. We are ready to hold a very nice, very beautiful competition, in the same place where we held the Olympic Games. So, thank you very much, Uzbekistan. See you all in 2026. Thank you.

*Applause.*

**Nathalie Rodriguez:** So, we will now move to the presentations of the 2025 Junior and Cadet World Championships. Estonia will present first, and China will present second. I ask the representatives of the Federation of Estonia to come. Sorry, I did not see you.

### **Presentation of Estonia**

**Heino Märks (EST):** Thank you. Dear Fencing Friends, my name is Heino Märks, and I represent the Estonian Fencing Federation. So, I will continue in English. Could you please start this slideshow?

*[Video presentation]*

Please start PowerPoint. We had two. There was a PowerPoint presentation.

**Nathalie Rodriguez:** Can we have the second presentation?

**Heino Märks (EST):** It is lost in space. It is okay. I can just say a few things. Okay, PowerPoint seems to be lost in space. I will highlight some topics.

**Flights.** We have very good flight connections to get to Tallinn. We have many daily flights from Istanbul, Amsterdam, Paris, London, Frankfurt, Copenhagen, Stockholm, Helsinki, Oslo, and Riga. Especially if you come from Asia, we have the right flights via Helsinki. You get your flight to Helsinki, and it is 15 minutes from Helsinki to Tallinn.

**Accommodation and Transportation.** The competition venue is 10 minutes by car from the airport to the accommodation of the official hotels. A three-star hotel is located 252 meters from the venue, and four-star hotels are about 500 meters from the venue. No local transportation is needed, and we have more than 1,500 beds in those hotels. And if any extra rooms are needed, we have other hotels in Tallinn, one three-star hotel with more than 300 rooms and two four-star hotels, and transportation will take about five minutes.

**Prices.** You will find the prices in our bid documents: a single room in a three-star hotel is approximately 80 euros and a double room is 90 euros. The four-star rate is about 100-110 euros, depending on the level. Movenpick is a bit more expensive. So, if you have any questions, I can shortly answer them so as not to delay my Chinese colleague's presentation. Thank you. Thank you very much.

*Applause.*

**Nathalie Rodriguez:** Thank you very much. We now request that the Federation of China come to the speaker's booth.

### **Presentation of China**

**Haibin Wang (CHN):** First, I want to invite our delegate from the city of Wuxi.

*Applause.*

**Haibin Wang (CHN):** Dear Interim President, Dear All Colleagues, Dear International Fencing Family, it is a great honour to be here to introduce the city of Wuxi as a candidate for the 2025 Junior and Cadet World Championships. As many of you already know, Wuxi is a fencing city that has successfully organized large international competition events, including the 2018 Senior World Championships, the 2023 Senior Asian Championships, and others. In addition, the City of Wuxi is not only known for organizing competitions but will also become the center of fencing protection, manufacturing, innovation, and fencing education in the future. So today, I am honoured to introduce the city of Wuxi. Please watch the videos.

**Nathalie Rodriguez:** Some seconds of patience, thank you very much.

**Haibin Wang (CHN):** Sorry about these technical issues.

*Video presentation.*

*Applause.*

**Haibin Wang (CHN):** Thank you. Today, we open a new chapter. We continue to face challenges for the continued support of international fencing and global fencing. Now let me introduce Mr. Wu Wen-Lung, Deputy Secretary-General of Wuxi People's Government. Please.

*Applause.*

**Wu Wen-Lung (CHN):** Ladies and Gentlemen, good morning. Sorry for some problems with our video, but we will give you a good presentation later. Thank you.

It gives me a great honour to make a presentation on behalf of Wuxi, China, located in the Chinese Yangtze River delta. Wuxi is adjacent to Shanghai and is crowned as the shining "Pearl of Taihu Lake", a prosperous land of the Jiangnan region with a long history, magnificent natural scenery, and economic prosperity. Wuxi has been vigorously developing fencing sports, especially for teenagers. A total of 30 primary schools offers fencing courses.

In 2018, we successfully hosted the Fencing World Championships, which presented spectators around the world with a top fencing piste, a full-fledged venue, hospitality, high-level services, and orderly organisation. Our confidence also comes from the successful hosting of the 2022 National Fencing Championships and the 2023 Asian Fencing Championships, as well as many other large international sports events.

We sincerely wish the FIE will award Wuxi the 2025 Junior and Cadet Fencing World Championships. And we will spare no effort to create a safe, wonderful, and successful event.

**First, the Venue and the Facilities.** Wuxi owns a competition mansion covering over 40,000 square meters, which enjoys first-class conditions, including various types of function rooms and well-equipped facilities.

**Second, Accommodation and Reception.** Situated in the most flourishing area of Wuxi, the renewed abundant resources of hotels are in its surroundings, and it sees a number of star-rated hotels nearby.

**Third, Transportation Conditions.** Wuxi has built a sound, comprehensive transport system comprising an international airport, several railway stations, sufficient buses, and subways, which facilitate the provision of convenient transportation.

**Fourth, Security and Medical Services.** Wuxi is one of China's best cities in terms of public security and is home to several high-level hospitals, which are capable of providing first-rate international medical services.

**Fifth, Sightseeing and Tourism.** Wuxi is bestowed with rich tourism resources and numerous scenic spots and hospitable citizens. It is one of the most popular tourist destinations in China. We sincerely invite all participating teams to go on a tour of Wuxi city.

**Six, Competition Time.** We suggest the 2025 Junior and Cadet Fencing World Championships be scheduled for April in accordance with formal practice, but the exact time is subject to the arrangements of the FIE.

Ladies and Gentlemen, it is a common aspiration of 7.5 million people of Wuxi to host the 2025 Junior and Cadet Fencing World Championships.

Welcome to Wuxi! Welcome to China! Welcome to Asia!

Thank you all very much.

*Applause.*

**Nathalie Rodriguez:** Thank you very much. And now we will move to the vote.

- If you want to vote for the candidature of China, you press 1.
- If you want to vote for the candidature of Estonia, you press 2.
- And press *valid, valid.*

The vote is open.

**Ben Daouda Nass (GUI):** Hello.

**Ana Irene Delgado Guerra (PAN):** Nathalie, he wants to speak.

**Nathalie Rodriguez:** Yes.

**Ben Daouda Nass (GUI):** Okay. The voting has started. I have a little problem. First, I have to vote twice, for myself and for Madagascar.

**Nathalie Rodriguez:** You have received two boxes.

**Ben Daouda Nass (GUI):** No. No, I received...

**Nathalie Rodriguez:** You did not receive two boxes?

**Ben Daouda Nass (GUI):** I only received one.

**Nathalie Rodriguez:** Well, we will give you a second one.

**Ben Daouda Nass (GUI):** Can you give it to me now?

**Nathalie Rodriguez:** This is not a problem.

**Ben Daouda Nass (GUI):** Okay.

**Nathalie Rodriguez:** The vote is closed. China has been chosen for the organisation of the 2025 Junior and Cadet World Championships.

*Applause.*

We now move to Georgia's candidature for the Senior 2025 World Championships, and I ask the representative of Georgia to come to the Tribune. Yes, please.

### **Presentation of Georgia**

**Nino Jerenashvili (GEO):** Good afternoon, Mr. President, and Mrs. Nathalie Rodriguez.

**Nathalie Rodriguez:** Push the microphone's button.

**Nino Jerenashvili (GEO):** Dear Mr. President, Dear Mrs. Nathalie Rodriguez, Distinguished Delegates, Ladies and Gentlemen, I represent the Georgian Fencing Federation. I am Nino Jerenashvili, Secretary-General, and I would like to present to you this short, brief presentation about the Senior World Championships 2025.

The first question is: Why is the Georgian Fencing Federation going to present such a great competition? Because the World Championships is the highest sports competition, its holding is of great importance for our country. Firstly, fencing will become more popular as leading countries of the whole world will come to Georgia. Secondly, it is an opportunity for us to show our strengths and that we can host such a great event and hold this event in Tbilisi. Also, we have the great experience of holding two such competitions as U-23. In 2017, we organised the Senior European Championships. After 2020, it was a very difficult situation because of COVID. So, after that, when many European countries cancelled World Cups, we tried to organise such events in Tbilisi. So, we think it is our chance to hold the World Championships in Tbilisi.

As I already said, the host city will be Tbilisi, the capital of Georgia, and one of the municipalities located in the Eastern part of Georgia, in the Tbilisi basin. Tbilisi is one of the oldest European capitals and has been a cultural, political, and economic centre.

We are going to hold this event in the new Sports Palace, which is located near the high-rise building of the Tbilisi State University. It has three halls: one hall seats 3,600 spectators, the second hall – 600, and the third – 10,000 spectators.

We have two airports in Georgia. The biggest is Shota Rustaveli Tbilisi International Airport. The second is Kutaisi International Airport, near Tbilisi, approximately two hours away. The Kutaisi International Airport services flights of Wizz Air, which is a low-cost company. Wizz Air has direct flights to Kutaisi from many countries, such as Hungary, Spain, and others. We will be very happy if you approve our candidature, and the World Championships will be in Tbilisi in 2025. Now, I want to play a short clip about Tbilisi. Please start the clip.

*[Video presentation]*

Thank you very much for your attention.

*Applause.*

**Nathalie Rodriguez:** Thank you. We are now moving to the vote.

We open the vote on Georgia's candidature for the 2025 Senior World Championships.

The vote is open.

The vote is closed.

Georgia is awarded the 2025 Senior World Championships.

*Applause.*

**Nathalie Rodriguez:** Thank you. We move to the 2026 Junior and Cadet Championships, and we have the candidature of Brazil. Brazil is requested to come and make its presentation. Thank you very much.

### **Presentation of Brazil**

**Ricardo Pacheco Machado (BRA):** Good morning, once again. Also thank you, once again, thank you very much, Uzbekistan, for having renounced the candidacy in favour of Brazil. For us, it is an honour. I am the President of the Brazilian Confederation. Vice President Arno Schneider will make the presentation.

**Arno Perillier Schneider (BRA):** Thank you, everyone.

First of all, welcome to Brazil 2026! One of the most beautiful sceneries in the world, the city of Rio de Janeiro, is known not only for the beach and enjoyment of views of the mountains and the tropical climate, but also for the people known for their hospitality. We really enjoy having not only fencing but also sports events inside of Brazil. Next slide, please.

**Rio de Janeiro.** Today, the city of Rio de Janeiro has around 6 million people. It has tropical weather, and temperatures range between 24-25 degrees in the World Championships season. It is an iconic tourist place, and we genuinely enjoy hosting all the nations inside Brazil. And to let you know, Brazil has no problems issuing a visa for all the countries of the world. Next slide.

We have an international airport with flights for many regions of the world: Europe, all of America, and Asian-directed flights. The only issue is Oceania. We do not have direct flights, but you can transfer inside of Europe or Asia to come to Brazil. Next one.

We have quite a history, not only in fencing but also in sports events. In Brazil, we organised the Olympic Games, the Paralympic Games, especially in Rio, the World Cups, the Grand Prix, the World Championships for team events in 2016, and also the Military Games and the soccer World Cup. Next slide.

**Olympic Park.** The part that most countries largely know is the Olympic Park, which is the legacy of the Games. We will use two Arenas. We hosted basketball and judo during the Games. It is Carioca Arena 2 and Carioca Arena 1. Carioca Arena 1 seats around 10,000 if it is at its full capacity. Next one.

This is the place where we hosted fencing and where we hosted basketball during the Rio 2016 events. For the Paralympics, also, we had wheelchair fencing and hockey for wheelchairs. Next one, please.

**The infrastructure.** We have three, four, and five-star hotels around the Arena within only 10 minutes distance. It makes the transportation situation very easy after arrival in Rio. The food is very accommodating for the majority of countries. We have different kinds of cuisine as well as international food inside, especially in Barra da Tijuca, that will be the place for the World Championships. Next one, please.

The competition will be held between April 3rd and April 12th, 2026. In the Carioca Arena 1, we will have the semifinals, finals, and direct elimination. And at the Carioca 2, we will have the pools and the first qualifiers.

The capacity for the people is around 3,100 people in Carioca 2, you can see the seats, and there will be free entrance. Next one.

Now, a small video to enjoy a bit of Rio.

*Video presentation.*  
*Applause.*

Welcome to Rio de Janeiro and thank you again to Uzbekistan!

*Applause.*

**Nathalie Rodriguez:** We will now move to the vote on the 2026 Junior and Cadet World Championships with the Brazil's candidature and the vote is open.

The vote is closed.

Brazil will organise the 2026 Junior and Cadet World Championships.

*Applause.*

**Nathalie Rodriguez:** We move to the presentation of the candidature of Hong Kong, China, for the 2026 Senior World Championships.

### **Presentation of Hong Kong, China**

**Wing Sun Yeung (HKG):** President and the Executive Committee of the FIE, All the Fencing Federations of the world, I am proud and happy to be here to present our 2026 World Fencing Championships in Hong Kong. Ever since I proposed that we try to host the 2026 Fencing Championships a couple of years ago, we were

all very excited, and everything was under preparation. Now, we even got more support from the government as our new Chief Executive of Hong Kong has decided to support more international events. So, we are really happy about that.

Hong Kong is an international city, easy to access by everybody. So, I trust this will be a convenient space for everybody to come. To keep everything short, let me present a little bit about our venue.

Our venue will be the AsiaWorld-Expo, which is just right next to the airport. It is very close to the airport. And then, there are four or five hotels all around the airport area. From the airport area to downtown Hong Kong, it takes only about 26 minutes of a train ride, so it is very close and convenient.

We will be hosting our events at the World Expo. We have rented more than 30,000 square feet or square meters of floor space. As you can see, we have a training hall, a preliminary hall, and a final hall. The final hall is a large hall with an auditorium for over 10,000 people, but of course, we are not going to use it all. Maybe I will just show you the floor plan of the venue. Next slide, please. Okay.

As you can see on the far right, that is our final hall; then, we have a training hall and a preliminary hall altogether. And I will show you more details. The following slide, please.

This will be our training hall with 24 training pistes and all the rooms for the National teams. So, this is about 8,000 square meters. Next slide, please.

Just the floor plan of the training hall. Next slide, please.

In the preliminary hall, we have over 10,000 square meters for the competition with 32 pistes. Next, please.

This is the layout of the preliminary hall. Next, please.

This will be our final hall, which is over 10,000 square meters. And please, next.

We will have the final area on the left and the warm-up training area on the right side. Next. Is it all? No. Yes. Okay, that is all on the floor plan and everything. And now we are going to show the venue.

*Video presentation.*

This will be all for my presentation. I hope you enjoyed it, and we are looking forward to seeing you all in Hong Kong in 2026.

*Applause.*

**Nathalie Rodriguez:** Thank you very much.

We will now open the vote on the candidature for the 2026 Senior World Championships, and the vote is open. The vote is closed.

Hong Kong, China, will organise the 2026 Senior World Championships.

*Applause.*



## 11. Call for candidatures for the organisation of the World Championships:

- **2027 Juniors/Cadets**
- **2027 Seniors**
- **2025, 2026 and 2027 Veterans**

**Nathalie Rodriguez:** Before we move to a well-deserved coffee break, I would like to make a *Call for candidatures for the organisation of the next World Championships*.

I have to inform you that for the 2027 Junior and Cadet, we have already received a letter from the French Federation announcing their candidature. Also, still from the French Federation, the Veteran World Championships 2026. I would like to know if there are other candidates for these World Championships.

So, we have 2027 Junior and Cadet, 2027 Seniors, and 2025, 2026, 2027 Veterans.

I think also Tunisia is a candidate for the Veterans 2025. Can you confirm? Tunisia? Yes. 2025 Veterans World Championships. Yes, Estonia.

**Heino Märks (EST):** We would like to organise in 2027.

**Nathalie Rodriguez:** For the Juniors?

**Heino Märks (EST):** Seniors.

**Nathalie Rodriguez:** So, 2027 Seniors, Estonia. Yes.

**Gulnora Saidova (UZB):** Uzbekistan, 2026 Seniors.

**Nathalie Rodriguez:** Microphone, please, because I cannot hear you well.

**Gulnora Saidova (UZB):** Uzbekistan 2026 Senior World Championships. Seven, sorry, 2027.

**Nathalie Rodriguez:** Uzbekistan, 2027 Seniors.

**Sheikh Salem Al Qasimi (UAE):** 2027 Seniors.

**Nathalie Rodriguez:** Also. UAE also 2027 Seniors.

**Murat Atali (TÜR):** Türkiye is a candidate for the 2027 Cadets and Juniors.

**Nathalie Rodriguez:** Anyone for the 2027 Veterans? Yes.

**Roxana Barladeanu (ROU):** Romania would like to announce its candidacy for the Junior and Cadet World Championships 2027.

**Nathalie Rodriguez:** Very good. Anyone else? Thank you very much. After the Congress, we will send you the candidature forms so that you can fill them out and provide all the information.

Thank you very much. And now, a coffee break.

*Coffee Break.*

## 12. Proposals submitted to the Congress, reports of the Commissions, Councils, and Ethics Committee. Urgent decisions regarding the Rules.

**Nathalie Rodriguez:** Please take your seats; we are going to resume the meeting. We are moving to the next item of the agenda, which is *Proposals submitted to Congress, reports of the Commissions, Councils, and Ethics Committee, and urgent decisions regarding the Rules.*

**Nathalie Rodriguez:** We are starting with the modifications to the Statutes.

### Proposals for the amendment of the Statutes, with the opinion of the Commissions, Ethics Committee, and the Executive Committee

*Proposal #1* is from the Swedish Fencing Federation. The Legal Commission was not in favour and the Executive Committee was not in favour of the proposal. Yes.

**Ana Valero-Collantes (SWE):** Ladies and gentlemen, dear delegates,

Today, we gather to discuss an important step forward for our International Fencing Federation. It is an exciting moment where we blend our rich tradition with the possibilities of modern innovation.

I am honoured to speak to you about the importance of embracing change and why livestreaming should become a part of our journey.

Before we dive into this, let us remember that we are not alone in this adventure.

Many other international sports federations and organisations are already using livestreaming to connect with their global communities. For example, the International Olympic Committee shares major announcements through livestreaming. Some others live broadcast crucial meetings, including elections and other significant events.

So, why should we, the International Fencing Federation, also consider livestreaming?

First, it is about reaching out globally. Livestreaming helps us break down geographical barriers, making fencing accessible to anyone, no matter where they are. It is about transparency and trust. Livestreaming shows our commitment to being open about our decisions. When people can see and hear our discussions, it builds trust with our stakeholders.

Second, it is about the next generation. Livestreaming speaks the language of young people. It invites them to join our fencing family, inspiring new fencers, officials, and fans.

Third, it is about securing vital financial support. Livestreaming presents us with the opportunity to find new partners and sponsors, offering us the resources necessary to expand the reach of fencing on a global scale.

Fourth, it is about using data for better decisions. Livestreaming provides valuable data that helps us understand our viewers and improve our offerings.

Fifth, it is about inclusivity. Livestreaming allows everyone, no matter their situation, to be part of our events and discussions.

Sixth, it is about promoting fencing. Livestreaming lets us showcase our sport's inner workings, attracting new enthusiasts and athletes.

Innovation is not just an option; it is our responsibility to keep fencing relevant in the modern world. Let us seize this opportunity, not as followers, but as leaders who can make fencing shine even brighter on the global stage.

I ask you, dear delegates, to vote in favour of livestreaming during our congresses. Together, we will bring a new era of transparency, engagement, and global participation to the International Fencing Federation.

**Nathalie Rodriguez:** Thank you. Please remember that for the Statutes, you need two-thirds of the votes for the proposal to pass.

The vote is open.

The vote is closed.

The proposal did not pass.

*Proposal #2* is from the Legal Commission, which has revised its proposal. The Executive Committee was in favour of the revised proposal from the Legal Commission with some minor modifications for the sake of clarity.

So, we are voting on the revised proposal of the Legal Commission, which was also revised by the Executive Committee.

The vote is open.

The vote is closed.

The proposal passed.

*Proposal #3* is also from the Legal Commission. The Medical Commission was not in favour, but the Legal Commission revised its proposal, and then the Executive Committee considered the opinions of the Medical and Legal Commissions and made a revised proposal.

So, we vote on the final proposal of the Executive Committee. The vote is open.

The vote is closed.

The proposal passed.

*Proposal #4* is from the Legal Commission. The Legal Commission has revised its proposal, and the Executive Committee also revised it.

We are voting on the final proposal from the Executive Committee. The vote is open.

The vote is closed.

The proposal passed.

*Proposal #5* is also from the Legal Commission. The Promotion Commission has revised the text. The Legal

Commission has revised the text. And the Executive Committee has provided a final text, considering the opinion of the Promotion and Legal Commissions.

We vote on the proposed text from the Executive Committee. The vote is open.

The vote is closed.  
The proposal passed.

*Proposal #6* is from the Legal Commission. The Refereeing Commission was not in favour, so the Legal Commission revised its proposal, and the Executive Committee has provided a final proposal.

So, we are voting on the final proposal from the Executive Committee. The vote is open.

The vote is closed.  
The proposal passed.

*Proposal #7* is from the Legal Commission. The Rules Commission was not in favour, so the Legal Commission revised its proposal, and the Executive Committee proposed a new final text. So, we vote on the final proposal from the Executive Committee... Yes.

**Giuseppe Cafiero (ITA):** Cafiero, on behalf of the Italian Federation, I am also a member of the Rules Commission that has already given a non-favourable opinion on this point. I want to underline that in any government, in any normal country, the government and the ministries make the laws, and the judges and the technical people apply the rules. If we assign the judges as the only people qualified to prepare the laws they must apply, this is the wrong way of considering the matter. The two categories must remain independent. The present text gives the possibility to become members of the Commission only to referees and members of *Directoire Technique* in a limited quantity. This is against the spirit of the division of power. Thank you.

*Applause.*

**Kiyoshi Wada (JPN):** Madam CEO, the Japanese Federation. So, our Federation, in principle, is favourable to the proposal, except for the last point, which requested to be a member of this Commission for at least two mandates. And this part caused the rigidity of the composition of members. So, if we vote, I suggest you first vote if we include this part. Afterward, vote on this entire paragraph. Thank you so much.

**Nathalie Rodriguez:** So, if you have read the opinion of the Executive Committee, the Executive Committee agreed to the criteria introduced for the Rules and Promotion Commissions, but also included that if the persons do not meet the criteria, one of the other criteria can be – being a member of the Commission for at least two mandates. You have voted this for all the other Commissions: Legal, Promotion, and Refereeing, so there is no reason to make an exception for the Rules Commission.

**Kiyoshi Wada (JPN):** So it is correct. So, when we looked at these clauses, other parties had not raised the issue, and only our concerned member challenged this part. Thank you.

**Nathalie Rodriguez:** So, we are going to vote on the final proposal of the Executive Committee, and if it does not pass, then it does not pass.

The vote is open.  
The vote is closed.  
The proposal did not pass.

We move to *Proposal #8*, which is also a proposal from the Legal Commission. The SEMI Commission revised it; then, the Legal Commission revised its proposal. And the Executive Committee provided a final text for this Commission.

We open the vote on the proposal from the Executive Committee. The vote is open.

The vote is closed.  
The proposal passed.

*Proposal #9* is a proposal from the Executive Committee. The Legal Commission was in favour. The Athletes' Commission was in favour. And if the text is adopted, it will be implemented at the next elections of the Athletes Commission in 2025.

The vote is open.  
The vote is closed.  
The proposal passed.

*Proposal #10* is from the Legal Commission. The Executive Committee was in favour of the proposal.

So, we move to the vote on *Proposal #10*. The vote is open.

The vote is closed.  
The proposal passed.

*Proposal #11* was withdrawn, so we are moving to *Proposal #12*.

*Proposal #12*. This is a proposal from the Women and Fencing Council. The Legal Commission was in favour, and the Executive Committee was in favour.

We move to the vote, and the vote is open.

The vote is closed.  
The proposal passed.

The next proposal is *Proposal #13* from the Women and Fencing Council. The Legal Commission has revised the proposal, and the Executive Committee is in favour of the proposal as revised by the Legal Commission.

We move to the vote on the revised proposal from the Legal Commission. The vote is open.

The vote is closed.  
The proposal passed.

This was the last proposal regarding the Statutes. **We now move to the proposals regarding the Rules.** So, for the Rules, the simple majority applies.

## **Proposals for the amendment of the Rules, with the opinion of the Commissions, Councils, and the Executive Committee**

*Proposal #1* is a proposal from the Women and Fencing Council. The Rules Commission was not in favour, and the Executive Committee revised the proposal.

We vote on the revised proposal from the Executive Committee. The vote is open.

The vote is closed.  
The proposal passed.

*Proposal #2* is from the Rules Commission; the SEMI Commission was in favour, and the Executive Committee was in favour.

We move to the vote on *Proposal #2*. The vote is open.

The vote is closed.  
The proposal passed.

*Proposal #3* is a proposal from the Women and Fencing Council. The Veterans' Council was in favour. The Rules Commission was not in favour, saying that the Administrative Rules already cover it, but actually it is not. The Executive Committee is in favour of the proposal.

We move to the vote, and the vote is open.

The vote is closed.  
The proposal passed.

*Proposal #4* is from the Women and Fencing Council. The Rules Commission was in favour. The Medical Commission was in favour. The Refereeing Commission was not in favour. The SEMI Commission was in favour. The Veterans' Council was in favour. The Women and Fencing Council has revised its proposal, and the Executive Committee took into account all the revised texts and proposed a final text, which takes into account the specificity of the proposal.

We vote on the revised proposal from the Executive Committee. The vote is open.

The vote is closed.  
The proposal passed.

*Proposal #5* is from the Women and Fencing Council. The Refereeing Commission was not in favour. The Rules Commission was not in favour. The Executive Committee has proposed a revised text.

And we vote on the revised text from the Executive Committee. The vote is open.

The vote is closed.  
The proposal passed.

*Proposal #6* is from the Women and Fencing Council, and it has been withdrawn. Can you confirm? Yes, confirmed. So, it is cancelled, it is withdrawn, so we move to the next proposal, which is *Proposal #7*.

*Proposal #7* is from the Rules Commission. It is a very long proposal because it removes the current text of the Veterans World Championships in order to create a new Chapter and of course also provides updating of the Rules. So, it is very, very, very, very long. There were also some modifications made by the Refereeing Commission. The Executive Committee was in favour of the proposal with the modifications from the Refereeing Commission.

We move to the vote, and the vote is open.

**Someone in the audience:** Excuse me.

**Nathalie Rodriguez:** Sorry, yes? Can we please have a technician fix the microphone? It is working now.

**Giuseppe Cafiero (ITA):** Cafiero on behalf of the Italian Federation. I want to recall to this Assembly that a few years ago, the book of organisation was made like we are now proposing. Veterans were put at the end of the book in a separate chapter. The working group that was established a few years ago by the Commission and some other experts worked hard to revise the Book of Organisation and the Technical Book to make them consistent and give a logical way of examining the matter.

On this occasion, the Veterans were taken away from a separate chapter and integrated into the other categories. That is, at each step of the book, we mention and indicate the Rules for Seniors, Juniors, Cadets, and Veterans. I do not understand why, and I already expressed this in the Rules Commission, we should now take them out and put them apart in a separate chapter like a reduction of dignity and importance of this category. Exactly the contrary to what we have made when we have integrated them, giving them equal importance as to the other categories in the books.

Apart from the complication in terms of revising numbers, figures, and references, that this is a technical matter, strategically, we are not doing a favour to this category because we are showing that they are something else. That is exactly the opposite of the effort that we have made for many years to demonstrate that Veterans have equal importance, maybe not technical, but in terms of Rules to the other categories. Thank you.

**Nathalie Rodriguez:** Mr. Cafiero, I would like to highlight that the aim was not at all to put the chapters on the Veterans at the end of the book. This is not the case at all. The different Rules regarding Veterans were in different parts of the Organisation Book. The aim was actually to gather them and make some modifications, which were also requested by the Veterans Council. So, I would like to give the floor to the President of the Rules Commission.

**Giuseppe Cafiero (ITA):** Just to be precise, why are we not doing the same for all the other categories, collecting all the Rules for each category in a separate chapter as it was in the past that we considered not rational?

**Nathalie Rodriguez:** Mr. Cafiero, you are a member of the Rules Commission. So, please ask the Rules Commission about this.

**Ziad Feriani (TUN):** Thank you very much, Nathalie. I would like to remind Mr. Cafiero that he is a member of the Rules Commission. And he participated actively in this modification. And he was also there, when we voted, he agreed to this change. As well as... I wrote everything, Mr. Cafiero. We recorded everything regarding the



votes. It was also at the request of the Veterans Council. We preferred to put a separate chapter also to give them the chance to have their separate and very clear Rules. But I also ask others that this type of discussion takes place inside the Commission. When we have voted in a Commission, there is no longer any point in coming back to Congress and disrespecting all that. Thank you very much.

**Nathalie Rodriguez:** I would like to remind you that the Veterans Council is in favour of that proposal and to gather all the elements in a chapter. Yes. Please.

**Someone in the audience:** I need a new device, please.

**Nathalie Rodriguez:** Ah, yes, but please go there. Thank you. We are opening the vote on that proposal with a slight modification from the Refereeing Commission.

The vote is open.

The vote is closed.

The proposal passed.

*Proposal #8* is from the Rules Commission, and the Executive Committee was in favour of the proposal.

So, we move to the vote. The vote is open.

The vote is closed.

The proposal passed.

*Proposal #9* is from the Rules Commission. The Executive Committee is in favour, and if the proposal passes, the corresponding text in the Administrative Rules will be removed in order to avoid duplication of texts.

We move to the vote, and the vote is open.

The vote is closed.

The proposal passed.

*Proposal #10* is from the Veterans Council. The Rules Commission was in favour of the proposal but not with item 2.b). The Executive Committee is in favour of the proposal, but without item 2.b), as it would duplicate the number of delegates from the Veterans Council at the World Championships.

So, we are going to vote on the proposal without item 2.b). And the vote is open.

The vote is closed.

The proposal passed.

*Proposal #11* is from the Rules Commission. The Refereeing Commission was in favour, and the Executive Committee was in favour.

We move to the vote and the vote is open.

The vote is closed.

The proposal passed.

*Proposal #12* is from the Rules Commission, and the Executive Committee was in favour of the proposal.

We move to the vote.  
The vote is closed.  
The proposal passed.

*Proposal #13* is from the Rules Commission, which was revised by the Rules Commission, the Refereeing Commission, and the SEMI Commission. The Executive Committee was in favour of the proposal of "four or eight pistes" in the summary table.

So, we vote on the revised final text from the Executive Committee.

The vote is open.  
The vote is closed.  
The proposal passed.

*Proposal #14* is from the Rules Commission. The Executive Committee was in favour of the proposal. Actually, it is not truly a modification but more an explanation.

We open the vote on *Proposal #14*, and the vote is open.

The vote is closed.  
The proposal passed.

*Proposal #15* is from the Rules Commission. The Executive Committee was in favour.

So, we move to the vote, and the vote is open.

The vote is closed.  
The proposal passed.

*Proposal #16*. The Executive Committee is in favour of the proposal but starting from the season 2024-2025 so as not to impact the Olympic qualification, which is currently taking place.

We move to the vote, and the vote is open.

Please vote because I could see from the last votes that some Federations do not vote. And please follow the process. I know it is tiring. I know this is after lunch, but we need you to vote.

*Laughter in the audience.*

The vote is closed.

**Nathalie Rodriguez:** The number of votes is improving.

*Laughter in the audience.*

**Nathalie Rodriguez:** But we can still improve.

*Laughter in the audience*

So, *Proposal #16* passed.

We move to *Proposal #17*, which is also a very long proposal because it is an updated Table of Contents, and also a revised Index. The Executive Committee was in favour, and the Rules Commission made one correction on the numbering, part E for the Veterans.

So, we move to the vote, and the vote is open.

The vote is closed.

The proposal passed.

We are decreasing the number of votes, so we should improve.

The proposal passed.

The following proposal is *Proposal #18*, and this is an updated Index of the Organisation Rules. It is also a long proposal. The Executive Committee was in favour.

So, we move to vote on this proposal, and the voting is open.

The vote is closed.

The proposal passed.

There are around 15 Federations that do not vote. This is bad.

*Proposal #19* was removed by the Rules Commission.

*Proposal #20* is from the SEMI Commission. The Rules Commission was in favour, and the Executive Committee was in favour.

So, we move to the vote. The vote is open.

The vote is closed.

The proposal passed.

*Proposal #21* is from the Rules Commission. The proposal is very long. The Refereeing Commission was not in favour of additional texts and proposed some revisions. The Executive Committee was in favour of the proposal from the Rules Commission.

So, we vote on the proposal from the Rules Commission with slight modifications from the Refereeing Commission.

And we open the vote. The vote is open.

The vote is closed.

The proposal passed.

*Proposal #22* is from the Rules Commission. The Refereeing Commission is not in favour because it thinks that everything is already clear in the Rules. The Executive Committee is in favour of the proposal.

So, we move to the vote. The vote is open.

The vote is closed.  
The proposal passed.

*Proposal #23* is from the Rules Commission. The Refereeing Commission was in favour, the Rules Commission made a new correction, and the Executive Committee was in favour of the proposal as revised by the Rules Commission.

So, we move to the vote. The vote is open.

The vote is closed.  
The proposal passed.

*Proposal #24* is from the Rules Commission. The Medical Commission did not agree with the proposal. The Athletes' Commission disagreed with the proposal. The Executive Committee agrees with the Medical Commission's comments on health risk and is not in favour of the proposal. Yes.

**Jeremy Summers (USA):** Jeremy Summers, President of the Medical Commission. We would just like to say that for the Medical Commission, we unanimously opposed the Rules Commission's proposal to reduce the medical timeout from five minutes to three minutes for a trial at the Junior World Championships in 2024. Our stance is underscored by the lack of or limited and inconclusive data and the absence of data available at the FIE events, altering any Rule change in the Medical Commission for FIE events. We look forward to a joint proposal for the Rules Commission to collect that available data.

**Nathalie Rodriguez:** So, we move to the vote on this proposal. The vote is open.

The vote is closed.  
The proposal did not pass.

*Proposal #25* is from the Refereeing Commission. The Rules Commission was in favour, and the Executive Committee was in favour.

So, we move to the vote. The vote is open.

The vote is closed.  
The proposal passed.

*Proposal #26* is from the Refereeing Commission. The Rules Commission was in favour, and the Executive Committee was in favour.

We move to the vote, and the vote is open.

The vote is closed.  
The proposal passed.

*Proposal #27* is from the Rules Commission. The Refereeing Commission said that it is not in favour because the Organisation Rules are clear. The Rules Commission was in favour, but with a new correction. And the Executive Committee is in favour of the proposal as revised by the Rules Commission.

We move to the vote, and we open the vote. The vote is open.

The vote is closed.  
The proposal passed.

*Proposal #28* is from the Fencing Federation of Jamaica. The Refereeing Commission was not in favour. The Coaches' Council was not in favour. The SEMI Commission was not in favour. The Athletes Commission agreed in theory, but it would like the language to be changed and the proposal to be specified. The Rules Commission was not in favour, and the Executive Committee was not in favour.

So, we move to the vote. The vote is open.

The vote is closed.  
The proposal did not pass.

*Proposal #29* is from the Rules Commission. The Refereeing Commission made a revised proposal. The SEMI Commission was in favour. The Rules Commission was in favour of a new correction. The Executive Committee was in favour of the proposal as revised by the Rules Commission.

So, we move to the vote. The vote is open.

The vote is closed.  
The proposal passed.

*Proposal #30* is from the Rules Commission. The Refereeing Commission was in favour. The SEMI Commission was in favour, and the Executive Committee was in favour. Regarding the SEMI Commission's request, it should be considered as a future proposal to be dealt with by the Rules Commission.

So, we move to the vote. The vote is open.

The vote is closed.  
The proposal passed.

*Proposal #31* is from the Refereeing Commission. The Executive Committee would like to postpone this proposal in order to establish a working group to work on this proposal. The President of the Refereeing Commission agreed to establish a working group in order to present a final proposal after the working group's review. So, we will not vote on this proposal because it has been postponed. And we will establish a working group with the Refereeing Commission and the Rules Commission.

*Proposal #32* is from the Refereeing Commission. The Rules Commission was in favour, and the Executive Committee was in favour.

So, we move to the vote. The vote is open.  
The vote is closed.  
The proposal passed.

*Proposal #33* is from the Women and Fencing Council. There were many opinions on this. In the end, the Executive Committee came up with a revised text for this proposal, but generally agreed on the proposal and made a revision on the last sentence of the paragraph.

So, we move to the vote on this proposal with a revised paragraph from the Executive Committee.

The vote is open.  
The vote is closed.  
The proposal passed.

*Proposal #34* is from the Women and Fencing Council. So, there were many opinions. In the end, the Executive Committee was in favour of the proposal, but with an amended paragraph.

So, we move to the vote on the proposal as revised by the Executive Committee. And we open the vote. The vote is open.

The vote is closed.  
The proposal passed.

*Proposal #35* is from the Rules Commission. The Refereeing and Athletes Commissions and the Coaches' Council were in favour, and the Executive Committee was in favour.

We move to the vote. The vote is open.  
The vote is closed.  
The proposal passed.

*Proposal #36* is from the Refereeing Commission. The Rules Commission was in favour, and the Executive Committee was in favour.

So, we move to the vote, and the vote is open.  
The vote is closed.  
The proposal passed.

But we are decreasing the number of votes again and again. Please! Wake up!

*Laughter in the audience*

So, the proposal passed, but please, please.

*Laughter in the audience*

*Proposal #37* is from the Rules Commission. The proposal was revised by the Refereeing Commission and then the Rules Commission. The Executive Committee was in favour of the proposal as revised by the Rules Commission.

So, we move to the vote on the proposal as revised by the Rules Commission.

The vote is open.

The vote is closed.

The proposal passed.

*Proposal #38.* The Refereeing Commission was not in favour, but the Rules Commission made a modification, and the Executive Committee was in favour of the proposal as revised by the Rules Commission.

So, we move to the vote, and the vote is open.

After this proposal, only ten will remain. I tell you this to give you some courage.

*Applause.*

The vote is closed.

The proposal passed.

*Proposal #39* is from the Rules Commission. The Executive Committee was in favour of the proposal.

We open the vote on this proposal. The vote is open.

The vote is closed.

The proposal passed.

*Proposal #40* from the Rules Commission was discussed with the Refereeing Commission, which made modifications. Then, the Rules Commission reviewed the proposal and made other modifications, and the Executive Committee summarized the revisions from the Rules and Refereeing Commissions and proposed a final text.

So, we vote on the final text proposed by the Executive Committee.

We open the vote. The vote is open.

The vote is closed.

The proposal passed.

*Proposal #41* is from the Refereeing Commission. The Rules Commission was in favour. The Executive Committee was in favour and made a modification to articles t.124.1 and t.124.2 in the Column of Articles.

So, we move to the vote, and the vote is open.

The vote is closed.

The proposal passed.

*Proposal #42* is from the Rules Commission. The Refereeing Commission made some comments and proposed some revisions. The Rules Commission made a modification. The Executive Committee was in favour of the revised proposal.

So, we vote on the proposal as revised by the Executive Committee. And we open the vote. The vote is open.

The vote is closed.

The proposal passed.

*Proposal #43* is from the Rules Commission. The Executive Committee was in favour of the proposal and just added the colour of the card to the table.

So, we move to the vote, and the vote is open. The vote is closed. The proposal passed.

*Proposal #44* is from the Rules Commission. It is the revised Index of the Technical Rules. The Executive Committee was in favour of the proposal.

We move to the vote, and the vote is open. Only five proposals remain.

The vote is closed.

The proposal passed.

*Proposal #45* is from the SEMI Commission. The Promotion, Athletes, and Rules Commissions were in favour with some modifications. The Executive Committee revised the proposal, and we vote on the proposal as revised by the Executive Committee.

We open the vote, and the vote is open.

The vote is closed.

The proposal passed.

*Proposal #46* is from the Refereeing Commission. The SEMI and Rules Commissions were in favour, and the Executive Committee was in favour.

We move to the vote, and we open the vote. The vote is open.

The vote is closed.

The proposal passed.

*Proposal #47* is from the SEMI Commission. The Rules Commission was in favour of the proposal to remove the text in the Material books. The Executive Committee agreed with the SEMI and Rules Commissions, and the rule on chipping must be cancelled until a viable solution is found and submitted to Congress.

So, we move to the vote on this proposal. The vote is open.

The vote is closed.

The proposal passed.

*Proposal #48* is from the SEMI Commission. The Rules Commission was in favour, and the Executive Committee was in favour.

So, we move to the vote, and the vote is open.

The vote is closed.

The proposal passed.

*Proposal #49* is the last proposal. This proposal has already been communicated to you as an urgent decision by Information Letter 3-23 and it was already implemented after the Junior and Cadet World Championships 2023. The Executive Committee was in favour.



So, we open the vote on this proposal, which was communicated to you as an urgent decision.

The vote is open.

The vote is closed.

The proposal passed.

We now move to **Urgent Decisions**.

### **Urgent Decisions regarding the Rules**

*Urgent Decision #1* was the last proposal that we have already voted on from the SEMI Commission. So, this has already been voted for.

*Urgent Decision #2* was an urgent decision from the Executive Committee regarding articles t.1 and t.122. These decisions were communicated to the Federations in September, and the Executive Committee proposed making them valid until the end of this current season, which is 2023-2024.

So, we move to the vote on these urgent decisions from the Executive Committee.

The vote is open.

The vote is closed.

The urgent decisions passed.

We have finished with the *Proposals and the Urgent Decisions regarding the Rules*.

## 13. Progress reports from the working groups

**Nathalie Rodriguez:** We now move to the *Progress reports from the working groups*.

You received the report from the *Environment Group*, which has done a very good job, and some of the proposals are already in place and successful.

You have also received the report regarding the Olympic qualification. The working group on *the Olympic qualification* could not find a solution for improving the current system. So, the proposal will be to renew, to have a new working group in order to try to find solutions to improve the qualification system. After this Congress, I would like the Federations who are interested in being part of that new group, to send us an email so that we can, as soon as possible, finalize the group and start the work.

Yes, Mr. Drakenberg.

**Otto Drakenberg (SWE):** Can you hear me? Yes. Thank you very much. I would not say for once, but I am very happy that you have come to that conclusion with the working group. The Swedish Federation has been bringing up the matter of Olympic qualification criteria and that they are not fair or fair enough for several years now. And, of course, we are disappointed that during the two years that have passed since the working group was established in Lausanne no progress has been made. There is still time then, of course, to find and establish new fairer qualification criteria for the 2028 Games in Los Angeles. However, we must work with speed to achieve that.

For us, in the European Fencing Confederation (EFC) that had a meeting yesterday, I understood that there was also a decision being taken during that meeting that the EFC would work actively now to come up with proposals in line with the needs that we see and bring them forward in just time to the FIE to work as productively and cooperatively as possible to make progress in this very important area.

Lastly, this is a matter of greatest importance for the longevity of fencing as an Olympic sport. I am convinced that this is one of the things that will secure fencing as part of the Olympic family in the future, making sure that all the best fencers in the world have a fair chance to participate. So, thank you for your proposal to continue the work. EFC is very committed to participate and contribute. Thank you.

*Applause.*

## 14. Proposals from the Ukrainian Fencing Federation

**Nathalie Rodriguez:** The next item is item #14, the *Proposals from the Ukrainian Fencing Federation*. Yes, please.

**Mikhail Ilyashev (UKR):** Mikhail Ilyashev, President of the Ukrainian Fencing Federation.

Dear Ladies and Gentlemen,

Thank you for giving me the floor to speak on behalf of the Ukrainian Fencing Federation regarding the proposal we submitted to the head office on the 24th of March 2023, for voting at this Congress.

Putting at stake at the beginning of this year, the suspension of membership of Russian and Belarusian Fencing Federations remains urgent today. To our deepest regret, the war waged by Russia against Ukraine and supported by Belarus has not come to an end. In a blatant disregard for the fundamental principles of international law, Russia, in alliance with Belarus, violated the territorial integrity of Ukraine and occupied the Autonomous Republic of Ukraine in 2014, supported and eventually incorporated the so-called Lugansk and Donetsk People's Republics in 2022 and broke out a full-scale war against Ukrainian territory on 24th of February 2022.

Pursuant to the orders and instructions of the Russian government, the Russian Fencing Federation illegally incorporated the so-called Regional Fencing Federations established on the annexed territories of Ukraine and now proudly demonstrates them on its website. Those are the Fencing Federation of the Lugansk People's Republic, the Fencing Federation of Donetsk People's Republic, the Fencing Federation of the Republic of Crimea, and the Sevastopol Fencing Federation.

This stands in sharp contrast with what the President of the Russian Fencing Federation said to the fencing community during the extraordinary online Congress on March 10th of this year. I now quote Mr. Mamedov: "We are not working for the government. We are only athletes." If that had been the truth, how does it come in line with the fact that the Russian Fencing Federation gladly and unquestionably executed the orders of the Russian Ministry of Sports and annexed the Regional Fencing Federations operating on the territory of another sovereign state? Mr. Mamedov's words are nothing more than the echo of constant lies and misrepresentations of the Russian government, which Belarus openly supports.

To be noted, the alliance of Russian and Belarusian governments fosters the same close relations between the Russian and Belarusian Fencing Federations. Belarusian fencers gladly participate in the all-Russian Fencing Championship, and the Russian Fencing Federation today represents Belarusian Fencing Federation in Congress. The conduct of both the Russian and Belarusian Fencing Federations certainly lifts the curtains of their non-governmental nature and once again proves that these two Fencing Federations are just structural units of their governments, support the brutal policy against Ukraine, and therefore shall bear international responsibility.

A brilliant example, which, in my opinion, shall be followed by all international sports organisations, including the FIE, was demonstrated on the 24th of June this year when the Congress of the European Fencing Confederation decided, among other things, to suspend the membership of Russian and Belarusian Fencing Federations on the grounds of Russia's and Belarus's instigation of the war against Ukraine and the Russian Fencing Federation settling of Regional Fencing Organisation, as I have mentioned before, on the territories of Ukraine. This was a big victory for the Ukrainian Fencing Federation and for all the Ukrainian fencing community. The intrusion of the Russian Fencing Federation into the internal relations of Ukraine is a vivid demonstration that Russian sport

backs politics and is far into it.

Ukraine is a sovereign state with internationally recognized borders and sovereign territory which are inviolable. By incorporating Donetsk, Lugansk, Sevastopol, and Crimean Regional Fencing Federations in its structure, the Russian Fencing Federation de facto represents fencing in two independent states: Ukraine and Russia. Such a status violates the Statutes of the International Fencing Federation. It contradicts the principle of one country, one fencing authority, according to which membership is granted exclusively to the National Federation, which is the only representative of fencing in its country.

The Ukrainian Fencing Federation submits that this is not only unlawful, but it also demonstrates a dangerous precedent for the international sports community. We need to follow the position of the International Olympic Committee, which suspended the Russian Olympic Committee from the Olympic movement for violation of the territorial integrity of the National Olympic Committee of Ukraine. The International Olympic Committee made it clear that it would not tolerate vivid breaches of the Olympic Charter by the Russian Olympic Committee, which incorporated into its structure sports organisations located in integral territory of Ukraine. The IOC decision shall serve as an example of a devoted democratic position and direction for the International Fencing Federation as well.

To conclude what was already being said, the actions of the Russian and Belarusian Fencing Federations shall be treated as a series of extremely severe offenses in the meaning of the Statutes of the International Fencing Federation, showing utmost arrogance and a sense of impunity of these National Federations. The time has come for the International Fencing Federation to demonstrate its democratic position and put an end to this blatant infringement of its Statutes. The Ukrainian Fencing Federation strongly encourages all the member Federations to stay united for peace and integrity of the fencing family and vote in favour of the proposal to suspend membership of the Russian and Belarusian Fencing Federations from the International Fencing Federation. Thank you for your attention.

*Applause.*

**Emmanuel Katsiadakis (MH):** Thank you, Mr. President.

When the Executive Committee of the IOC decided to suspend the Olympic Committee of the Russian Federation, the FIE sent a letter to the IOC about the situation with the National Federations and what is necessary to do about it. Because in the past some decisions were already made there. For instance, if it suspended one National Olympic Committee, the IOC could also give an instruction not to permit athletes to participate under the flags of this Olympic Committee.

In this situation with the Russian exclusion from the IOC, we sent a letter to ask what was the opinion of the IOC about the fencers, the officials, and, of course, the Federation. So, we received an answer from the Sports Director of the IOC, of course, under the discussion with the members of the Executive Board. The IOC Executive Board's decision is purely based on the action of the Russian Olympic Committee. It does not imply that the FIE should automatically and systematically take similar measures vis-a-vis their respective National Federation for the sole reason that the IOC has suspended it. The NOC received this decision, but it was not required to have the same decision in the National Federation for the athletes of the Federations. It is up to each International Federation on a case-by-case basis to examine the situation of the respective National Federations in view of the IF Statutes and if there is any violation of the International Federation Statutes to take any action they deem appropriate in accordance with the IF Statutes.

We think, with this proposition from the IOC, it depends on the decision of the International Federation, and especially it is the same in our International Federation. So, we have discussed this issue in the Executive Committee, and the Executive Committee proposes to the Congress not to suspend the Russian and Belarusian Federations.

Of course, there are two different cases because, in the case of the Russian Federation, the decision should be taken with a simple majority. But for the Belarusian Federation, we need three-fourths of the votes. And concerning the athletes, the decision is to propose to the Congress that the athletes and the officials, under the recommendations of the IOC, should not be suspended but follow the IOC recommendations. This is the proposition of the Executive Committee, and we put this to your decision. We must do it in three votes. As I said before, the voting for the Russian Federation is with a simple majority. For the Belarusian Federation, we need three quarters, and for the athletes and officials it is a simple majority.

**Velichka Hristeva (BUL):** Can you please read the decision of the Executive Committee?

**Nathalie Rodriguez:** The Executive Committee yesterday made a recommendation as the Executive Committee and the FIE always followed the IOC recommendations. Based on the letter that we received from the IOC Sports Director, and based on past decisions, in particular decisions from the Extraordinary Online Congress, the recommendation of the Executive Committee to the Congress is that the Executive Committee is not in favour of the suspension of the National Federations of Russia and Belarus and is not in favour of the non-participation of athletes from Russia and Belarus. In other words, the recommendations and the opinion of the Executive Committee are not in favour of the proposals from the Ukrainian Fencing Federation. But it is up to Congress to take these decisions.

So, there are two proposals on the table from the Ukrainian Federation.

The first one is to suspend the Federations of Russia and Belarus. We asked for the opinion of the Legal Commission on what the majority should be to vote on these proposals. The Legal Commission said that for the Russian Federation, this is a simple majority. For the suspension of the Belarusian Federation, the majority is 3/4<sup>th</sup>. So, there should be two votes: one on the Federation of Russia and the second one on the Federation of Belarus.

And then, regarding the second proposal from the Ukrainian Federation on the non-participation of athletes from Russia and Belarus, it is one proposal, and the vote is made with a simple majority. So, in total, there will be three votes:

- On the suspension of the Federation of Russia,
- On the suspension of the Federation of Belarus,
- On the non-participation of the fencers and officials from Russia and Belarus.

Three proposals and three votes.

Who would like to speak on this proposal, Mr. Drakenberg, I think. So, Sweden. I would like to take the list of all those who wish to talk. So, there is Sweden; there is Canada. Who else?

**Ana Irene Delgado Guerra (PAN):** Barbados.

**Nathalie Rodriguez:** So, Barbados.

**Ana Irene Delgado Guerra (PAN):** Venezuela.

**Nathalie Rodriguez:** Venezuela.

**Ana Irene Delgado Guerra (PAN):** Armenia.

**Nathalie Rodriguez:** Armenia, Russia. Any other Federation? No?

**Ben Dauda Nass (GUI):** Guinea.

**Nathalie Rodriguez:** Guatemala? No, it is Guinea.

**Ana Irene Delgado Guerra (PAN):** One more there. Pakistan.

**Nathalie Rodriguez:** Pakistan. Any other Federation?

**Ana Irene Delgado Guerra (PAN):** There, in the back, sorry, in the back, USA. Uruguay.

**Nathalie Rodriguez:** Uruguay. Any other Federation would like to take the floor, nobody else? Okay, so we will start. Yes. Sorry, can you show me the card? Is it Pakistan or Paraguay? Paraguay. Ah. So, we are closing the list now. Any other Federation would like to talk? Fine. So, we start with Sweden.

**Otto Drakenberg (SWE):** Thank you. Mr. President, Dear Fencing Participants, A number of months have passed since we had the Extraordinary Congress in March of this year. But during this period, as much as the period between the war broke out and the Extraordinary Congress in March of this year, there has been no structural change in the situation regarding the Russian aggression in Ukraine. Only more lives were shed on each side. By allowing Russian and Belarusian officials and fencers to participate in international tournaments, albeit under a neutral flag, we de facto give legitimacy to the Russian war effort, and we contribute to normalizing the aggression.

Therefore, we in the Swedish Federation insist that the FIE exclusion regime set in 2022 should be reinstated, both for Russian and Belarusian athletes and officials. It is the only way forward. Thank you.

*Applause.*

**Nathalie Rodriguez:** Canada.

**Yann Bernard (CAN):** Thank you. This is simply a matter of information; many people wonder why two different majorities are required for the two resolutions.

**Nathalie Rodriguez:** As I said, we consulted the FIE Legal Commission, which said that as the IOC suspended the NOC of Russia, and this suspension is actually in the FIE Statutes, it can be voted on by a simple majority. However, regarding Belarus, the NOC of Belarus has not been suspended by the IOC, and therefore, for that proposal to pass, it would require a 3/4th of the vote. Maybe someone from the Legal Commission would like to confirm this question. Peter Jacobs, can you confirm that the Legal Commission has said that the suspension of the Russian Federation requires a simple majority, the suspension of the Belarusian Federation the three fourths and the vote on the participation of Russian and Belarusian fencers requires a simple majority?

**Peter Jacobs (MH, GBR):** Yes. Right. There are two conditions under which three-quarters of the majority is needed. One is if an item is not on the agenda. And the other is, and I need to remind myself, not provided for in the Statutes.

In the case of Russia, the justifications for suspending a Federation in the Statutes are covered because it is stated that if the IOC takes this action against a National Olympic Committee, the International Federation may take a comparable action against its National Federation.

In the case of Belarus, the IOC has not suspended the National Olympic Committee, and therefore, this condition is not met. And therefore, Marco Rioja and I, who studied this subject -it did not go to the whole Commission because there was no time – but we have been asked on several occasions to give advice, when it is needed urgently, to the FIE. And we concluded that because in the case of Belarus, the IOC had not suspended the Belarus National Olympic Committee, the simple vote in the FIE was not sufficient, following our Statutes. Thank you.

**Nathalie Rodriguez:** Thank you. We move to the next Federation, Barbados.

**Ralph York (BAR):** Hi, good afternoon. The area of clarification I was looking for was perhaps one element that was brought up in the Ukrainian President's presentation, which was the setting up of a free breakaway of three Federations in those established regions, which are currently under the control of Russia but were previously under the control of Ukraine, including Crimea and Donetsk. Was that raised as a point during the special Congress online in March? Or is that fresh information?

**Nathalie Rodriguez:** The proposals from Ukraine reached the FIE after the Extraordinary Congress of March. Venezuela.

**Francisco Rafael Marín Alvarez (VEN):** Good afternoon. Greetings, federation friends. I hope you are listening to the interpreting colleagues who say that the voice does not reach them, and it is difficult to translate. Yes? No? That is why I mention it because... some do not make it to the translation. Well. Especially the call, again, for everyone. There is none?

**People in the audience:** No, no.

**Francisco Rafael Marín Alvarez (VEN):** That is why...

**Someone at the Tribune:** Channel 2.

**Nathalie Rodriguez:** Do you have a translation now?

**Francisco Rafael Marín Alvarez (VEN):** Yes.

**Nathalie Rodriguez:** Yes, okay. Fine. Okay. Venezuela.

**Francisco Rafael Marín Alvarez (VEN):** Thank you, friends interpreters.

Venezuela raises its voice again to call for the points we discuss here to be related to sports. We are not the International Criminal Court. If we are going to talk about war conflicts, we are near an area where there is a great conflict, and no one names it because that is not what we came for. Do we want to talk about politics? Let

us talk about the Olympic Charter. Let us talk about what the Olympic values carry. They have recently called us for an Olympic truce within the framework of the Paris Olympic Games. The Executive Committee, through the FIE, has been respecting what the IOC mandates regarding athletes from Belarus and Russia competing under a situation of neutrality.

Every time there is a Congress, we cannot come here to question the effort that all the athletes are making. Of course, solidarity with the athletes of Ukraine. Of course, solidarity with the athletes of Russia. But Venezuela, I repeat, I did not come to talk about myself, but we also live in discrimination; they deny us visas. Recently, there was a case in a soccer match; you can see it, and we do not come here to ask for suspensions of Federations or suspensions of athletes.

So, what does the Olympic Charter command us? It commands us to preserve peace, work for peace, and for unity through sport. We want to change the world. It is not suspending Federations; it is not suspending athletes. Yes, there are serious armed conflicts. I repeat, we are close to one, and no one names it. How many conflicts are there in Africa right now, on my continent right now? But no one names them. Let us talk about sports. Let us talk about fencing. I do not share some of the comments that some colleagues have made, calling the participation of athletes irresponsible or calling the International Federation irresponsible, because athletes compete; athletes are not irresponsible. No athlete supports any war intervention. Athletes want to compete; they want to win. We are now here near the Olympic Games.

Please, let us talk about fencing. We want to make peace. Let us build it from here. Let us work on unity and those who call for international laws. With this, I close. I remind once more, the UNESCO Charter, since so many international organisations name it, the UNESCO Charter for Physical Education requires us to promote peace through sport. Let us stop using sport as a tool for political pressure. We are going to use sport as a tool of peace and unity. And Venezuela will always support peace and will always support equality, non-discrimination, and the participation of all athletes and Federations that comply with the rules. Thank you.

*Applause.*

**Nathalie Rodriguez:** Armenia.

**Armen Grigoryan (ARM):** Dear Mr. President, Dear Colleagues, I would like to talk about a fellow sportsman, my sportsman from Armenia. He is from the Wrestling Federation. He is an Olympic Champion. He is World Champion. Last month, during an IOC meeting, he spoke about sports activity. He said that sports activities should be without politics. I agree with him 100 percent. I agree with him. We all gathered here, we are coming here to speak about our matters, to speak for fencing matters, not for politics. The Olympic movement is out of politics.

Dear Colleagues, I think today we must speak about our problems. Thank you so much for your attention. Thank you.

*Applause.*

**Nathalie Rodriguez:** Russia.

**Ilgar Mamedov (RUS):** Dear Delegates of Congress, Dear Interim President, Dear Colleagues. First of all, I would like to say a big thank you to the majority of delegations that voted during the Extraordinary Online Congress, which was held on March 10th. Your decision made it possible for our athletes to return to the international arena. I am very grateful to you for this support. Unfortunately, the IOC recommendations did not



allow the strongest athletes to return to competitions.

I am also grateful to the FIE Executive Committee for its hard work in bringing back athletes and specialists under neutral status. I understand it was not easy. It was not easy, and it is not easy right now because you see the situation. The IOC officially recognized the International Council of Military Sport in 1991. Our strongest athletes are in CSKA and Dynamo. This system is not only in Russia. If you want to participate in the Military Games, it is like the Olympic Games for military athletes, once every four years, or you want to participate in the World Military Championships, athletes and specialists must have military ranks. This is obligatory. The same system is not only in Russia, but it is the same system in Italy, Korea, China, Poland, Ukraine, everywhere. My colleague from China and I participated in the first military games in Roma in 1995. Yes, we were military, but not military personnel. We were military athletes. Everybody knows about this.

Sooner or later, this situation will be finished. I urge those Federations that vote against us not to take the wrong steps. Otherwise, when the situation ends, you will hide your eyes. As far as I know, Ukrainian athletes participate in almost all competitions with a big number of sportsmen, which they never had before. Never, ever. The FIE supports this project. It would be right to help athletes from Iraq, Syria, Libya, and other countries who have suffered and are suffering from military conflicts if you support Ukrainian sportsmen. Inshallah, it happens. In my life, as an athlete, I have had four Olympic Games. And it was a good time when if you wanted to be in the Olympic Games, you had to be on your national team, have qualification points in your country, and go to the Olympic Games. It was in Seoul in 1988, and it was in Barcelona in 1992. Unfortunately, after the Barcelona Olympic Games, the criteria in fencing were changed.

Unfortunately, the fencing family is divided between Federations, which work for the sport, and Federations, which work for politics. This coalition could use its efforts for something useful. This part of the Federations really likes to write letters to the FIE and the IOC. Send your efforts not to divide the FIE family but to restore a fair system for all National Federations when everyone participates in the Olympic Games, not only strong fencing countries but also those countries where fencing is developing. But these are most likely dreams since it is easier destroying everything than creating something.

In conclusion, I would like to say. Today, we watched a video with our good friends who passed away last year and this year. It was very sad. Let us do something good for our sport so that you are remembered for your good deeds.

Thank you for your attention.

*Applause.*

**Nathalie Rodriguez:** Guinea. No?

**Someone at the Tribune:** No, no.

**Nathalie Rodriguez:** Pakistan.

**Salman Choudhry (PAK):** In the name of God, the Most Gracious, the Most Merciful.

Thank you, Chair.

Ladies and Gentlemen, on behalf of the Pakistan Federation, let me say. We abhor all kinds of violence and

acts of aggression anywhere in the world, but sport represents the human spirit. It is the epitome of human excellence and valour. It defines who we are. It transcends the boundaries of race, ethnicity, colour, creed, and even religion. As the Chair mentioned in his speech earlier in the morning, as we were listening to him, he broke down when he said these words: let us not bring politics, let us not bring other vested interests into this body, onto this floor. We are over here to make the statement that we, as human beings, represent the best part, which is through sports. After all, the Olympics have a very long history, and they have defined what civilisation is.

The third most crucial part is the application of law. While listening to the legal points, you cannot have the application of the law to two different things at the same time, with three-fourths of the majority required to oust one country and a simple majority required to oust another country. I do not think it will give the legal semblance of the right decision based on the legal principles of this forum. So, I would urge you not to get involved in these politics and let them compete under their own national flag. This is a non-governmental organisation. It does not have anything to do with governments. Thank you very much.

*Applause.*

**Nathalie Rodriguez:** Uruguay.

**Diamante Peirano (URU):** Ladies and Gentlemen, good afternoon.

I am the President of the Uruguayan Fencing Federation. This is the oldest Federation in South America. We have been around for more than 100 years. I would appreciate the interpreters continuing now because I will switch to Spanish.

As I said, the Uruguayan Fencing Federation is the oldest Federation in South America. A Federation that is more than 100 years old. Personally, I think that the International Fencing Federation, in its decisions to date, has fully complied with what the Olympic Charter establishes.

I know the devastating effects of wars because I have seen them, and I have seen them on more than one continent. But personally, I believe that if we agree to what they are trying to achieve today, we will be making several serious mistakes. We would be crossing lines that would not allow us the possibility of turning back. We would be unfair to more than twenty-five, with those who are integrating today, to more than twenty-five war conflicts that the world has. In other words, we would have to place more than fifty countries in the international context. Furthermore, we would be unfair to those athletes from countries that do not have the possibility of requesting what is being requested in this Congress.

I consider the International Fencing Federation, made up of all the National Federations, to be a great machine intended to promote sport and the development of athletes. Unfortunately, in this machine, there are some parts that are failing for different reasons that I understand are not worth analysing because they are extremely painful. However, I believe that we must work to promote freedom for our athletes so that they can practice the sport of fencing and so that all our athletes can practice sports in an environment of equality. And from that, we can achieve brotherhood among our athletes, and what the athletes teach us, or partly teach the politicians, is how to function in a better way. I believe that every time we raise these issues in Congress, and politics are mixed with the objectives of sport, the only thing we do is harm our sport and waste time. That is all. Thank you so much.

*Applause.*

**Nathalie Rodriguez:** Paraguay. Paraguay.

*Discussions at the Tribune and in the audience.*

**Nathalie Rodriguez:** So, Paraguay is not in the hall.

**Nathalie Rodriguez:** If Paraguay is not here, then we have to close the list of the Federations because Paraguay was the last one. I repeat the votes. You have all received the proposals from the Ukrainian Federation. You have them. The first proposal will be divided into two votes. Please do not open the vote yet. I am still explaining.

- The first one is to suspend the membership of the Russian Fencing Federation.
- The second one is to suspend the membership of the Belarusian Federation.
- And the third one is not allowing athletes, coaches, and officials from Russia and Belarus to participate in FIE competitions.

So, there will be three votes. For vote number one and vote number... Yes, I ask you to remove what is on the screen. So, we have:

- *Proposal 1A* from the Ukrainian Federation to suspend the membership of the Russian Fencing Federation.
- *Proposal 1B* from the Ukrainian Fencing Federation to suspend the membership of the Belarusian Federation.
- And *Proposal 2* from the Ukrainian Fencing Federation not to allow athletes, coaches, officials, etc., from the Russian Fencing Federation and the Belarusian Federation to participate in the FIE competitions.

So, three votes: for vote #1 and vote #3, simple majority. For vote #2, majority of three-fourths. Is it clear?

**Ana Irene Delgado Guerra (PAN):** They want explanations one by one.

**Nathalie Rodriguez:** This is exactly what I just said. Yes.

**Ilgar Mamedov (RUS):** Nathalie, if the first and the second proposals are easy to understand, the third one is not easy. Not to allow. To allow and not to allow. Maybe you can change the first word, to allow because, for voting, it is easy to vote yes or no, but not to allow; what do I have to push? You understand this, but not everyone.

**Nathalie Rodriguez:** Excuse me, please read the proposals that you have received, you all have them.

*Proposal 1* is to suspend the membership, and *Proposal 2* is not to allow the athletes, etc. etc. to participate in the FIE competitions. In other words, to forbid, to suspend, to whatever...

**Ilgar Mamedov (RUS):** Yes, yes, this is more understandable. It is my opinion. Maybe you have another opinion. Because if someone cannot push the button to recognize a new Federation, can you imagine how hard this can be? It is very important for us. Therefore, I am here.

**Nathalie Rodriguez:** But what we are going to ask the Federations is the following:

Do you agree with the proposals from Ukraine? This is what we are going to ask for *Proposal 1*. Do you agree? Yes, no. *Proposal 2*. Do you agree? Yes, no. *Proposal 3*. Do you agree? Yes, no.

**Emmanuel Katsiadakis (MH):** It is clear.

**Nathalie Rodriguez:** I said 1A, 1B, and 2, but there will be three votes.

*Discussions and exclamations in the audience*

**Nathalie Rodriguez:** It is written. Did you read the *Proposal*? I will read it to you.

*“Not to allow athletes, coaches, officials holding Russian or Belarusian citizenship and licenses registered by the Russian Fencing Federation and/or the Belarus Fencing Federation to participate in competitions of the FIE.”*

That is, all the fencers holding Russian and Belarusian citizenship and licenses registered by the Russian Fencing Federation or the Belarus Fencing Federation should not be allowed to participate in competitions. This is what is written. You just have to read.

*Discussions and exclamations in the audience*

So, *Proposal 1A* is to suspend the membership of the Russian Fencing Federation. In this, we ask you if you are in favour of this proposal or not in favour of this proposal. Is it clear to everyone?

**People in the audience:** Yes, yes.

**Nathalie Rodriguez:** It is *Proposal 1A*. So, if you agree with the proposal, you vote yes. If you disagree with the proposal, you vote no, and if you abstain, then you abstain.

*Discussions and exclamations in the audience*

**Nathalie Rodriguez:** Please. We are going to open the vote, and you will have to vote because this is an important issue.

So, we open the vote. The vote is open.

The vote is closed.

*Applause.*

The proposal did not pass.

*Proposal 1B* of the Ukrainian Federation is to suspend the membership of the Belarus Fencing Federation. For that proposal to pass, according to the Legal Commission, the three-fourths of the votes are needed.

So, we open the vote on *Proposal 1B*. The vote is open.

The vote is closed.

*Applause.*

The proposal did not pass.

*Proposal 2* from the Ukrainian Fencing Federation: not to allow the athletes, coaches, officials holding Russian or Belarusian citizenship and licenses to participate in competitions of the FIE.

So, we are going to open the vote on this proposal. The vote is open.

The vote is closed.

The proposal did not pass.

*Applause.*

And we now move to the coffee break.

*Applause.*

*(Coffee Break)*

## 15. 2023 Chevalier Feyerick Challenge

**Nathalie Rodriguez:** The Honours Commission met during the lunch time and was presented with the proposal from the Executive Committee to award the Challenge Chevalier Feyerick 2023 to Mrs. Ana Pascu posthumously.

*Applause.*

**Nathalie Rodriguez:** The motivation of this proposal was: "For having rendered inestimable services to the FIE and in recognition of Ana Pascu's immeasurable contribution to international fencing, her remarkable and inspirational dedication and devotion to the cause of sport and her constant wisdom, benevolence, loyalty, and fair play under all circumstances and with everyone."

*Applause.*

We ask the Fencing Federation of Romania to come and receive the Trophy of the Challenge Chevalier Feyerick 2023.

*Award is presented.*

*Applause.*

## 16. 2023 Fair-Play Trophy

**Nathalie Rodriguez:** The 2023 Fair-Play Trophy has been awarded by the Executive Committee based on proposals from the Fair-Play Council to:

- Maria Akshita Ciril Rajdev from India

*Applause.*

*Award is presented.*

*Applause.*

- Lachlan Crook from Australia

*Applause.*

*Award is presented.*

*Applause.*

- Mostafa Tahoun from Egypt

*Applause.*

*Award is presented.*

*Applause.*

## 17. Winners of the 2023 FIE official rankings and the Nations' Grand Prix

**Nathalie Rodriguez:** For the next item, which is the *Winners of the 2023 FIE official rankings and the Nations' Grand Prix*, I would like to ask the members of the Executive Committee to come to the Tribune to award the athletes. We will start with the Individual Junior fencers at each weapon:

### Individual Junior Rankings

Women's Épée – Hadley Husisian from the USA  
*Applause.*

Men's Épée – Mohammed Elsayed from Egypt  
*Applause.*

Women's Foil – Aurora Grandis from Italy  
*Applause.*

Men's Foil – Damiano Di Veroli from Italy  
*Applause.*

Women's Sabre – Nisanur Erbil from Türkiye  
*Applause.*

Men's Sabre – Colin Heathcock from the USA  
*Applause.*

### Junior Team Ranking Winners

Women's Épée – Poland  
*Applause.*

Men's Épée – Egypt  
*Applause.*

Women's Foil – USA  
*Applause.*

Men's Foil – USA  
*Applause.*

Women's Sabre – Hungary  
*Applause.*

Men's Sabre – Uzbekistan  
*Applause.*



### **Individual Senior Rankings**

Women's Épée – Marie-Florence Candassamy, France

*Applause.*

Men's Épée – Davide Di Veroli, Italy

*Applause.*

Women's Foil – Lee Kiefer from the USA

*Applause.*

Men's Foil – Alexander Massialas, USA

*Applause.*

Women's Sabre – Sara Balzer, France

*Applause.*

Men's Sabre – Sandro Bazadze, Georgia

*Applause.*

### **Senior Team Ranking Winners**

Women's Épée – Korea

*Applause.*

Men's Épée – France

*Applause.*

Women's Foil – Italy

*Applause.*

Men's Foil – Japan

*Applause.*

Women's Sabre – France

*Applause.*

Men's Sabre – Korea

*Applause.*

### **Nations' Grand Prix**

Juniors Grand Prix of the Nations – USA

Cadets Grand Prix of the Nations – Hungary

Seniors Grand Prix of the Nations – Italy

Veterans Grand Prix of the Nations – USA

*Discussions and exclamations in the audience.*

*Applause.*

**Someone at the Tribune:** Nathalie, Nathalie, where is Hungary?

**Nathalie Rodriguez:** I have called everyone. I said: the Juniors – USA, the Cadets – Hungary, the Seniors – Italy, and the Veterans – USA.

**Nathalie Rodriguez:** Is Hungary here? Then we are done. Thank you very much.

## 18. Any other business. Final Remarks.

**Emmanuel Katsiadakis (MH):** Thank you, Nathalie. I would like to make two announcements.

First of all, we celebrate 110 years this year, which means that our Federation works and goes up.

And the second one is also very important for financial reasons. We are very close to signing a contract with Nike, one of the best and biggest sports companies. Nike is a company that sponsors the International Olympic Committee. Therefore, it is very important for us to have this company working with us. It is a very, very good solution for our Federation as well as for the publicity of our Federation because this company is well known all over the world in the field of sports. So, I think it is very important for us.

Another significant topic. Perhaps for many people, some things do not seem very important, but they are very important. Fencing will be included into the programme of the Olympic Games in LA after the decision of the Executive Board of the IOC. We have time for it, at least until LA 2028. And some people will be working on the qualification system because we have time to find a solution.

I would like to thank you very much for this meeting. It was a very emotional meeting for me, but also a very good one for all of us, in a good atmosphere, of course. There are some disappointments for some people, but we work with democracy, and we will continue to do it. I would like to thank very much all my colleagues in the Executive Committee for all their hard work related to this.

Already our CEO have said about our staff, how unbelievably good they are and how much they help us.

And finally, I will say the biggest thank you to the heart of our Federation, the CEO, Mme. Nathalie Rodriguez.

*Applause.*

The dinner is at eight o'clock at the Savoy Hotel. Again, I thank you very much you enjoy the rest of the day.

*Applause.*

**Peter Jacobs (MH, GBR):** I think we ought to take the opportunity to thank Nathalie and the FIE team for all the preparatory work they did for us here and also all the helpers from the Egyptian Federation who helped make this Congress happen.

*Applause.*

## Annexes



---

Box given / Boitiers distribués :	136	
Box Participants :	126	Box
Abstentions :	0	Vote(s)
Nul :	0	Vote(s)
Valid Ballots / Votes valables :	126	Vote(s)
Majority:	64	Vote(s)

\* = Majority

**YES / OUI : \*124**

**NO / NON : 2**

---

Box given / Boitiers distribués :	136	
Box Participants :	117	Box
Abstentions :	0	Vote(s)
Nul :	0	Vote(s)
Valid Ballots / Votes valables :	117	Vote(s)
Majority:	59	Vote(s)

\* = Majority

**YES / OUI : \*117**

**NO / NON : 0**

---

Box given / Boitiers distribués :	136	
Box Participants :	129	Box
Abstentions :	1	Vote(s)
Nul :	0	Vote(s)
Valid Ballots / Votes valables :	128	Vote(s)
Majority:	65	Vote(s)

\* = Majority

**YES / OUI : \*126**

**NO / NON : 2**



---

Box given / Boitiers distribués :	136	
Box Participants :	133	Box
Abstentions :	1	Vote(s)
Nul :	0	Vote(s)
Valid Ballots / Votes valables :	132	Vote(s)
Majority:	67	Vote(s)

\* = Majority

**YES / OUI : \*130**

**NO / NON : 2**

---

Box given / Boitiers distribués :	136	
Box Participants :	131	Box
Abstentions :	1	Vote(s)
Nul :	0	Vote(s)
Valid Ballots / Votes valables :	130	Vote(s)
Majority:	66	Vote(s)

\* = Majority

**YES / OUI : \*129**

**NO / NON : 1**

---

Box given / Boitiers distribués :	136	
Box Participants :	130	Box
Abstentions :	0	Vote(s)
Nul :	0	Vote(s)
Valid Ballots / Votes valables :	130	Vote(s)
Majority:	66	Vote(s)

\* = Majority

**YES / OUI : \*127**

**NO / NON : 3**

---

Box given / Boitiers distribués :	136	
Box Participants :	129	Box
Abstentions :	1	Vote(s)
Nul :	0	Vote(s)
Valid Ballots / Votes valables :	128	Vote(s)
Majority:	65	Vote(s)

\* = Majority

**YES / OUI : \*126**

**NO / NON : 2**

---

Box given / Boitiers distribués :	136	
Box Participants :	129	Box
Abstentions :	3	Vote(s)
Nul :	0	Vote(s)
Valid Ballots / Votes valables :	126	Vote(s)
Majority:	65	Vote(s)

\* = Majority

**YES / OUI : \*122**

**NO / NON : 4**

---

Box given / Boitiers distribués :	136	
Box Participants :	132	Box
Nul :	0	Vote(s)
Valid Ballots / Votes valables :	132	Vote(s)
Majority:	67	Vote(s)

\* = Majority

<b>( 1 )</b>	<b>China</b>	<b>*87</b>
<b>( 2 )</b>	<b>Estonia</b>	<b>45</b>

---

Box given / Boitiers distribués :	136	
Box Participants :	132	Box
Abstentions :	2	Vote(s)
Nul :	0	Vote(s)
Valid Ballots / Votes valables :	130	Vote(s)
Majority:	67	Vote(s)

\* = Majority

**YES / OUI : \*120**

**NO / NON : 10**

---

Box given / Boitiers distribués :	136	
Box Participants :	131	Box
Abstentions :	2	Vote(s)
Nul :	0	Vote(s)
Valid Ballots / Votes valables :	129	Vote(s)
Majority:	66	Vote(s)

\* = Majority

**YES / OUI : \*118**

**NO / NON : 11**



---

Box given / Boitiers distribués :	136	
Box Participants :	131	Box
Abstentions :	3	Vote(s)
Nul :	0	Vote(s)
Valid Ballots / Votes valables :	128	Vote(s)
Majority:	66	Vote(s)

\* = Majority

**YES / OUI : \*124**

**NO / NON : 4**

---

Box given / Boitiers distribués :	136	
Box Participants :	127	Box
Abstentions :	4	Vote(s)
Nul :	0	Vote(s)
Valid Ballots / Votes valables :	123	Vote(s)
2/3 Majority / Majorité 2/3 :	85	Vote(s)

\* = Majority

**NO / NON : 70**

**YES / OUI : 53**

---

Box given / Boitiers distribués :	136	
Box Participants :	118	Box
Abstentions :	6	Vote(s)
Nul :	0	Vote(s)
Valid Ballots / Votes valables :	112	Vote(s)
2/3 Majority / Majorité 2/3 :	79	Vote(s)

\* = Majority

**YES / OUI : \*96**

**NO / NON : 16**

---

Box given / Boitiers distribués :	136	
Box Participants :	124	Box
Abstentions :	3	Vote(s)
Nul :	0	Vote(s)
Valid Ballots / Votes valables :	121	Vote(s)
2/3 Majority / Majorité 2/3 :	83	Vote(s)

\* = Majority

**YES / OUI : \*96**

**NO / NON : 25**

---

Box given / Boitiers distribués :	136	
Box Participants :	128	Box
Abstentions :	4	Vote(s)
Nul :	0	Vote(s)
Valid Ballots / Votes valables :	124	Vote(s)
2/3 Majority / Majorité 2/3 :	86	Vote(s)

\* = Majority

**YES / OUI : \*116**

**NO / NON : 8**

---

Box given / Boitiers distribués :	136	
Box Participants :	126	Box
Abstentions :	4	Vote(s)
Nul :	0	Vote(s)
Valid Ballots / Votes valables :	122	Vote(s)
2/3 Majority / Majorité 2/3 :	84	Vote(s)

\* = Majority

**YES / OUI : \*109**

**NO / NON : 13**

---

Box given / Boitiers distribués :	136	
Box Participants :	129	Box
Abstentions :	4	Vote(s)
Nul :	0	Vote(s)
Valid Ballots / Votes valables :	125	Vote(s)
2/3 Majority / Majorité 2/3 :	86	Vote(s)

\* = Majority

**YES / OUI : \*108**

**NO / NON : 17**

---

Box given / Boitiers distribués :	136	
Box Participants :	131	Box
Abstentions :	4	Vote(s)
Nul :	0	Vote(s)
Valid Ballots / Votes valables :	127	Vote(s)
2/3 Majority / Majorité 2/3 :	88	Vote(s)

\* = Majority

**YES / OUI : 85**

**NO / NON : 42**



---

Box given / Boitiers distribués :	136	
Box Participants :	130	Box
Abstentions :	7	Vote(s)
Nul :	0	Vote(s)
Valid Ballots / Votes valables :	123	Vote(s)
2/3 Majority / Majorité 2/3 :	87	Vote(s)

\* = Majority

**YES / OUI : \*99**

**NO / NON : 24**

---

Box given / Boitiers distribués :	136	
Box Participants :	127	Box
Abstentions :	0	Vote(s)
Nul :	0	Vote(s)
Valid Ballots / Votes valables :	127	Vote(s)
2/3 Majority / Majorité 2/3 :	85	Vote(s)

\* = Majority

**YES / OUI : \*117**

**NO / NON : 10**

---

Box given / Boitiers distribués :	136	
Box Participants :	127	Box
Abstentions :	1	Vote(s)
Nul :	0	Vote(s)
Valid Ballots / Votes valables :	126	Vote(s)
2/3 Majority / Majorité 2/3 :	85	Vote(s)

\* = Majority

**YES / OUI : \*117**

**NO / NON : 9**

---

Box given / Boitiers distribués :	136	
Box Participants :	132	Box
Abstentions :	2	Vote(s)
Nul :	0	Vote(s)
Valid Ballots / Votes valables :	130	Vote(s)
2/3 Majority / Majorité 2/3 :	88	Vote(s)

\* = Majority

**YES / OUI : \*120**

**NO / NON : 10**

---

Box given / Boitiers distribués :	136	
Box Participants :	128	Box
Abstentions :	2	Vote(s)
Nul :	0	Vote(s)
Valid Ballots / Votes valables :	126	Vote(s)
2/3 Majority / Majorité 2/3 :	86	Vote(s)

\* = Majority

**YES / OUI : \*119**

**NO / NON : 7**

---

Box given / Boitiers distribués :	136	
Box Participants :	128	Box
Abstentions :	4	Vote(s)
Nul :	0	Vote(s)
Valid Ballots / Votes valables :	124	Vote(s)
Majority:	65	Vote(s)

\* = Majority

**YES / OUI : \*101**

**NO / NON : 23**

---

Box given / Boitiers distribués :	136	
Box Participants :	120	Box
Abstentions :	6	Vote(s)
Nul :	0	Vote(s)
Valid Ballots / Votes valables :	114	Vote(s)
Majority:	61	Vote(s)

\* = Majority

**YES / OUI : \*110**

**NO / NON : 4**

---

Box given / Boitiers distribués :	136	
Box Participants :	128	Box
Abstentions :	3	Vote(s)
Nul :	0	Vote(s)
Valid Ballots / Votes valables :	125	Vote(s)
Majority:	65	Vote(s)

\* = Majority

**YES / OUI : \*104**

**NO / NON : 21**



---

Box given / Boitiers distribués :	136	
Box Participants :	129	Box
Abstentions :	3	Vote(s)
Nul :	0	Vote(s)
Valid Ballots / Votes valables :	126	Vote(s)
Majority:	65	Vote(s)

\* = Majority

**YES / OUI : \*108**

**NO / NON : 18**

---

Box given / Boitiers distribués :	136	
Box Participants :	125	Box
Abstentions :	4	Vote(s)
Nul :	0	Vote(s)
Valid Ballots / Votes valables :	121	Vote(s)
Majority:	63	Vote(s)

\* = Majority

**YES / OUI : \*91**

**NO / NON : 30**

---

Box given / Boitiers distribués :	136	
Box Participants :	127	Box
Abstentions :	6	Vote(s)
Nul :	0	Vote(s)
Valid Ballots / Votes valables :	121	Vote(s)
Majority:	64	Vote(s)

\* = Majority

**YES / OUI : \*100**

**NO / NON : 21**

---

Box given / Boitiers distribués :	136	
Box Participants :	122	Box
Abstentions :	4	Vote(s)
Nul :	0	Vote(s)
Valid Ballots / Votes valables :	118	Vote(s)
Majority:	62	Vote(s)

\* = Majority

**YES / OUI : \*106**

**NO / NON : 12**

---

Box given / Boitiers distribués :	136	
Box Participants :	121	Box
Abstentions :	1	Vote(s)
Nul :	0	Vote(s)
Valid Ballots / Votes valables :	120	Vote(s)
Majority:	61	Vote(s)

\* = Majority

**YES / OUI : \*113**

**NO / NON : 7**

---

Box given / Boitiers distribués :	136	
Box Participants :	117	Box
Abstentions :	3	Vote(s)
Nul :	0	Vote(s)
Valid Ballots / Votes valables :	114	Vote(s)
Majority:	59	Vote(s)

\* = Majority

**YES / OUI : \*99**

**NO / NON : 15**

---

Box given / Boitiers distribués :	136	
Box Participants :	121	Box
Abstentions :	2	Vote(s)
Nul :	0	Vote(s)
Valid Ballots / Votes valables :	119	Vote(s)
Majority:	61	Vote(s)

\* = Majority

**YES / OUI : \*116**

**NO / NON : 3**

---

Box given / Boitiers distribués :	136	
Box Participants :	114	Box
Abstentions :	2	Vote(s)
Nul :	0	Vote(s)
Valid Ballots / Votes valables :	112	Vote(s)
Majority:	58	Vote(s)

\* = Majority

**YES / OUI : \*109**

**NO / NON : 3**



---

Box given / Boitiers distribués :	136	
Box Participants :	116	Box
Abstentions :	0	Vote(s)
Nul :	0	Vote(s)
Valid Ballots / Votes valables :	116	Vote(s)
Majority:	59	Vote(s)

\* = Majority

**YES / OUI : \*111**

**NO / NON : 5**

---

Box given / Boitiers distribués :	136	
Box Participants :	117	Box
Abstentions :	2	Vote(s)
Nul :	0	Vote(s)
Valid Ballots / Votes valables :	115	Vote(s)
Majority:	59	Vote(s)

\* = Majority

**YES / OUI : \*108**

**NO / NON : 7**

---

Box given / Boitiers distribués :	136	
Box Participants :	114	Box
Abstentions :	2	Vote(s)
Nul :	0	Vote(s)
Valid Ballots / Votes valables :	112	Vote(s)
Majority:	58	Vote(s)

\* = Majority

**YES / OUI : \*108**

**NO / NON : 4**

---

Box given / Boitiers distribués :	136	
Box Participants :	127	Box
Abstentions :	0	Vote(s)
Nul :	0	Vote(s)
Valid Ballots / Votes valables :	127	Vote(s)
Majority:	64	Vote(s)

\* = Majority

**YES / OUI : \*124**

**NO / NON : 3**

---

Box given / Boitiers distribués :	136	
Box Participants :	123	Box
Abstentions :	3	Vote(s)
Nul :	0	Vote(s)
Valid Ballots / Votes valables :	120	Vote(s)
Majority:	62	Vote(s)

\* = Majority

**YES / OUI : \*117**

**NO / NON : 3**

---

Box given / Boitiers distribués :	136	
Box Participants :	121	Box
Abstentions :	2	Vote(s)
Nul :	0	Vote(s)
Valid Ballots / Votes valables :	119	Vote(s)
Majority:	61	Vote(s)

\* = Majority

**YES / OUI : \*116**

**NO / NON : 3**

---

Box given / Boitiers distribués :	136	
Box Participants :	124	Box
Abstentions :	2	Vote(s)
Nul :	0	Vote(s)
Valid Ballots / Votes valables :	122	Vote(s)
Majority:	63	Vote(s)

\* = Majority

**YES / OUI : \*111**

**NO / NON : 11**

---

Box given / Boitiers distribués :	136	
Box Participants :	123	Box
Abstentions :	3	Vote(s)
Nul :	0	Vote(s)
Valid Ballots / Votes valables :	120	Vote(s)
Majority:	62	Vote(s)

\* = Majority

**YES / OUI : \*108**

**NO / NON : 12**



---

Box given / Boitiers distribués :	136	
Box Participants :	122	Box
Abstentions :	1	Vote(s)
Nul :	0	Vote(s)
Valid Ballots / Votes valables :	121	Vote(s)
Majority:	62	Vote(s)

\* = Majority

**YES / OUI : \*101**

**NO / NON : 20**

---

Box given / Boitiers distribués :	136	
Box Participants :	122	Box
Abstentions :	1	Vote(s)
Nul :	0	Vote(s)
Valid Ballots / Votes valables :	121	Vote(s)
Majority:	62	Vote(s)

\* = Majority

**YES / OUI : \*114**

**NO / NON : 7**

---

Box given / Boitiers distribués :	136	
Box Participants :	125	Box
Abstentions :	5	Vote(s)
Nul :	0	Vote(s)
Valid Ballots / Votes valables :	120	Vote(s)
Majority:	63	Vote(s)

\* = Majority

**NO / NON : \*74**

**YES / OUI : 46**

---

Box given / Boitiers distribués :	136	
Box Participants :	122	Box
Abstentions :	0	Vote(s)
Nul :	0	Vote(s)
Valid Ballots / Votes valables :	122	Vote(s)
Majority:	62	Vote(s)

\* = Majority

**YES / OUI : \*117**

**NO / NON : 5**

---

Box given / Boitiers distribués :	136	
Box Participants :	125	Box
Abstentions :	1	Vote(s)
Nul :	0	Vote(s)
Valid Ballots / Votes valables :	124	Vote(s)
Majority:	63	Vote(s)

\* = Majority

**YES / OUI : \*122**

**NO / NON : 2**

---

Box given / Boitiers distribués :	136	
Box Participants :	118	Box
Abstentions :	1	Vote(s)
Nul :	0	Vote(s)
Valid Ballots / Votes valables :	117	Vote(s)
Majority:	60	Vote(s)

\* = Majority

**YES / OUI : \*104**

**NO / NON : 13**

---

Box given / Boitiers distribués :	136	
Box Participants :	126	Box
Abstentions :	3	Vote(s)
Nul :	0	Vote(s)
Valid Ballots / Votes valables :	123	Vote(s)
Majority:	64	Vote(s)

\* = Majority

**NO / NON : \*85**

**YES / OUI : 38**

---

Box given / Boitiers distribués :	136	
Box Participants :	126	Box
Abstentions :	1	Vote(s)
Nul :	0	Vote(s)
Valid Ballots / Votes valables :	125	Vote(s)
Majority:	64	Vote(s)

\* = Majority

**YES / OUI : \*119**

**NO / NON : 6**



---

Box given / Boitiers distribués :	136	
Box Participants :	123	Box
Abstentions :	2	Vote(s)
Nul :	0	Vote(s)
Valid Ballots / Votes valables :	121	Vote(s)
Majority:	62	Vote(s)

\* = Majority

**YES / OUI : \*115**

**NO / NON : 6**

---

Box given / Boitiers distribués :	136	
Box Participants :	127	Box
Abstentions :	1	Vote(s)
Nul :	0	Vote(s)
Valid Ballots / Votes valables :	126	Vote(s)
Majority:	64	Vote(s)

\* = Majority

**YES / OUI : \*116**

**NO / NON : 10**

---

Box given / Boitiers distribués :	136	
Box Participants :	126	Box
Abstentions :	5	Vote(s)
Nul :	0	Vote(s)
Valid Ballots / Votes valables :	121	Vote(s)
Majority:	64	Vote(s)

\* = Majority

**YES / OUI : \*105**

**NO / NON : 16**

---

Box given / Boitiers distribués :	136	
Box Participants :	120	Box
Abstentions :	5	Vote(s)
Nul :	0	Vote(s)
Valid Ballots / Votes valables :	115	Vote(s)
Majority:	61	Vote(s)

\* = Majority

**YES / OUI : \*106**

**NO / NON : 9**

---

Box given / Boitiers distribués :	136	
Box Participants :	120	Box
Abstentions :	0	Vote(s)
Nul :	0	Vote(s)
Valid Ballots / Votes valables :	120	Vote(s)
Majority:	61	Vote(s)

\* = Majority

**YES / OUI : \*113**

**NO / NON : 7**

---

Box given / Boitiers distribués :	136	
Box Participants :	116	Box
Abstentions :	1	Vote(s)
Nul :	0	Vote(s)
Valid Ballots / Votes valables :	115	Vote(s)
Majority:	59	Vote(s)

\* = Majority

**YES / OUI : \*113**

**NO / NON : 2**

---

Box given / Boitiers distribués :	136	
Box Participants :	127	Box
Abstentions :	2	Vote(s)
Nul :	0	Vote(s)
Valid Ballots / Votes valables :	125	Vote(s)
Majority:	64	Vote(s)

\* = Majority

**YES / OUI : \*116**

**NO / NON : 9**

---

Box given / Boitiers distribués :	136	
Box Participants :	124	Box
Abstentions :	0	Vote(s)
Nul :	0	Vote(s)
Valid Ballots / Votes valables :	124	Vote(s)
Majority:	63	Vote(s)

\* = Majority

**YES / OUI : \*118**

**NO / NON : 6**



---

Box given / Boitiers distribués :	136	
Box Participants :	120	Box
Abstentions :	1	Vote(s)
Nul :	0	Vote(s)
Valid Ballots / Votes valables :	119	Vote(s)
Majority:	61	Vote(s)

\* = Majority

**YES / OUI : \*117**

**NO / NON : 2**

---

Box given / Boitiers distribués :	136	
Box Participants :	124	Box
Abstentions :	3	Vote(s)
Nul :	0	Vote(s)
Valid Ballots / Votes valables :	121	Vote(s)
Majority:	63	Vote(s)

\* = Majority

**YES / OUI : \*117**

**NO / NON : 4**

---

Box given / Boitiers distribués :	136	
Box Participants :	122	Box
Abstentions :	1	Vote(s)
Nul :	0	Vote(s)
Valid Ballots / Votes valables :	121	Vote(s)
Majority:	62	Vote(s)

\* = Majority

**YES / OUI : \*119**

**NO / NON : 2**

---

Box given / Boitiers distribués :	136	
Box Participants :	125	Box
Abstentions :	2	Vote(s)
Nul :	0	Vote(s)
Valid Ballots / Votes valables :	123	Vote(s)
Majority:	63	Vote(s)

\* = Majority

**YES / OUI : \*116**

**NO / NON : 7**

---

Box given / Boitiers distribués :	136	
Box Participants :	121	Box
Abstentions :	1	Vote(s)
Nul :	0	Vote(s)
Valid Ballots / Votes valables :	120	Vote(s)
Majority:	61	Vote(s)

\* = Majority

**YES / OUI : \*118**

**NO / NON : 2**

---

Box given / Boitiers distribués :	136	
Box Participants :	117	Box
Abstentions :	0	Vote(s)
Nul :	0	Vote(s)
Valid Ballots / Votes valables :	117	Vote(s)
Majority:	59	Vote(s)

\* = Majority

**YES / OUI : \*115**

**NO / NON : 2**

---

Box given / Boitiers distribués :	136	
Box Participants :	116	Box
Abstentions :	0	Vote(s)
Nul :	0	Vote(s)
Valid Ballots / Votes valables :	116	Vote(s)
Majority:	59	Vote(s)

\* = Majority

**YES / OUI : \*111**

**NO / NON : 5**

---

Box given / Boitiers distribués :	136	
Box Participants :	122	Box
Abstentions :	1	Vote(s)
Nul :	0	Vote(s)
Valid Ballots / Votes valables :	121	Vote(s)
Majority:	62	Vote(s)

\* = Majority

**YES / OUI : \*118**

**NO / NON : 3**



---

Box given / Boitiers distribués :	136	
Box Participants :	125	Box
Abstentions :	2	Vote(s)
Nul :	0	Vote(s)
Valid Ballots / Votes valables :	123	Vote(s)
Majority:	63	Vote(s)

\* = Majority

**YES / OUI : \*116**

**NO / NON : 7**

---

Box given / Boitiers distribués :	136	
Box Participants :	117	Box
Abstentions :	1	Vote(s)
Nul :	0	Vote(s)
Valid Ballots / Votes valables :	116	Vote(s)
Majority:	59	Vote(s)

\* = Majority

**YES / OUI : \*113**

**NO / NON : 3**

---

Box given / Boitiers distribués :	136	
Box Participants :	126	Box
Abstentions :	1	Vote(s)
Nul :	0	Vote(s)
Valid Ballots / Votes valables :	125	Vote(s)
Majority:	64	Vote(s)

\* = Majority

**YES / OUI : \*122**

**NO / NON : 3**

---

Box given / Boitiers distribués :	136	
Box Participants :	118	Box
Abstentions :	2	Vote(s)
Nul :	0	Vote(s)
Valid Ballots / Votes valables :	116	Vote(s)
Majority:	60	Vote(s)

\* = Majority

**YES / OUI : \*109**

**NO / NON : 7**

---

Box given / Boitiers distribués :	136	
Box Participants :	133	Box
Abstentions :	0	Vote(s)
Nul :	0	Vote(s)
Valid Ballots / Votes valables :	133	Vote(s)
Majority:	67	Vote(s)

\* = Majority

**NO / NON : \*87**

**YES / OUI : 46**

---

Box given / Boitiers distribués :	136	
Box Participants :	132	Box
Abstentions :	0	Vote(s)
Nul :	0	Vote(s)
Yes/No votes / Votes Oui/Non :	132	Vote(s)
3/4 Majority / Majorité 3/4 :	99	Vote(s)

\* = Majority

**NO / NON : 91**

**YES / OUI : 41**

---

Box given / Boitiers distribués :	136	
Box Participants :	132	Box
Abstentions :	0	Vote(s)
Nul :	0	Vote(s)
Valid Ballots / Votes valables :	132	Vote(s)
Majority:	67	Vote(s)

\* = Majority

**NO / NON : \*91**

**YES / OUI : 41**

*Système de vote électronique / Electronic voting system / Sistema de voto electrónico*

---

1. Les participants choisissent aléatoirement leurs boîtiers.
2. Appuyer sur une des trois touches du boîtier: « **YES-NO-ABST** ».
3. Puis valider **la réponse** en appuyant sur la touche « **VALID** ».
4. **La touche de correction est disponible**, tant que le vote n'a pas été validé. Appuyer sur « **CORR** », **puis reprendre les étapes 2, puis 3.**



- 
1. The participants select their device at random.
  2. Press one of three keys of the device: "YES-NO-ABST".
  3. Then validate **the answer** by pressing the "VALID" key.
  4. **The correction key IS available** as long as the vote has not been validated. Press on "CORR", **then resume stages 2, then 3.**
- 

1. Los participantes escogen libremente el aparato a su gusto.
  2. Apoyar sobre una de las tres teclas del aparato « **YES-NO-ABST** ».
  3. Después **validar la respuesta** apoyando la tecla « **VALID** ».
  4. **Una tecla de corrección « CORR » está a disposición** siempre y cuando no se haya validado el voto. Apoyar sobre « **CORR** » **y retomar las etapas 2 y 3.**
-



## AGENDA

09:30	1	Validation of attendances and proxies
09:50	2	Addresses
10:00	3	Ratification of new federations
	4	Approval of the report of the 2022 Congress held in Lausanne (SUI)
	5	Approval of the report of the 2023 Extraordinary Congress held online
	6	Approval of the 2022 annual report of the Executive Committee
	7	Financial report 2022, auditors' report, approval of the accounts, discharge of the Executive Committee and of the auditors
	8	Budget 2024
	9	Appointment of the auditors for 2024
10:40	10	Vote to award the World Championships: <ul style="list-style-type: none"><li>▪ <b>2025</b> Juniors/Cadets: candidature of CHN/EST</li><li>▪ <b>2025</b> Seniors: candidature of GEO</li><li>▪ <b>2026</b> Juniors/Cadets: candidature of BRA/UZB</li><li>▪ <b>2026</b> Seniors: candidature of HKG</li></ul>
	11	Call for candidatures for the organisation of the World Championships: <ul style="list-style-type: none"><li>▪ <b>2027</b> Juniors/Cadets</li><li>▪ <b>2027</b> Seniors</li><li>▪ <b>2025, 2026 and 2027</b> Veterans</li></ul>
11:15		<i>Coffee break</i>
11:30	12	Proposals submitted to the Congress, reports from the Commissions, Councils and Ethics Committee, urgent decisions regarding the Rules
13:00		<i>Congress photo and lunch</i>
14:30		Continuation of item 12
	13	Progress reports from working groups
	14	Proposals from the Ukrainian Fencing Federation
16:30		<i>Coffee break</i>
16:45	15	2023 Chevalier Feyerick Challenge
	16	2023 Fair Play Trophy
	17	Winners of the 2023 FIE official rankings and of Nations' Grand Prix
	18	Any other business
17:45		<i>End of the Congress</i>



# 100th Congress

26<sup>TH</sup> NOVEMBER 2022  
LAUSANNE, SWITZERLAND

## CONTENTS

<b>Contents</b>	<b>2</b>
<b>Attendance</b>	<b>3</b>
<b>Present or Represented Federations</b>	<b>4</b>
<b>Agenda</b>	<b>9</b>
<b>Validation of attendance and proxies</b>	<b>10</b>
<b>Addresses</b>	<b>12</b>
<b>Ratification of the New Federations</b>	<b>14</b>
<b>Ratification of the Executive Committee's decisions regarding the appointment of the Interim President</b>	<b>15</b>
<b>2021 Annual Report of the Executive Committee</b>	<b>18</b>
<b>2021 Financial report, auditors' report, approval of the accounts, discharge to the Executive Committee and to the auditors</b>	<b>19</b>
<b>2023 Budget</b>	<b>20</b>
<b>Appointment of auditors</b>	<b>22</b>
<b>Vote to award the World Championships</b>	<b>23</b>
2024 Juniors/Cadets, candidature of KSA	
<b>Call for candidatures for the organisation of the World Championships</b>	<b>26</b>
Juniors/Cadets, 2025, 2026	
Seniors 2025, 2026	
Veterans 2025, 2026	
<b>Proposals submitted to Congress, reports from the Commissions, Councils, and Ethics Committee. Urgent decisions regarding the Rules. Progress reports from working groups</b>	<b>28</b>
<b>Decisions regarding athletes and officials from Russia and Belarus</b>	<b>37</b>
<b>Nominations of Members of Honour</b>	<b>48</b>
<b>2022 Fair-Play Trophy</b>	<b>49</b>
<b>Winners of the 2022 FIE official rankings and Nations Cups</b>	<b>50</b>
<b>Any other business</b>	<b>53</b>
<b>Annexes</b>	<b>57</b>

## Attendance

The meeting opened at 10:00 am.

### Took place at the tribune:

Mr. Emmanuel KATSIADAKIS (MH, GRE)  
Mrs. Ferial Nadira SALHI (ALG)  
Mrs. Ana Irene DELGADO GUERRA (PAN)  
Mr. Abdelmoneim ELHUSSEINY (EGY)  
Mrs. Erika AZE (LAT)  
Mrs. Nathalie RODRIGUEZ M.-H.  
Mr. Dieter LAMMER

Interim President  
Secretary-Treasurer  
Vice-President  
Vice-President  
Vice-President  
CEO  
Sports and Technical Director

### Members of the Executive Committee:

Ms. Velichka HRISTEVA (BUL)  
Mr. Novak PEROVIC (RSA)  
Mr. Oleg PESKOV (KAZ)  
Ms. Rusni ABU HASSAN (MAS)  
Mr. Donald ANTHONY JR (USA)  
Mr. Paolo AZZI (ITA)  
Mr. Yuki OTA (JPN)  
Mr. Bruno GARES (FRA)

### Presidents of the Confederations:

Mr. Giorgio SCARSO (ITA)  
Mrs. Helen SMITH (MH, AUS)  
HH. Engr. Sheikh Salem Sultan S. AL QASIMI (UAE)  
Mr. Mbagnick NDIAYE (SEN)  
Mr. Vitaly LOGVIN (MEX)  
Mr. Ruben LIMARDO (VEN)

President of the European Confederation  
President of the Oceanian Confederation  
President of the Asian Confederation  
President of the African Confederation  
President of Pan-American Confederation  
President of the Athletes Commission

### Absent with apologies:

Mr. Vadym GUTTSAIT (UKR)  
Mr. Haibin WANG (CHN)

Member of the Executive Committee  
Member of the Executive Committee

### Members of Honor:

Mrs. Helen SMITH (AUS)  
Mr. Peter JACOBS (GBR)  
Mr. Emmanuel KATSIADAKIS (GRE)  
Mr. Carl BORACK (USA)  
Mr Sam CHERIS (USA)

## Present or Represented Federations

<b>AFGHANISTAN</b>	Represented by Kazakhstan
<b>ALGERIA</b>	Moussa HAMMACHE
<b>AMERICAN SAMOA</b>	Represented by Australia
<b>ANGOLA</b>	Aida PEREIRA Meven PEREIRA
<b>ANTIGUA AND BARBUDA</b>	Ileathea CABRAL
<b>ARGENTINA</b>	Victor Sergio GROUPIERRE
<b>ARMENIA</b>	Armen GRIGORYAN Samvel ABRAHAMYAN
<b>ARUBA</b>	Migalda Marieta JANSEN DE CUBA Ezzedean VROUJK
<b>AUSTRALIA</b>	Vincent ELIAS
<b>AUSTRIA</b>	Ursula HINTERSEER Peter BRIGOLA
<b>AZERBAIJAN</b>	Vasif MAMMADOV
<b>BAHRAIN</b>	Ebrahim ALKHALIFA
<b>BARBADOS</b>	Ralph YORK
<b>BELARUS</b>	Vitali SOKOLOVSKI Nataliya TSEKHAVA
<b>BELGIUM</b>	Piet WAUTERS
<b>BELIZE</b>	Represented by Costa Rica
<b>BENIN</b>	Tamegnon Jacques OKOUMASSOUN Charles Ulrich DJOSSA
<b>BOLIVIA</b>	Solange HERRERA CLAROS
<b>BOTSWANA</b>	Represented by Angola
<b>BRAZIL</b>	Mirani FERNANDES Arno PERILLIER SCHNEIDER
<b>BRUNEI</b>	Represented by Mongolia
<b>BULGARIA</b>	Velichka HRISTEVA
<b>BURKINA FASO</b>	Represented by Mali
<b>CAMBODIA</b>	Chhay DUONG
<b>CAMEROON</b>	Marcel AMOUGOU Marie Gabrielle Elodie NKODO ETENDE
<b>CANADA</b>	Ping (Michelle) WANG Yann BERNARD Lisa HUZEL Jessica Zi Jia GUO
<b>CAPE VERDE</b>	Maria RAMOS SILVA
<b>CHILE</b>	Maria EBERL
<b>CHINA</b>	Represented by Kyrgyzstan
<b>COLOMBIA</b>	Afranio Luis RESTREPO VILLAROEEL
<b>COSTA RICA</b>	Luis Alberto CRUZ MELENDEZ

<b>CROATIA</b>	Antonio TRCIN Irena SUJIC
<b>CUBA</b>	Alhajadis Ricardo BANDERA MIRANDA
<b>CZECH REPUBLIC</b>	Jirí BERAN Vilem MADR
<b>CYPRUS</b>	Antonis FOURNARIS Constantinos TALLOTIS
<b>DEMOCRATIC REPUBLIC OF CONGO</b>	Pitchou BOLENGE YOMA
<b>DENMARK</b>	Jan SYLVEST JENSEN
<b>DOMINICA</b>	Cody MORRIS
<b>DOMINICAN REPUBLIC</b>	Luis Bernardo CIPRIAN SARO
<b>ECUADOR</b>	Lorena ARROYO Carlos ECHEVERRIA CORDOBA
<b>EGYPT</b>	Abdelmoneim Elhamy ELHUSSEINY
<b>EL SALVADOR</b>	Melissa Elizabeth ALVARENGA RAMIREZ Juan Jose Roberto GÓMEZ
<b>ESTONIA</b>	Aivar PAALBERG
<b>FINLAND</b>	Joonas LYYTINEN
<b>FRANCE</b>	Sylvie LE MAUX Jean Marc GUENET Laura FLESSEL COLOVIC Yannick BOREL Benoit PINCEMAILLE Julien RICHET COOPER
<b>GEORGIA</b>	Represented by Armenia
<b>GHANA</b>	Mohammed MAHADI
<b>GERMANY</b>	Claudia BOKEL Alexander BÖHM Reka SZABO
<b>GREECE</b>	Ioannis LIGNOS
<b>GREAT BRITAIN</b>	Hilary PHILBIN Patricia AIYENURO Janet HUGGINS Georgina USHER Peter JACOBS (MH)
<b>GUAM</b>	Represented by Great Britain
<b>GUATEMALA</b>	Otto Rene VALLADARES BALDERRAMOS
<b>GUINEA</b>	Represented by Senegal
<b>GUYANA</b>	Avinash SOMIR
<b>HAITI</b>	Dukerns Louis JOSEPH
<b>HONDURAS</b>	Marco Antonio IZAGUIRRE RODRIGUEZ
<b>HONG KONG, CHINA</b>	Kyle CHAN
<b>HUNGARY</b>	Zsolt CSAMPA Henriette Brigitte TAMAS
<b>ICELAND</b>	Nikolay Ivanov MATEEV

<b>INDONESIA</b>	Reni HAMZULIDA
<b>INDIA</b>	Satej Dnyandeo PATIL
<b>IRAN</b>	Alireza POURSALEMANI
<b>IRAQ</b>	Zeyad SALEEM Atheer IDEN
<b>IRELAND</b>	Ursula KAPPUS Nuala MCGARRITY
<b>ISRAEL</b>	Gregory GROSS Alexander IVANOV
<b>ITALY</b>	Giuseppe CAFIERO Giandomenico VARALLO Alberto ANCARANI Maurizio RANDAZZO
<b>IVORY COAST</b>	Zadi Theodore GOGOUA
<b>JAMAICA</b>	James MCBEAN Kevin JACKSON
<b>JAPAN</b>	Shunsuke SAKA Yusuke AOKI
<b>JORDAN</b>	Khaled ATIYAT Naim DAHBOUR
<b>KAZAKHSTAN</b>	Mirbulat ABUOV
<b>KENYA</b>	Alexandra MALIKA Fred KAMAU
<b>KYRGYZSTAN</b>	Osmonzhan KASYMOV Bermet ALYBAKOVA Nigora KARIMOVA
<b>KOREA</b>	Kiyoung KWON Jong Hyung CHO
<b>KUWAIT</b>	Rashed ALSHAMALI
<b>LATVIA</b>	Baiba BRANDULE
<b>LEBANON</b>	Georges ZEIDAN Jihad SALAMEH
<b>LIBYA</b>	Dhw TOUMI
<b>LITHUANIA</b>	Vytautas POLUJANSKAS
<b>LUXEMBOURG</b>	Pascal TESCH
<b>NORTH MACEDONIA</b>	Zoran STOJANOVIC Biljana KUZMANOVSKA NIKOLOVSKA
<b>MADAGASCAR</b>	Harinelina Mickael RAKOTONDRAMANANA
<b>MALAYSIA</b>	Rusni ABU HASSAN
<b>MALI</b>	Wahabou ZOROME
<b>MAURITANIA</b>	Represented by Morocco
<b>MAURITIUS</b>	Jennifer ISRAM Veena GUNPUT
<b>MEXICO</b>	Jorge CASTRO Ana Elizabeth GONZALEZ

<b>MOLDOVA</b>	Olga COJOCARI
<b>MONGOLIA</b>	Ganbaatar DORJSUREN
<b>MOROCCO</b>	Youssef FATHI Adil CHAIB
<b>MYANMAR</b>	Kyaw Moe NAING
<b>NAMIBIA</b>	Dillon KOTZÉ
<b>NEPAL</b>	Sunil Kumar SHRESTHA
<b>NETHERLANDS</b>	Leon PIJNAPPEL Etienne VAN CANN
<b>NEW ZEALAND</b>	David ELDER
<b>NICARAGUA</b>	William CALDERON
<b>NIGER</b>	Halilou SANI
<b>NIGERIA</b>	Adeyinka SAMUEL
<b>NORWAY</b>	Bjørn FAYE
<b>OMAN</b>	Samira ALSHUKAILI Rumaitha AL BUSAIDI
<b>PAKISTAN</b>	Usman AHMED
<b>PALESTINE</b>	Dawoud MITWALI
<b>PANAMA</b>	Jorge VALDES
<b>PAPUA NEW GUINEA</b>	Represented by New Zealand
<b>PARAGUAY</b>	Guido Manuel INSFRAN MAYANS
<b>PERU</b>	Represented by Paraguay
<b>PHILIPPINES</b>	Maria Cristina BATE Leah GONZALEZ
<b>POLAND</b>	Tadeusz TOMASZEWSKI Jacek SLUPSKI Jacek BIERKOWSKI
<b>PORTUGAL</b>	Frederico VALARINHO Clauso NEVES
<b>PUERTO RICO</b>	Juan Carlos RAMIREZ CONCEPCION Hipolito Antonio VAZQUEZ CORIANO
<b>QATAR</b>	Fahad AL-MULLA Abdulla AL-MAADEED
<b>ROMANIA</b>	Marius Cristian BARLADEANU Anca Ioana Ileana IONESCU Roxana BARLADEANU Marius FLOREA
<b>RUSSIA</b>	Ilgar MAMEDOV Mariia SERENKO
<b>RWANDA</b>	Represented by Niger
<b>SAMOA</b>	Represented by Canada
<b>KINGDOM OF SAUDI ARABIA</b>	Ahmed ALSABBAN Abdullah ALSUNAID
<b>SENEGAL</b>	Mamadou SY Oumar MAIGA



<b>SERBIA</b>	Dejan RUSKI Vukasin STOSIC
<b>SINGAPORE</b>	Represented by Hong Kong, China
<b>SLOVAK REPUBLIC</b>	Represented by Czech Republic
<b>SLOVENIA</b>	Rok PONIKVAR
<b>SOUTH AFRICA</b>	Louise LOMBARD Michael STAFFORD
<b>SPAIN</b>	Jose Luis ABAJO GOMEZ Jose Luis ALVAREZ GIL DE TEJADA Antonio GARCIA HERNANDEZ
<b>SRI LANKA</b>	Ajith SIYAMBALAPITIYA Percy FONSEKA
<b>SWITZERLAND</b>	Olivier CARRARD Janine LAMON Christian BAROZZI Lars Henrik FRAUCHIGER
<b>SWEDEN</b>	Otto DRAKENBERG Ana VALERO-COLLANTES
<b>SYRIA</b>	Ahmad ALREFAAI Hussain SHAKER
<b>CHINESE TAIPEI</b>	Kovacs LIN
<b>TAJIKISTAN</b>	Turai ABDURAKHMOM
<b>TURKMENISTAN</b>	Represented by Uzbekistan
<b>THAILAND</b>	Chanchai YOSSUNDARA Arnon KLUENSUWAN
<b>TOGO</b>	Represented by Ghana
<b>TUNISIA</b>	Ziad FERIANI Salah FERJANI Mohamed Sofiane CHAOUACHI
<b>TÜRKIYE</b>	Murat ATALI Mehmet Onursal CIN
<b>UGANDA</b>	Represented by Kenya
<b>UKRAINE</b>	Olga KHARLAN Sergii MISHCHENKO Nataliia CONRAD
<b>UNITED ARAB EMIRATES</b>	Mousa ALBLOOSHI
<b>UNITED STATES OF AMERICA</b>	Samuel David CHERIS (MH) Rita COMES Carl BORACK (MH) Jennifer YAMIN
<b>URUGUAY</b>	Luis FILARDI
<b>UZBEKISTAN</b>	Gulnora SAIDOVA
<b>VENEZUELA</b>	Francisco Rafael MARÍN ALVAREZ
<b>VIETNAM</b>	Le Quang PHUNG
<b>VIRGIN ISLANDS</b>	Represented by Uruguay
<b>YEMEN</b>	Mohammed AL-SALEHI

## Agenda

- 1.** Validation of attendance and proxies
- 2.** Addresses
- 3.** Ratification of the new federations
- 4.** Ratification of the Executive Committee's decisions regarding the appointment of the Interim President
- 5.** 2021 Annual Report of the Executive Committee
- 6.** 2021 Financial report, auditors' report, approval of the accounts, discharge to the Executive Committee and to the auditors
- 7.** 2023 Budget
- 8.** Appointment of the auditors
- 9.** Vote to award the organisation of the World Championships:
  - 2024 Juniors/Cadets, candidature of KSA
- 10.** Call for candidatures to organise the World Championships:
  - Juniors/Cadets 2025, 2026
  - Seniors 2025, 2026
  - Veterans 2025, 2026
- 11.** Proposals submitted to Congress, reports from the Commissions, Councils and Ethics Committee. Urgent decisions regarding the Rules. Progress reports from working groups
- 12.** Decisions regarding athletes and officials from Russia and Belarus
- 13.** Nominations of Members of Honour
- 14.** 2022 Fair-Play Trophy
- 15.** Winners of the 2022 FIE official rankings and Nations Cups
- 16.** Any other business

## 1. Validation of attendance and proxies

**Nathalie Rodriguez:** Good morning, everyone. Please take your seats. We are going to start the Congress. We are going to start with the Validation of attendance and proxies. When I call your federation, please raise your hand, and a voting device will be given to you. After the attendance, we will move to the proxies.

Algeria	Germany	Nicaragua
Angola	Ghana	Netherlands
Antigua and Barbuda	Greece	Nepal
Argentina	Guatemala	Nigeria
Armenia	Guyana	Niger
Aruba	Haiti	Norway
Australia	Hong Kong, China	New Zealand
Austria	Honduras	Oman
Azerbaijan	Hungary	Pakistan
Bahamas - Bahamas is not here.	Indonesia	Panama
Barbados	India	Paraguay
Belgium	Iran	Philippines
Benin	Ireland	Palestine
Belarus	Iraq	Poland
Bolivia	Iceland	Portugal
Brazil	Israel	Puerto Rico
Canada	Italy	Qatar
Bahrain	Jamaica	South Africa
Bulgaria	Jordan	Romania
Cambodia	Japan	Russia
Congo - Congo is not here.	Kazakhstan	Senegal
Chile	Kenya	Sierra Leone
Ivory Coast	Kyrgyzstan	- Sierra Leone is not here.
Cameroon	Korea	Serbia
Colombia	Saudi Arabia	Slovenia
Democratic Republic of Congo	Kuwait	Switzerland
Cape Verde	Latvia	Sweden
Costa Rica	Libya	Syria
Croatia	Lebanon	Thailand
Cuba	Lithuania	Tajikistan
Cyprus	Luxembourg	Chinese Taipei
Denmark	Madagascar	Tunisia
Czech Republic	Morocco	Türkiye
Dominica	Malaysia	United Arab Emirates
Dominican Republic	Moldova	Ukraine
Spain	Mexico	Uruguay
Egypt	Mongolia	USA
Estonia	North Macedonia	Uzbekistan
El Salvador	Mali	Venezuela
Finland	Mauritius	Vietnam
France	Myanmar	Yemen
Great Britain	Namibia	

Is there any Federation that I did not call? Sorry, which country? Ecuador.

Any other Federation? Yes? Sorry? China is not here and has given a proxy. We will move to the proxies after I have finished with the federations present. So, is there any Federation that is present that I should have called?

**Nathalie Rodriguez:** I will now move to the proxies.

- Afghanistan has given a proxy to Kazakhstan. Does Kazakhstan accept? Yes.
- American Samoa has given a proxy to Australia. Does Australia accept? Thank you.
- Belize has given a proxy to Costa Rica. Does Costa Rica accept? Here.
- Botswana has given a proxy to Angola. Does Angola accept?
- Brunei Darussalam has given a proxy to Mongolia. Does Mongolia accept? Yes, there.
- Burkina Faso has given a proxy to Mali. Does Mali accept? Yes.
- China has given a proxy to Kyrgyzstan. Does Kyrgyzstan accept?
- Georgia has given a proxy to Armenia. Does Armenia accept?
- Guinea has given a proxy to Senegal. Does Senegal accept? Senegal, where is Senegal? Yes.
- Guam has given a proxy to Great Britain. Does Great Britain accept?
- Virgin Islands has given a proxy to Uruguay. Does Uruguay accept? Yes.
- Mauritania has given a proxy to Morocco. Does Morocco accept? Where is Morocco? Yes.
- Peru has given a proxy to Paraguay. Does Paraguay accept?
- Papua New Guinea has given a proxy to New Zealand. Does New Zealand accept? Yes.
- Rwanda has given a proxy to Niger. Does Niger accept? Where is Niger?
- Samoa has given a proxy to Canada. Does Canada accept?
- Singapore has given a proxy to Hong Kong. Does Hong Kong accept? Hong Kong? Yes.
- Sri Lanka has given a proxy to Nepal. Does Nepal accept? Yes.
- Slovakia has given a proxy to the Czech Republic. Does the Czech Republic accept? Thank you.
- Turkmenistan has given a proxy to Uzbekistan. Does Uzbekistan accept? Thank you.
- Togo has given a proxy to Ghana. Does Ghana accept? Where is Ghana?
- Uganda has given a proxy to Kenya. Does Kenya accept? Accepted.

So, we have one hundred twenty-three Federations present and twenty-two represented, totaling one hundred forty-five.

## 2. Addresses

**Nathalie Rodriguez:** We now move to the second item of the agenda, The Addresses to the Congress, and I invite the President of the Swiss Federation to come to the tribune.

**Lars Frauchiger (SUI):** Dear Mr President, Dear members of the Executive Committee, Commissions and Councils, Dear delegates, fencing family, FIE personnel, Dear friends, It is a pleasure to meet here in Lausanne for an Annual Congress. I wish to welcome all of you here in Switzerland.

It is a great honour for me to address Congress again. Last year we were still struggling with a lot of Covid issues. The competitions had just resumed at the international level. A lot of efforts had been made in terms of security and measures against Covid. The organisers of the competitions had a great responsibility. For the athletes and the delegations, it was not always easy. But we stood together, and fencing became possible again at the international level. On top of that, we all had to work for the number of fencers in our Federations to rise again. We had to fight against the problem of losing the number of fencers who no longer came to training. We had to do everything to bring them back. We had to fight for our members. It took us a lot of work, and I think we all succeeded. For this, I am also proud of our fencing family.

Today, Covid is still present. We see it right here, but we face other, maybe bigger problems. We suffer from the energy crisis, inflation, and war – problems we did not see coming one year ago. We also do not know how this will develop in the future. But nevertheless, our sport, sport in general, still exists. We love our sport, and we want to be joyful. We want to be able to meet, to train, to compete. But can we close our eyes to the world around us? This Congress will discuss this matter later. I sincerely hope for the right decision.

Last but not least, I would like to thank the office of the FIE for organizing this Congress one more time. Dear Madame Rodriguez, dear Nathalie! Many thanks to you and your team for this effort and big work. And thank you for the work for the FIE and our sport in general. I know the last years were not easy at all. Your team and you did an amazing job.

**Nathalie Rodriguez:** Thank you very much.

**Lars Frauchiger (SUI):** I wish you, I wish us a good Congress. Let's work for our sport. Thank you.

*Applause.*

**Nathalie Rodriguez:** The floor is to the Interim President.

**Emmanuel Katsiadakis (MH):** Dear Friends and Colleagues, Ladies and Gentlemen, On behalf of the International Fencing Federation, I welcome you all in Lausanne for the 2022 Congress.

This Congress is an historical Congress because it is the 100th Congress in the history of the International Fencing Federation.

*Applause.*

It is such a great pleasure to be with you again, in person, and to enjoy this gathering of people from all parts of the world. Our agenda is very heavy today and contains various very important items.

So my speech will be short because we have a lot of work. I am certain that our Congress will conduct its work on that basis and will do its best to ensure the smooth continuation of the FIE and our sport, leading to its further development in the future. I understand that the FIE constitutes a global family made up of many different cultures, points of view, of course, and backgrounds. But above all, a family, we are a family. Always say this because we need it. And it is this diversity that creates our strength. It comes from an understanding of combining each other's best qualities and collaborating with each other, always in the spirit of solidarity, respect, and unity.

Standing united will allow us to face any obstacle and move forward, always protecting the interest of our Federation and our sport, of course.

I am convinced of the strong foundation on which our fencing community is based and confident that fencing will reach new heights in the future. I wish us a very successful Congress. Thank you very much.

*Applause.*

### 3. Ratification of the New Federations

**Nathalie Rodriguez:** We move to the next item, which is the Ratification of the New Federations. We will skip this point because though we received some applications this year, they are still in process. So, we have no new Federations to ratify.

Just a reminder, the voting will be done electronically, and you have received on your table the explanation on the voting device, which you know perfectly by now.

The Congress participants who want to speak must announce their Federation and name and then come to the microphones installed in each alley.

The Commission of Honours, which is made of all the Members of Honour present at the Congress will meet just after the photo of the Congress during the lunch break.

## 4. Ratification of the Executive Committee's decisions regarding the appointment of the Interim President

**Nathalie Rodriguez:** The next item on the agenda is the Ratification of the Executive Committee's Decisions Regarding the Appointment of the Interim President. You all have received the urgent letter regarding this item, and if you do not have any questions, we are going... Yes?

**Otto Drakenberg (SWE):** Good morning, everyone. Good morning, Mr. President, and Fellow Fencers and Friends of Fencing. On this point, I would like to ask, as the President of the Swedish Fencing Federation, why, since the self-suspension of Mr. Usmanov was enforced earlier this year, why has there not been an appointment of a new Secretary-General knowing, that our current President, Mr. Katsiadakis or Interim President, if you will, has then stepped down from the position as Secretary-General and assumed the Interim Presidency? We are currently missing a Secretary-General. Why has there not been an appointment for such a position?

**Nathalie Rodriguez:** Because the Interim President also assumes the role of Secretary-General.

**Otto Drakenberg (SWE):** Assuming you would answer that, and interpreting the Statutes of the FIE, we in Sweden interpret them in a way that we cannot have two Presidents at one time. There is no part of the Statutes of the FIE that enables someone to self-suspend oneself. Therefore, according to us, we only have one President now, and the President now of the FIE is Mr. Katsiadakis, who started off as Secretary-General and then took over as President when President Usmanov took his self-suspension, and therefore, we are missing a Secretary-General at the moment.

**Nathalie Rodriguez:** Not exactly.

**Otto Drakenberg (SWE):** That is exactly how we interpret it. I would be very surprised if all of you would agree with me because you have never agreed with me. But that is how we interpret the Statutes, and we are allowed to make interpretations, Madam.

**Nathalie Rodriguez:** I sometimes agree with you, not always, I agree.

**Otto Drakenberg (SWE):** No, I was not referring to you, Madam, to the audience.

**Nathalie Rodriguez:** No, but there is a gap in the FIE Statutes on that issue, and an interpretation is not a clear text. We do not have it, Congress and the FIE did not plan for that situation. So we can interpret it, that's clear. What we are asking now is the Congress to ratify the decision of the Executive Committee, which was sent to all Federations at the beginning of March.

**Otto Drakenberg (SWE):** And then my reply to that is that the Swedish Federation is absolutely against that, and we think that Mr. Katsiadakis should be appointed the real President, if you will, not Interim, until the next presidential elections in 2024, and swiftly a new Secretary-General should be appointed.

**Nathalie Rodriguez:** This is, again, an interpretation because Alisher Usmanov has been elected by the Congress; he self-suspended himself. And the Executive Committee made the decision to appoint the Secretary-General of the FIE as Interim President.



**Otto Drakenberg (SWE):** We believe that is against the Statutes. And we also know that from the past when similar situations have occurred in the Executive Committee, for instance, a number of years ago when there was a change in political leadership in China, at the same time, there was an Executive Committee member from China who then suddenly could not travel and meet up in the Executive Committee meetings for a repeated or prolonged period of time, then that person was removed from the Executive Committee because of no show, and currently, we can conclude that the former President, Mr. Usmanov, is not showing up at the meetings, and therefore, cannot be the President of the Executive Committee and the FIE.

**Nathalie Rodriguez:** Not exactly. It is true that in the past, one Chinese member of the Executive Committee was absent. The Statutes say that in case of absence after two years, two years, then that person is considered as having resigned. And this is why, at that moment, the next member non-elected of the Executive Committee came into the Executive Committee. It was after two years, and this is what the Statutes say, two years.

**Otto Drakenberg (SWE):** Then we can agree on that part of the Statutes. That at least leaves me with the problem that there is no definition that there is no such thing as self-suspension with the right to come back. And that is why Mr. Katsiadakis must be appointed President of the FIE until the next elections.

**Nathalie Rodriguez:** I think it is up to Congress to decide if they want to ratify the decision of the Executive Committee or not.

**Otto Drakenberg (SWE):** Absolutely. So now I have made my voice heard. It is all being recorded. And I can just encourage all of you; I remember a year ago I was here talking about Olympic qualifications, it is not the topic I will mention now, again. But I was speaking in extreme silence. You could hear needles fall. I just remind you that in a few years, things might be different in the world, and things might be different in the FIE. This is always good to think ahead on which side you want to end up with. So, there with those words, I do not rest my case, but I will stand down. Okay, thank you.

**Nathalie Rodriguez:** Thank you.

*Applause.*

**Nathalie Rodriguez:** I would like to remind you of the decision of the Executive Committee, which you received on March 2nd. "The Executive Committee accepted and ratified the decision of Mr. Alisher Usmanov to suspend the exercise of his duties as President of the FIE. Pursuant to the FIE Statutes, the Executive Committee unanimously appointed the Secretary-General of the FIE, Mr. Emmanuel Katsiadakis, as Interim President. Mr. Emmanuel Katsiadakis has accepted and will therefore assume all the duties provided for in the FIE Statutes and Rules." We are going to open the vote. If you agree with the decision of the Executive Committee, you will vote yes. If you disagree, you will vote no.

The vote will open.

*[Exclamations in the audience]*

Please open the vote.

**Nathalie Rodriguez:** The vote is open. I can confirm.

**Emmanuel Katsiadakis:** Nathalie, can you confirm?

**Nathalie Rodriguez:** It is working. I can confirm. If you have two voting devices, you vote with both because you have a proxy.

**Nathalie Rodriguez:** Just a second. We stop the vote. We are going to make a test to make sure that all is working. So, we are going to make a test and check that you don't have any problem. So, the test vote is open. Is everything working? Do you have any problem with the voting device? Nobody has any problem? So, we close the vote, and we will see the results. It is interesting that for a test vote, we have 17 no.

*(Laughter)*

Okay. So, it looks like it works. And some people didn't want to vote, which was fine for a test. So now we will return to the real vote, and you have to vote this time.

We open the vote on item 4. If you agree with the decision of the Executive Committee, you vote yes; if you do not agree, you vote no.

I wish to remind you that the decisions of the Congress are reached by a simple majority vote cast. And that the total number of votes cast must be at least equal to the majority of all the Federations present or represented at the Congress.

The vote is closed. Item 4 is ratified. I think we can congratulate Emmanuel Katsiadakis.

*Applause.*

## 5. 2021 Annual Report of the Executive Committee

**Nathalie Rodriguez:** The next item on the agenda is the 2021 Annual Report of the Executive Committee, which you all have received, and the floor is to Mr. Katsiadakis.

**Emmanuel Katsiadakis (MH):** During this year, we lost a few people from our fencing family. I would like to ask you to stand up for a few minutes, for a few moments, in memory of these friends who passed away.

*(Movie and minute of silence)*

**Emmanuel Katsiadakis (MH):** Thank you very much.

**Nathalie Rodriguez:** You have already received the Annual Report of The Executive Committee, and if you do not have any questions, we will open the vote on the Annual Report 2021.

The vote is open.

The vote is closed.

The Annual Report 2021 is approved.

## 6. 2021 Financial report, auditors' report, approval of the accounts, discharge of the Executive Committee and of the auditors.

**Nathalie Rodriguez:** The next item on the agenda is the 2021 Financial report, the auditors' report, the approval of the accounts, and the discharge to the Executive Committee and to the auditors, and the floor is to the Secretary-Treasurer.

**Ferial Salhi (ALG):** Good morning everyone. What should be noted about 2021 is that we came out positive because we had a revenue surplus. Our receipts were 20,753,629 CHF, and expenses were 8,123,611 CHF. We also ended up with a capital of 37,018,011 Swiss francs.

There is an error in the transcription and translation into English, as there was actually a profit of 12 million. Do you have any questions to ask?

**Nathalie Rodriguez:** If you do not have any questions, we are going to open the vote on this item.

The vote is open.

The vote is closed.

Item 6 is approved.

## 7. 2023 Budget

**Nathalie Rodriguez:** The next item is the Budget for 2023, and the floor is to the Secretary-Treasurer.

**Ferial Salhi (ALG):** For 2023, we had to reduce the budget because we no longer have the same resources. So, it is a budget that is reduced, but essentially on the CMTV part and the part of the employees, because the employees who left the International Federation have been replaced by service providers. These are the major changes. Do you have any questions?

**Nathalie Rodriguez:** If you do not have any questions... yes. You should maybe keep the microphone, Mr. Drakenberg.

*(Laughter)*

**Otto Drakenberg (SWE):** Budget 2023, background information. We have over the past years in FIE, we have run an expense budget in a non-Olympic year of about 10 million Swiss francs while receiving annual donations of a single individual of about 5 million Swiss francs. The FIE appears to have reserves of around 20 million Swiss francs. The benefactor is Mr. Usmanov, whose status in the FIE is unclear, at least to me. He has suspended himself from exercising his duties as President of the FIE and has been subject to severe restrictions and sanctions issued by at least ten nations in the free world since February 2022. He is now being investigated by countries prosecutors' offices in various countries for tax evasion and money laundering. This puts the FIE in dire financial straits if all funds are associated with Mr. Usmanov and are frozen.

I have a couple of questions that I would like answers on, and if I cannot get those answers today, I will return and request those answers. These questions are addressed to the Treasurer of the FIE, and I ask that they be recorded in the minutes of the Congress. And as I said, if any of the information is not readily available today, which I, of course, have respect for, I ask that the Treasurer submit the requested information in writing no later than ten calendar days after the closing of today's FIE Congress.

First, question - As of today, November 2022, how many bank accounts and how much does the FIE have, and in which bank and country are they located? And who are the signatories on the accounts?

Question #2 - Who has control and discretion in the use of these funds?

Question #3 - Are reserve funds part of Mr. Usmanov's frozen assets, and if so, how far back do restrictions on these funds apply?

Question #4 - There is no doubt that as of March 2022, sanctions are in place that cannot be circumvented until the sanctions against Mr. Usmanov are lifted. What measures has the FIE Executive Committee proposed or adopted to deal with the sudden freezing of these funds and a possible international investigation for tax evasion and money laundering led by the German Federal Prosecutor's Office?

Question #5 - What about the fiscal and financial responsibility of an association that depends almost exclusively on the generosity of a single individual?

Question #6 - What are the immediate plans to face the cash flow crisis in the medium term and long term?

Question #7 - What is the role of Mr. Usmanov and his associates in the FIE? Is it acceptable to maintain indirect links of FIE Management with one or more persons subject to international sanctions, and especially if in a state of self-suspension?

Question #8 - This is the final question. Right now, the most urgent issue is to establish where the reserves are. Who controls them for the distribution? What about funds already dispersed from such accounts after March 2022?

Do you want me to repeat any of the eight questions?

**Nathalie Rodriguez:** No, as you did not send us your questions in advance, we will have to gather the information and provide it at a later stage. But I can already provide you with some information.

The FIE currently has three banks: one in Switzerland, one in Africa, in Egypt, one in Asia, in the United Arab Emirates. And we are possibly searching for a bank for the Pan American continent, this to avoid the rising bank charges and taxes when we are making payments.

The amounts that are in the FIE bank accounts are currently 30 million Swiss francs. This money is actually the reserve that the FIE constituted with the subsidies we had received from the International Olympic Committee: 15.1 million after the Olympic Games in Tokyo and 15.1 million from the Rio Olympic Games. This money belongs to the FIE completely.

The persons who, according to the Statutes can handle these assets are the Interim President, the Secretary-Treasurer, and I am authorized to make payments for the daily expenses.

These are the main answers that we can provide so far. None of our assets belong to anyone else than the FIE, and none of our assets are frozen.

**Otto Drakenberg (SWE):** Thank you, Madam.

**Nathalie Rodriguez:** You are welcome.

*Applause.*

**Otto Drakenberg (SWE):** Will you commit to providing the answers within ten days, or what do you think is a reasonable time for coming back to Congress?

**Nathalie Rodriguez:** We will do it as quickly as possible, as usual.

**Otto Drakenberg (SWE):** With that, I say thank you.

**Nathalie Rodriguez:** You are welcome. So, if you have no more questions on the budget, we are opening the vote.

The vote is open.

The vote is closed.

The budget is approved.

## 8. Appointment of auditors

**Nathalie Rodriguez:** The next item, item 8, is the nomination, the Appointment of the auditors, and we propose to renew Ernst and Young, which for years have audited our accounts.

We open the vote on item 8.

The vote is closed.

Ernst and Young are re-conducted for another year.

## 9. Vote to award the World Championships

### 2024 Juniors/Cadets, candidature of KSA

**Nathalie Rodriguez:** The next item is the Vote to award the World Championships. So, this year we have the candidature of the Federation of Saudi Arabia for the Junior and Cadet World Championships 2024, and I invite the Federation to come to the tribune to make a presentation on its candidature.

I would also like to precise that the Executive Committee has received a letter from the Federation mentioning and they have the full support of the government on their candidature, that all participants will be granted a visa and a lot of them will even receive an e-visa on arrival. And that all Federations, male and female, will be able to participate. So, the floor is to the Federation.

**Abdullah AlSunaid (KSA):** Good morning, Ladies and Gentlemen, Mr. President, Dear FIE members, It is a great pleasure and honour to be with you here today.

I would like to take this opportunity to thank the FIE for giving us, the Kingdom of Saudi Arabia, the opportunity to represent our capital city Riyadh as a candidate city to host the Cadet and Junior World Championships. Words cannot describe what you might expect if Saudi Arabia could host this prestigious and important event. Therefore, may I present this video, which I hope will catch the essence of what you might expect from our nation.

*[Video presentation]*  
*Applause.*

Ladies and Gentlemen, we are conscious that article 10.4.1 of the Statutes mentions that the Junior and Cadet World Championships should be held during the first two weeks of April. However, due to a month-long worldwide and national celebration ending just after the first week of April, we will be able to start the competition on Friday, the 12th of April, through Saturday, the 20th of April. As a result of these days, we are kindly requesting approval from Congress on our proposed calendar, changing from the 12th to the 20th of April 2024. I will leave the microphone now to Mr. President of the Saudi Fencing Federation, Mr. Ahmed AlSabban. Thank you.

*Applause.*

**Ahmed AlSabban (KSA):** Good morning, Ladies and Gentlemen, Mr. President and Dear fellow FIE members, It is a great pleasure to be with you tonight, representing my country Saudi Arabia.

I would like to thank you for giving us this amazing opportunity. I look forward to seeing you in Saudi Arabia in 2024 and experience the beauty of this yourself. Thank you.

*Applause.*

**Nathalie Rodriguez:** We are going to open the vote on this item, even if we have only one candid... Sorry, yes. Shall I install a microphone at your table?

**Otto Drakenberg (SWE):** I need to talk about this point before the Congress goes to vote, and the severity of what I am saying forces me to take the podium again, although it feels very much now as a one-man show, but I do not take that blame on myself.



So after recent events inside and outside of fencing, the FIE needs to take care and not to further damage the image of fencing in the world. Saudi Arabia is a country at war. Furthermore, the country has a poor reputation when it comes to human rights. The international organization...

*[Exclamations in the audience]*

the international organization, Human Rights Watch, is explicit, and I quote. "Saudi Arabia spends billions of dollars hosting major entertainment, cultural and sporting events as a deliberate strategy to deflect from the country's image as a pervasive human rights violator."

In the presentation of the Federation of Saudi Arabia, there was no mention of the critical human rights questions that needs an answer. For example, how welcome will LGBTQ fencers be? What restrictions...

*[Exclamations, noise in the audience]*

What rest ...?

*[Exclamations, noise in the audience]*

My plane leaves tomorrow afternoon, so if you want to continue to be undemocratic, take your time.

**Someone in the audience:** Excuse me, excuse me. ...to send to your place.

**Otto Drakenberg (SWE):** What restric...?

*[Exclamations, noise in the audience]*

**Someone in the audience:** Excuse me. We want to stop. Excuse me, please stop.

**Otto Drakenberg (SWE):** What restrictions will be ap...? What restrictions will be applied for female participants? How will the security situation be during the course of the Championships, in view of the fact that the country is at war?

**Abdelmoneim Elhamy ElHusseiny (EGY):** Excuse me, excuse me, now we are here to speak on the sport. Nothing to do with what you are going to say now. Please stop it immediately.

*Applause.*

**Someone in the audience:** Yes.

*Applause.*

**Otto Drakenberg (SWE):** We ...

**Abdelmoneim Elhamy ElHusseiny (EGY):** Mr. President, please...

**Otto Drakenberg (SWE):** The Swe...

**Abdelmoneim Elhamy ElHusseiny (EGY):** You should stop immediately.

**Otto Drakenberg (SWE):** No. You should know who you are talking to Mr. Elhamy, then you would not say that to me because I will never refrain from speaking my word in a democratic world.

*[Exclamations, noise in the audience]*

**Otto Drakenberg (SWE):** We, in the Swedish Federation...

*[Exclamations, noise in the audience]*

**Abdelmoneim Elhamy ElHusseiny (EGY):** Mr. President...

**Otto Drakenberg (SWE):** We urge the Congress not to take a decision before the questions I just raised are answered. Therefore, the Swedish Federation suggests that the decision on this proposal is transferred by the Congress to the Executive Comex, which should be responsible for taking an informed decision or finding a replacement for the organiser of these Championships.

Upon taking the decision, the Comex must communicate to all member Federations its assessment of the risks that participating LGBTQ fencers or female fencers will be subject to emotional suffering due to the legislation of the country where the Championships are held and the risks and threats to the brand of fencing that the choice of organizing Federation will cause.

**Nathalie Rodriguez:** So, to answer Mr. Drakenberg. Visas will be provided to all participants from all Federations, male and female. We have that letter.

If the Congress wants to award the World Championships to the Federation, the member Federation of Saudi Arabia, you will vote yes. If you do not want to do it, you will vote no.

*Applause.*

We open the vote.

The vote is closed.

*Applause.*

**Nathalie Rodriguez:** The 2024 Junior and Cadet World Championships are awarded to the Federation of Saudi Arabia.

*Applause.*

## 10. Call for candidatures for the organisation of the World Championships:

- Juniors/Cadets 2025, 2026
- Seniors 2025, 2026
- Veterans 2025, 2026

**Nathalie Rodriguez:** The next item is the Call for candidatures for the organization of the World Championships 2025 and 2026 for the Junior and Cadets, the Seniors, and the Veterans. Is there any Federation which would be interested by a candidature for these events.

**Nathalie Rodriguez:** Sweden?

*(Laughter) Applause.*

**Aivar Paalberg (EST):** Hello. The Estonian Fencing Federation would like to organise the Junior and Cadet World Championship in 2025.

*Applause.*

**Nathalie Rodriguez:** Estonia, 2025. Thank you, we will send you the candidature form for this, but you have time.

**Nathalie Rodriguez:** Yes.

**Kyle Chan (HKG):** Hi. Hong Kong would like to organise the 2026 World Championship for Seniors.

**Nathalie Rodriguez:** Thank you.

*Applause.*

**Nathalie Rodriguez:** You still have time. Yes?

**Mohamed Soufiane Chaouchi (TUN):** The Tunisian Fencing Federation would like to organise the 2026 World Championship for the Veterans in the Island of Djerba.

**Nathalie Rodriguez:** Thank you.

*Applause.*

**Nathalie Rodriguez:** Any other announcements? You still have time to do it until the end of the Congress and also in the coming days. Thank you. Yes.

**Arno Perillier Schneider (BRA):** Brazil wants to propose for 2026, using the legacy from the Games.

**Nathalie Rodriguez:** Which one, Junior, Senior, or Veterans?

**Arno Perillier Schneider (BRA):** Junior and Cadets.

*Applause.*

**Nathalie Rodriguez:** Thank you.

**Jorge Castro (MEX):** Mexico would like to propose its candidature to organise the 2025 World Championship for the Junior and Cadets in Cancun.

*Applause.*

**Nathalie Rodriguez:** Excellent. I suggest now having a few minutes for the coffee break.

*(Coffee Break)*

## 11. Proposals submitted to Congress, reports from the Commissions, Councils, and Ethics Committee. Urgent decisions regarding the Rules. Progress reports from working groups

**Nathalie Rodriguez:** Please take your seats; we are going to resume the meeting. Can you please take your seats? We are moving to the next item of the agenda, which is Proposals submitted to Congress, reports of the Commissions, Councils, and Ethics Committee, and urgent decisions regarding the Rules. I would like to remind you that you have a voting device, and you must use it and vote.

**Nathalie Rodriguez:** We are starting with the modifications to the Statutes. Proposal #1 from the Legal Commission. The Executive Committee was in favour of the proposal as revised by the Legal Commission; if you have no comments, then we can move to the vote.

The vote is open.

Please remember that for the Statutes, two-thirds of the votes are needed for the proposal to pass. The number of the Proposal is #1, as written on the screen, article 1.2.7.

The vote is closed.  
The proposal passed.

Proposal #2 from the Legal Commission. The Executive Committee was in favour of the proposal. We are opening the vote on Proposal #2.

The vote is open.  
The vote is closed.  
The proposal passed.

Proposal #3 from Sweden.  
The Legal Commission was against, and the Executive Committee was not in favour of the proposal. Sweden is asking for the floor.

**Ana Valero-Collantes (SWE):** The aim of this proposal is to have a clarification for the Statutes article that we already have. This is the aim of this proposal, and we think because it is not regulated the process of expulsion or suspension in the article, so this is a proposal. Thank you.

**Nathalie Rodriguez:** So, as I said, the Legal Commission was against the proposal, and the Executive Committee was not in favour of the proposal. We open the vote on this proposal. So, if you agree with the proposal, you vote yes. If you disagree with the proposal, you vote no.

The vote is closed.  
The proposal did not pass.

Proposal #4 from the Legal Commission. The Executive Committee was in favour of the proposal, and we are going to open the vote on this proposal.

The vote is open.  
The vote is closed.  
The proposal passed.

Proposal #5 from the Legal Commission. The Legal Commission proposed that we think again about this proposal to make Congress manageable, and it suggested delaying this proposal until 2023. The Executive Committee agreed with the Legal Commission and would like to postpone this proposal to the next year in order to discuss how Congress could be managed. So, we will have to wait to vote on this proposal. We will move directly to Proposal #6.

Proposal #6 from the Legal Commission, and the Executive Committee was in favour of the proposal.  
We move to the vote, and the vote is open.

The vote is closed.  
The proposal passed.

Proposal #7 from the Legal Commission, which has revised its proposal, and the Executive Committee was in favour of the proposal as revised by the Legal Commission.  
We open the vote on this proposal. The vote is open.

The vote is closed.  
The proposal passed.

Proposal #8 from Sweden. There were various comments on this proposal, and the Executive Committee was not in favour of the proposal. So, we are... yes, Sweden.

**Ana Valero-Collantes (SWE):** Thank you very much for the opportunity. In sports organizations, term limits are increasingly used at the national and international levels today. Why is it not valid for the FIE? The IOC has 12 years of term limits. Several International Sports Federations have introduced term limits, among them important players like FIFA, International Athletics, International Tennis Federation, International Cycling Union, and International Ice Hockey Federation. The use of term limits is highly recommended by organizations in modern sports' good governance like IPACS and organisations like Play the Games and numerous others.

Both Associations of Summer and Winter Olympic International Federations have recommended that all Olympic International Federations should introduce term limits for their Presidents or other key positions. It promotes better governance and avoids monopoly of power around a few individuals. The perceptions and problems with the comments from all the Commissions having an opinion can be perceived as a conflict of interest for some individuals. Therefore, it is up to the Congress today to decide how to implement this decision for the reason we suggest. Our suggestion is to start counting the time limit from the 2024 elections. Thank you very much.

**Nathalie Rodriguez:** Thank you. So, the Legal Commission, the Ethics Committee, and the Executive Committee were not in favour of this proposal. We are opening the vote on this proposal. If you agree with the proposal, you vote yes; if you don't agree with the proposal, you vote no.

The vote is open.  
The vote is closed.  
The proposal did not pass.

Proposal #9 from the Legal Commission. The Executive Committee was in favour of the proposal.  
We open the vote on this proposal.

The vote is closed.  
The proposal passed.

Proposal #10 from the Legal Commission. The Executive Committee was in favour of the proposal as it would potentially allow a larger representation of zones and genders. The Ethics Committee had proposed to postpone this proposal until 2023, when the Code of Procedure will be established. We are not going to vote on Proposal #10, which will be postponed until Congress 2023. We move to Proposal #11.

Proposal #11 from the Legal Commission, and the Executive Committee was in favour of the proposal.

The vote is open.  
The vote is closed.  
The proposal passed.

Proposal #12 from the Swedish Federation. From Sweden, sorry. The Legal Commission was against the proposal, and the Executive Committee was not in favour of the proposal. Yes, please.

**Ana Valero-Collantes (SWE):** Thank you very much. We had a similar proposal before that the Congress approved. For that reason, we withdraw our proposal. Thank you.

**Nathalie Rodriguez:** So, Proposal #12 is withdrawn.

We move to Proposal #13 from the Legal Commission. The Executive Committee was in favour of the proposal as revised by the Legal Commission.

We move to the vote, and the vote is open.  
The vote is closed.  
The proposal passed.

Proposal #14 from the Legal Commission. The Executive Committee was in favour of the proposal as revised by the Legal Commission.

We move to the vote on this proposal, and the vote is open.  
The vote is closed.  
The proposal passed.

Proposal #15 from the Legal Commission. The Executive Committee was in favour of the proposal as revised by the Legal Commission.

We move to the vote on this proposal, and the vote is open.  
The vote is closed.  
The proposal passed.

Proposal #16 from the Legal Commission, the Executive Committee was in favour of the proposal.

We move to the vote, and the vote is open.

The vote is closed.

The proposal passed.

Proposal #17 from the Legal Commission. The Executive Committee was in favour of the proposal.

We move to the vote, and the vote is open.

The vote is closed.

The proposal passed.

Proposal #18 from the Legal Commission. The Executive Committee was in favour of the proposal as revised by the Legal Commission.

We move to the vote on this proposal, and the vote is open. The vote is closed.

The proposal passed.

Proposal #19 from the Legal Commission, and the Executive Committee was in favour of the proposal.

We move to the vote on this proposal, and the vote is open. The vote is closed. The proposal passed.

And we have finished with the proposals regarding the Statutes.

**We are now moving to the proposals regarding the Rules.**

Proposal #1 from the Refereeing Commission. The Commissions were in favour, and the Executive Committee was also in favour.

We move to the vote on this proposal.

The vote is closed.

The proposal passed.

Proposal #2 from the Rules Commission, which has been revised by the Medical Commission. Both the Refereeing Commission and the Executive Committee favour the proposal as revised by the Medical Commission, except that in article t.170, the word injury should not be scratched.

We are opening the vote on this proposal, and the vote is open.

The vote is closed.

The proposal passed.

Proposal #3 from the Legal Commission, and the Executive Committee was in favour of the proposal.

We open the vote on this proposal, and the vote is open.

The vote is closed.

The proposal passed.

Proposal #4 from Sweden. The Executive Committee was not in favour of the proposal. Sweden, please.



**Ana Valero-Collantes (SWE):** Thank you very much. The aim of our proposal is that we believe that the Executive Committee should not be in place to change the selection of referees. For this issue, we do have the experts in the Refereeing Commission since there is no expertise in these matters among the 28 members. However, we appreciate and accept the arguments of the Legal Commission and the Executive Committee. We will return with a new proposal for coming Congresses. Therefore we will withdraw our Proposal #4. Thank you.

**Nathalie Rodriguez:** So, the proposal is withdrawn.

Proposal #5 from the Veterans Council. The Executive Committee, in principle, is in favour of the proposal. However, as this proposal may involve some changes, which have to be tested, the Executive Committee proposes that a test be done in 2025 during the Veteran World Championship to assess the implementation consequences and impact on the organisers. And then, if no major problems are noted, it will become final. However, if some adjustments have to be made based on the experience of 2025, then we will come back with an adapted proposal. The proposal is to make a test on that new text and new proposal in 2025 during the Veterans World Championships and then to see if nothing has to be changed. We vote on conducting a test in 2025, being in principle in favour of the proposal.

We open the vote on this proposal.

The vote is closed.

The proposal passed.

Proposal #6 from the Rules Commission, and the Executive Committee was in favour of the proposal.

We move to the vote on this proposal, and the vote is open.

The vote is closed.

The proposal passed.

Proposal #7 from the Rules Commission, and the Executive Committee was in favour of the proposal.

We move to the vote, and the vote is open.

The vote is closed.

The proposal passed.

Proposal #8 from the Rules Commission, and the Executive Committee was in favour of the proposal.

We open the vote, and the vote is open.

The vote is closed.

The proposal passed.

Proposal #9 from the Federations of Algeria, Egypt, Morocco, Tunisia, and Senegal. The Executive Committee was not in favour of the proposal as the qualification system provides compulsory quotas for all FIE zones with one specification for team qualification. Therefore, increasing the coefficient for the zonal championships would not offer more qualifications to each zone. So, if you are in favour of the proposal, you vote yes; if you are not in favour of the proposal, you vote no.

The vote is open on this proposal. Yes? We stop the vote, please.

**Wahabou Zorome (MLI):** Hello, Everybody. I am the President of the Malian Fencing Federation. I would like to try to explain the motivations that led us to make this proposal. In fact, the zonal competitions, the zonal Championships, are the most important after the World Cup and the others. So, we think it is a better platform for the continents of Africa, Asia, and America to be able to benefit from specific points and to qualify for a major tournament like the Olympics. That said, we know that other continents organise 75% more tournaments than us. So we make a plea for these points to be brought to what is in the request that we made. Thank you for everything. Thanks very much.

*Applause.*

**Nathalie Rodriguez:** We are going to reopen the vote on this proposal. If you agree with the proposal, you vote yes; if you do not agree, you vote no.

The vote is open. Please remember that for the Rules, the proposals pass with a simple majority.  
The vote is closed.

*Applause.*

The proposal passed.

Proposal #10 from the Rules Commission. The Executive Committee was in favour of the proposal and of the modification to the drawing.

We open the vote on this proposal.  
The vote is closed.  
The proposal passed.

Proposal #11 from the SEMI Commission. The Executive Committee was in favour of the proposal with the addition made by the SEMI Commission.

We move to the vote on this proposal, and the vote is open.  
The vote is closed.  
The proposal passed.

Proposal #12 from the Refereeing Commission. The Executive Committee was in favour of the proposal with the revisions from the Rules Commission.

We move to the vote, and the vote is open.  
The vote is closed.  
The proposal passed.

Proposal #13 from the Refereeing Commission. The Executive Committee was in favour of the proposal.

We open the vote on this proposal, and the vote is open.  
The vote is closed.  
The proposal passed.

Proposal #14 from the Refereeing Commission. The drawings have been redesigned and were appended at the end of the proposals. The Executive Committee was in favour of the proposal.

We open the vote, and the vote is open.

The vote is closed.

The proposal passed.

Proposal #15 is a duplication of Proposal #16. We will not vote on Proposal #15 but move directly to Proposal #16 from the Refereeing Commission. The Executive Committee was in favour of the proposal.

The vote is closed.

The proposal passed.

Proposal #17 is a proposal from the Executive Committee on non-combativity. The Refereeing Commission was in favour, the Athletes Commission was in favour, and the Promotion Commission was in favour. The Rules Commission was in favour with some corrections, and the Executive Committee was in favour with the additions from the Rules Commission.

We move to the vote and open the vote for this proposal.

The vote is closed.

The proposal passed.

Proposal #18 from the Rules Commission. This proposal is actually an Urgent Decision made with the Rules Commission. Therefore, we are not going to vote on Proposal #18 as we will vote on the Urgent Decision.

We move to Proposal #19 from the Refereeing Commission. This proposal is also an Urgent Decision, so we are not going to vote on this proposal. We will vote on the Urgent Decision. We move to Proposal #20.

Proposal #20 from the SEMI Commission. The Executive Committee was in favour of the proposal.

The vote is open.

The vote is closed.

The proposal passed.

Proposal #21 from the SEMI Commission. The Executive Committee was in favour of the proposal.

We open the vote on this proposal, and the vote is open.

The vote is closed.

The proposal passed.

Proposal #22 from the SEMI Commission. As we still have not found a suitable solution, we discussed with the SEMI Commission on the chipping issue. We are searching for a cheaper solution for the manufacturers. Therefore, if you do not mind, we will put a hold on this proposal and on the current text in the Rules until the Congress 2023. We will work with the SEMI Commission on a suitable proposal for 2023. So, if you do not mind, this proposal remains on hold, and the current text of the Rules remains on hold also until we have found a better and cheaper solution for the manufacturers in 2023.

Do you have any objection to this? Thank you.

Proposal #23 from the SEMI Commission. The Executive Committee was in favour of the proposal.

We open the vote. The vote is open. The vote is closed. The proposal passed. Proposal #23 passed.

We move to Proposal #24 from the SEMI Commission. The Executive Committee was in favour of the proposal.

We open the vote, and the vote is open.

The vote is closed.

The proposal passed.

Proposal #25 from the SEMI Commission. The Executive Committee was in favour of the proposal with the revisions from the SEMI and Rules Commissions.

We vote on this proposal, and the vote is open.

The vote is closed.

The proposal passed.

Proposal #26 from the SEMI Commission. The Executive Committee was in favour of the proposal with the revisions from the SEMI and Rules Commission.

The vote is open.

The vote is closed on Proposal #26.

The proposal passed.

We now move to the Urgent decisions regarding the Rules.

Urgent Decision #1 is a proposal from the Rules Commission and the Refereeing Commission. The Executive Committee was in favour of the proposal and urgent decision. Yes. Sorry, yes.

We open the vote on Urgent Decision #1, and the vote is open.

The vote is closed.

The proposal passed.

Urgent Decision #2 is a proposal from the Executive Committee on the calendar.

We open the vote on this proposal.

The vote is open. The vote is closed.

The proposal passed.

The last urgent decision from the SEMI Commission has already been dealt with, with the relevant proposal. We have finished with the Proposals regarding the Rules.

It's time now for the photo and lunch. Please follow the FIE photographer, Augusto Bizzi, who will show you where the photo of the Congress will be taken. Then, we will have lunch. After the photo, Members of Honour should please come back here to discuss the nominations of Members of Honour to be proposed to the Congress.

Thank you very much.  
Have a very good lunch.

*Applause.*

*(Lunch)*

**Nathalie Rodriguez:** Please take your seats. We will resume the meeting, and we are now dealing with the Progress reports from the working groups.

The working groups met online several times during the year, and they established a progress report of their work. However, the work is still ongoing. There were meetings after the reports were issued, and new meetings will be held at the beginning of next year.

We believe we will be able to present to the next Congress final proposals for your consideration. Do you have any questions on this? Thank you.

I would like to inform you that Sri Lanka has arrived. Sri Lanka had given a proxy to Nepal. So, Nepal now will no longer vote for Sri Lanka. Thank you.

## 12. Decisions regarding athletes and officials from Russia and Belarus

**Nathalie Rodriguez:** We move to item #12 of the agenda, Decisions regarding athletes and officials from Russia and Belarus, and the floor is to Emmanuel Katsiadakis.

**Emmanuel Katsiadakis (MH):** So, as a preamble, let me remind you the following. The FIE is a non-governmental and autonomous organisation, and its role is to manage and rule the sport of fencing worldwide.

The FIE ethical code states that the FIE family members will work to maintain harmonious relations with the authorities of the countries of the member Federations in accordance with the principles of universality and political neutrality. The FIE family shall take all necessary measures to ensure security on the premises where the competitions are held, primarily considering the physical and moral well-being of everyone involved in this event.

The FIE Statutory aims include:

- to ensure that international competitions open to member Federations are organised with the FIE rules, and
- to establish rules and appropriate measures to protect athletes' health and prevent any abuse.

Therefore, it is the duty of the FIE Executive Committee to protect the integrity of FIE competitions and to ensure the security of athletes and participants. After the incidents that occurred in various competitions at the end of February, and following the IOC recommendation, the Executive Committee initiated, with a heavy heart, the following decision that was published on the FIE website. "On March 2nd, and following the IOC recommendation, the FIE Executive Committee decided not to invite or allow the participation of Russian and Belarusian athletes and officials in FIE competitions until further notice."

The Executive Committee's decision was not a sanction; it aimed and allowed to protect the integrity of FIE competitions and to ensure the security of all athletes and participants. As of today, the IOC recommendation is still in place. However, we all know that we will start the Olympic qualification in four months. The Olympic Games are within the jurisdiction of the IOC, and it belongs to the IOC to decide on the participation in the Games, and the qualification path is within the responsibility of the FIE to be approved by the IOC.

The Executive Committee does not want to exclude the Russian and Belarusian athletes from the Olympic qualification. Therefore, the Executive Committee unanimously decided during its meeting of 25 November 2022, to organize an online extraordinary Congress at the beginning of March 2023, to make decisions regarding the possible options for the Olympic qualification.

The Executive Committee will meet in January 2023 to establish proposals that will be submitted to the online Extraordinary Congress.

And finally, the Executive Committee unanimously submits to the Congress the following motion: "Do you accept that the Executive Committee continues with its decision of March 2, 2022, for the time being, while reviewing and reconsidering the situation in case of any new circumstances?" Thank you.

**Nathalie Rodriguez:** I assume that some Federations wish to express their opinions. In case there are a lot of Federations, we will have to make a list so that they can speak in turn.

So, for a better understanding of Congress, let me clarify once again. There will be an extraordinary virtual Congress at the beginning of March in order to discuss the Olympic qualification of the Russian and Belarusian athletes. It is a decision of the Executive Committee, which was made unanimously yesterday.

As of today, the Executive Committee unanimously submits to Congress the following motion: "Do you accept that the Executive Committee continues with its decision of March 2, 2022, for the time being, while reviewing and reconsidering the situation in case of any new circumstances?"

Please say your name if you wish to take the floor. I cannot see very well because of the lighting.

*[Remarks in the audience]*

No. First, I am going to make a list of all the Federations that want to take the floor. So, Ukraine is wishing.

**Sergii Mishchenko (UKR):** Hello. Ukraine, Sergii Mishchenko, Vice-President.

**Nathalie Rodriguez:** Yes.

**Sergii Mishchenko (UKR):** Thank you.

**Nathalie Rodriguez:** Who else would like to take the floor? Can you please say your name? I cannot see very well because of the lighting.

**Olga Kharlan (UKR):** I am sorry. Olga Kharlan, Ukrainian fencer.

**Nathalie Rodriguez:** Thank you. Your name, please, and Federation. Niger. Sweden. Ghana. Belarus. Venezuela. Russia.

Nobody else? Sorry? The USA. Great Britain. Member of Honour Peter Jacobs.

Anyone else would like to take the floor? Nobody else? Fine.

Senegal. Is that all? Yes. Finland. Nobody else? So, we will start with Ukraine.

**Sergii Mishchenko (UKR):** May I take the microphone?

**Nathalie Rodriguez:** Yes, of course.

**Sergii Mishchenko (UKR):** Your Honour Interim President, Dear Members of FIE, National Federations. First of all, I asked for a word to thank all the Federations, international organizations, and individuals who, in this difficult time for Ukraine, extended their help to our fencers. To their families during a very difficult period for Ukraine. Many thanks to FIE, many thanks to European Fencing Confederation, National Federations, and all those who extended help and provided roofs, shelter, training facilities, and the ability to travel and participate in international competitions.

Why the Ukrainian Federation and Ukrainian fencers needed this and are still in need? They needed it because of the war, which was waged against Ukraine. It is a vicious, aggressive war, and Ukrainian fencers are suffering a lot. There is no safe place in Ukraine now. Fencers who would like to train often have to break the training lessons because of the signals of the air attack warning. The places are cold because there is no electricity. And

because of all that, it is very difficult to continue any serious regular training in our country.

That's why we were fully supporting the International Olympic Committee Executive Board's recommendation regarding banning Russian and Belarusian athletes and officials from international competitions. This is a true and just decision. It is not only for the sake and because of what happened in Ukraine. It is also in the interest of the Olympic community and in accordance with the Olympic principles to be helped and to be respected. There are many arguments now that, for example, what has been proposed and implemented by the International Olympic Committee Executive Board is inefficient and is not working, but it's not true.

There are wars. Historically, there have been many wars, and during those wars, no one in the Olympic movement took such a decision. But there is a straightforward answer to it. First of all, are we happy that there are many wars, and do we want to have more wars? No. The answer is no. The question is can we do something as an Olympic community to try to stop the wars and prevent more wars? The answer is yes. And the actions which now taken by the Olympic community, by the International Olympic Committee, are a small step to prevent wars, to bring the end of the war maybe ten minutes closer to us or ten days closer to us.

The second argument is that these actions, which have already been taken, have very little effect. But I believe it is not true because, first of all, dozens of International Federations who follow the International Olympic Committee's recommendations are already a very important force in the world sport. Secondly, you probably don't even imagine how helpful it is to Ukrainian people, to Ukraine, that we feel the solidarity of the Olympic movement.

That is why I strongly urge you, ask you, appeal to you to continue with the application of the recommendations of the International Olympic Committee as it is now proposed by our Board. I believe that following this recommendation at the moment and closely monitoring the situation will help us a lot. So please keep with the recommendations of the International Olympic Committee Executive Board until the war ends, until the decision will be fully satisfying to world peace, to the Ukrainian people, and to the fencing community. Thank you.

*Applause.*

**Nathalie Rodriguez:** Ms Kharlan.

**Olga Kharlan (UKR):** Dear Olympic Fencing Family, Thank you for giving me the floor. I can be emotional, I will be short, so please let me finish. Many of you know me for many years. I am Olga Kharlan, and I am Ukrainian. I am from Ukraine. Taking the floor, I would like to thank the National Federations for your generous support provided to the national team of Ukraine. Today's life is essential for us. Your help is the true value of the Olympic solidarity and Olympic principles and actions, which our Federation is guided by in its activity to. I am here to make a voice and appeal of Ukrainian fencers and fencers from all over the world to be heard.

Athletes are the core of the Olympic-centered system and the heart of the peaceful world for sports development. What does the athlete feel coming to compete? Everyone knows that mental balance is fragile, but it is not only the key to win. For us Ukrainians, it is a key to survive; nine months of war, nine months of missile attacks, nine months of ruins of cities, civil and sports infrastructure, and the loss of sports friends and their family members. My Beijing 2018 teammate, an Olympic champion, Elena Komarova's father, was killed by this war in Mykolaiv city. Dying kids, athletes, and coaches, nine months of forced immigration, away from home, months of electricity shutdowns causing lights to go off, hitting the Internet, and even a war lockdown.

Now ask yourself a question. What is fair play in the sport today? Which Olympic values weigh more: friendship,



excellence, respect, or friendship to those who keep silent and shelter their tyrant head at state and public events? Do we have to pay respect to them? Do we have to let show them excellence in competitions to promote the power of terrorist state recognized so by international institutions such as NATO and the European Union Council? What is the highest value, the right to live or the right to compete? When the Ukrainians were standing it all, where were the Russian and Belarusian athletes all these nine months, and what did they do while we felt touching support from all the Europe and the world fencing family and friends?

Nine months ago, Russia violated the Olympic Truce, not for the first time, and Belarus also by providing its borders for the Russian invasion of Ukraine. Does the Olympic Charter have a selective approach to some countries or personal responsibility? I think not.

The quote that Russian and Belarusian athletes are not responsible for their government does not help when the social polls show that 80% of the Russian Federation citizens support their government and the war as a tool, as genocide in Ukraine. Did you see what Russian Federation did in Bucha, Izyum, Irpin, Mariupol, and Mykolaiv, my motherland? Will you be able to shake hands with the Russian Federation or Belarusian athletes, then?

As you may know, many Russian and Belarusian athletes are army or police, or state border service contractors. They are still there for all these nine months. What will happen if they receive an order? Mr. Pozdnyakov, the Chairman of the Russian Olympic Committee and Olympic champion fencer, is a colonel of the Russian army that is shelling every day my native city Mykolaiv. Sofya Velikaya is a ruling party athlete and Putin's representative. It is not a secret that Russian athletes are the propaganda tools for whitening and keeping the face of Russian government crimes. Should we, the fencing world, provide the stage for this face? I think not. Fencing is a noble sport based on respect and fair play, observing its history's rules and Olympic values.

Together we are able to stop the aggressors' countries' politics and their state propaganda through the sport of international stages. I think, yes. Sport is a place for people who bring peace, unconditional peace without twisted values. Stand with Ukraine. Thank you for your attention.

*Applause.*

**Nathalie Rodriguez:** Niger.

**Halilou Sani (NIG):** Hello. Thank you for giving me the floor. Really, I understand everything that happens in the world. Niger is also a victim. I have the right to remind you that in the Sahel, many people are killed. In Yemen, many people are killed. In Eritrea, many people are killed. In Ethiopia, many more people are killed. Do you think we should bring political issues into this room? If so, then let's do it. Thanks.

*Applause.*

**Nathalie Rodriguez:** Sweden.

**Otto Drakenberg (SWE):** Sweden thinks it is a very wise idea of the Executive Committee to postpone the decision regarding athletes and officials from Russia and Belorussia. And we insist that once the postponement has been done, the decision whether to include again or continue to exclude these athletes should be taken either by the Executive Committee or by an extraordinary physical Congress, the reason being that the extraordinary virtual Congress would not be the best and most democratic way of taking this kind of decision. Thank you.

*Applause.*

**Nathalie Rodriguez:** Thank you. Ghana.

**Mohammed Mahadi (GHA):** Dear Delegates, I would like to call attention to a few things. I would recall in one of the series of Olympic Games, there was a situation whereby an Algerian fencer was banned for ten years for refusing to shake hands with one of our brothers, who is also, I think, an Israeli fencer. Sorry, Israeli judoka. He was banned because the IOC, sorry, the IJF, that is, the International Judo Federation, said that his actions were introducing politics into sports. That issue was taken to the Court of Arbitration for Sport (CAS).

Therefore, if today we are also turning the line from politics to sports, we are undermining the autonomy of sports. The autonomy of sports separates politics from sports. In any decision we are going to take, we should stick to the autonomy of sports, which is the pride and the milestone we have achieved as an organisation.

I think it is about time to call the Russian and Belarusian fencers and officials back to the stage, to come and compete as a family because we are not politicians, we do not influence, and we do not have any influence in politics. And I want to remind you of the situation that happened between CONI and the Ministry of Youth and Sports of Italy. I just read this article regarding the case with the law they are introducing that nearly led to Italy being banned from Tokyo 2020. But it was clear that the Minister mentioned that sports and politics are definitely two different things. So, my humble appeal is to let's get our athletes back because we cannot manage it if we keep them longer outside the competition arena; we will end up introducing the situation that happened in IJF. My humble appeal is, let's get them back. Thank you.

*Applause.*

**Nathalie Rodriguez:** Belarus.

**Vitali Sokolovski (BLR):** Dear President, Dear Officials, and Members of the International Fencing Federation. On behalf of the Belarusian Fencing Federation, let me convey the official position of our Federation on the current situation in Ukraine, as well as on the participation of Belarusian athletes and officials in events under the auspices of the FIE.

The Belarusian Fencing Federation is a public organisation whose task is exclusively to develop and popularize fencing. Members and officials of our Federation do not take any part in political decisions and do not have the opportunity to influence them in any way. We do not support war anywhere and in any form. Athletes of Belarus, coaches, and the entire fencing community of our country want just one thing, peace and unity in the world. We have never had and do not have any conflict with the Ukrainian Fencing Federation, Ukrainian athletes, coaches, and officials, as well as with other countries in the world. On the contrary, we respect all these people very much and wish the military conflict on their territory to end as soon as possible.

There is no doubt that people in Ukraine should be given all kinds of help. Still, the question remains, how does the non-participation of Belarusian athletes contribute to helping the Ukrainian people? The answer is that the isolation of the Belarusian and Russian fencers does not contribute to this assistance in any way. I think everyone has been convinced for more than nine months that the isolation of Belarusian and Russian athletes in no way affected the events taking place in Ukraine.

The International Olympic Committee President Thomas Bach made a comment during a keynote speech at the

Oceania National Olympic Committees' General Assembly in Fiji. "We will only sanction those people that are responsible for something. We will not sanction a National Olympic Committee for the actions of its government as long as the NOCs' leading individuals do not support their actions. None of you, none of you should be held responsible for the actions of your government."

We fully and completely share this position and do not consider it right in this situation to isolate innocent Belarusian fencers, coaches, and officials solely on a national basis. We believe that any decision on non-admission should be personalized and imposed taking into account the actions committed by a particular person. Once again, I would like to emphasize the fact that Belarusian athletes, coaches, and the Fencing Federation in no way influence and will not be able to influence political and military issues. Just try to answer the questions for yourself. Do you seriously consider it fair and right to apply any sanctions to athletes and coaches solely on a national basis, only because they were born in Belarus, live in Belarus, or abroad, but have a Belarusian passport?

We urge the entire international fencing community to unite and truly remain an FIE family in the most difficult times. It is necessary to prevent the incitement of discord, anger, and hatred within the sports community and be an example of solidarity and tolerance for politicians in all countries. Of course, we will respect any decision you make. However, I urge all of you not to mix sports with politics but to make decisions solely in the interests of the development of world fencing. Thank you for your attention.

*Applause.*

**Nathalie Rodriguez:** Venezuela.

**Francisco Rafael Marín Alvarez (VEN):** Good afternoon to the Executive Committee and to all Brother Federations. I want to reflect on what my previous colleagues have said about not mixing politics with sports. Venezuela has been economically isolated and blocked for more than four years, and we have experienced firsthand discrimination and xenophobia. Our athletes and coaches have stopped attending competitions because the governments of other countries have denied us visas, even though the Federations have always been ready to help us. But for being a small country in South America, we go unnoticed. We have experienced what it means to want to attend competitions and not be able to participate in them due to political problems.

Every April 6th is celebrated as the International Day of Sport for Development and Peace. Hopefully, on April 6th of next year, we can all celebrate that day for sport and peace, with the participation of athletes and officials from Russia and Belarus, because we want to change the world. Let's do it from here, and let's demonstrate unity. Nobody agrees with wars. We also suffered power outages. Our kids also have a hard time training. We also have feeding problems. We also have issues that sometimes no one knows about. The comrade from Africa said it. There are military interventions in many parts of the world, but we are not in the UN. We are at the International Fencing Federation, and here we have to discuss sport and unity and send the world a message that we can contribute to peace through sport. If we can contribute to the brotherhood, the teammates from South Africa are a great example of how violence can be changed with a game of rugby. They can teach us a lesson about that.

So, from Venezuela, we call on everyone to unite, to solidarity, to teamwork. I repeat, hopefully, on April 6th, we can all reject any kind of war and always open our arms to peace. But I repeat, nobody, nobody remembered that Venezuela has been blocked for four years, that Venezuela has been facing xenophobia for four years, that our athletes have been attacked at airports, that I, as a Federation, have been attacked at airports due to our problems with migration, due to our displacement problems.

So, we all have to deal with world problems. Politics is not the way to solve it in this space because we are not the ones who make the political decisions of our countries. We make sports decisions, and I invite you to make a decision for the sport.

I express my solidarity with the Ukrainian comrades; we have experienced it. We have experienced those power outages also under another style, but we have lived through them. We have experienced discrimination; we have also experienced attacks.

We are going to work together as we want to change the world. Let's start the change from here. Let's change it with sport and send a message that it is possible to work in peace and unity. In the same way, we will abide by the decisions issued by the International Olympic Committee, which is our rector, and we owe it to it.

Thanks to the fellow interpreters for carrying my voice, thanks to the Executive Committee for giving me the right to speak. We want to make peace. Let's do it together. Thanks.

*Applause.*

**Nathalie Rodriguez:** Russia.

**Ilgar Mamedov (RUS):** Dear Friends, Dear Colleagues, Dear Nathalie. In addition to the COVID test, it is necessary to conduct a test for mental sanity. The behaviour of some Members of Congress is unacceptable. If you remember, Mr. Khrushchev, from the Soviet Union, made this gesture, and he was a leader. We must respect each other, even if we have a difficult time here in the FIE. The FIE Congress is a chance to elevate global understanding about the threat posed by the division of the fencing community. This situation is the most dangerous crisis our fencing family has ever faced.

Olga Kharlan is a young athlete. And if you know, I was born in Baku, and I moved from Baku to Moscow because we had a war between Azerbaijan and Armenia. Here is the President of the Armenian Fencing Federation, and we have very good relations, even though we had a war in the 90s as well as two years ago. These are human relations; we must respect each other, and we are a sports family. We never talk about politics because we are not politicians.

No one has ever connected American athletes with their country's military operations. What is the difference between American athletes from the USA and athletes from Russia? Or, you do not know the history? No one urged them to protest against the decisions of their State Department and White House.

How does the non-participation of Russian sportsmen help Ukraine athletes? If politicians cannot do something to make peace, we, as a sports family, must do something. Therefore, I want to make an offer to the Ukrainian Fencing Federation. I would like to provide training and participation of their teams in competitions in the next six months. I understand that it is difficult directly, but through any intermediary, if it is possible, I can organise everything for your team. I already wanted to arrange this before the World Championships in Cairo, but unfortunately, it was dangerous for the Ukrainian side.

Our athletes have already suffered if you know. For example, the women's sabre team was the first in the ranking. Now, I just checked it on the FIE website; they have 43rd or 42nd place in the ranking. It means one more competition, and we no longer exist in the fencing. And it was the number-one team after the Olympic Games. What else can we do to not participate in competitions?

Six months ago, we had a meeting here in Lausanne when I arrived for the court hearing. We had with Manolis Katsiadakis a court meeting. It was not a real court hearing but a meeting to analyze the situation, find a solution, and a compromise. It was the first of June, and I told Manolis, "You always say that all athletes are your kids." And that was International Children's Day. "Let our kids participate in competitions." Because what I told you before, non-participation does not stop the war. Unfortunately, unfortunately does not stop. They have their plans, and we have our plans to be in the fencing family. Dear Delegates, we all remember the address of Mr. Thomas Bach, "Give peace a chance." Only sport can help us to unite people. Only through a peaceful competition, we can show the world our unity. Only if sports remain neutral, if sports stay out of politics, we have a chance to build a bright and strong future. Together. Together with you, my colleagues, thank you very much.

*Applause.*

**Nathalie Rodriguez:** USA.

**Samuel Cheris (USA, MH):** Mr. President, Madam CEO, Members of the Bureau, Members of the Executive Committee, Congressists. The Russian-Belarusian war has not only attacked the country of Ukraine, has not only attacked the armed forces of Ukraine, but it also attacked Ukraine's civilian population, is has attacked the athletes of Ukraine. How can we permit a country that is preventing civilian life, including the training of athletes, to come in and say we are entitled to compete because we are peaceful fencers when our country is demoralizing the athletes of another country and preventing them from training? Many of the members of the Russian and Belarusian teams are members and officers of their military. How can we allow those who personally are part of the aggression to be permitted to compete as if they were not complicit? Have they resigned from their military commissions? Have they protested against the war?

It was talked about the U.S. protest, yes. I mean, U.S. athletes, if they do not like what their government is doing, they protest. Have the Russian athletes protested? If this was merely a philosophical issue, why has a representative of the foundation for the Future of Russian Fencing been going around the world, giving out money? Allegedly to administrators to be able to attend competitions and meetings, but with the quid pro quo, here is the speech I want you to give at the Congress, here is the vote I want you to take, and here is the money that I have provided you. Will it help? Will it help to stop them from competing? I do not know. The FIE and the IOC banned South Africa from competing because of apartheid and isolated them from the sporting community. And it was one of the elements that finally caused the apartheid to end. So yes, it can have an effect. We can vote with our conscience and say if you want to join the family, be part of the family, and do not be going around killing the family. Thank you.

*Applause.*

**Nathalie Rodriguez:** Peter Jacobs.

**Peter Jacobs (GBR, MH):** Mr. Interim President, Members of the Executive Committee, Fencing Friends. I want to put a stiff, slightly different slant on what I want to say. I want to talk about the IOC and our relationship with it because we are indeed an independent sports organisation. But we are also affiliated and members of the IOC. Do not forget that our Statutes state right at the beginning that any new Federation must be accredited with their National Olympic Committee as the sole representatives of fencing in their country.

Why do I stand up and speak in front of you? I think because maybe, in some vanity, I am the most senior FIE person here. I was first elected to a Commission 45 years ago. I have been in the Executive for 24 years and

the Treasurer; and also fenced into the Olympics and been accredited to ten others. So, I hope that my advice may, by some, be taken as useful.

And what do I see as the first priority, therefore, of the FIE? It is to be an Olympic sport. And what do I see as our second priority? To remain an Olympic sport. And what do I see as our third priority? It is not to do anything that endangers our position with the IOC and endangers our being an Olympic sport. End of story, because every one of your Federations also relies on the IOC directly or indirectly.

Not only does the FIE finances are underwritten by the IOC with its money from each Games every four years, and that is the most stable support that the FIE has. There may well be sponsors at the moment who support fencing, and there may be in the future. But who, in the end, would want to spend their energies and money supporting a sport that is not an Olympic sport and is not that well known? Who will find sponsors, and who will support the Federations? Each of your Federations relies on your National Olympic Committee, and it relies on your sport, our sport, fencing, being an Olympic sport and therefore having standing and status, and attraction. Do not endanger it.

Thomas Bach said in March that he wanted every International Olympic Federation to support the IOC in its current activities, and no more, and no less. I understand that the IOC has said exactly the same thing to the FIE in the last few weeks. So why would we attempt to risk committing a fencing suicide by going against the IOC now? Rather than supporting the Executive Committee in their decision to continue supporting the IOC as they wish, at least until March. And personally, I hope that then as well, we will continue to support the IOC in whatever they do, whether it is to maintain the current situation or to welcome the Russians and Belarusians back into fencing. Thank you very much.

*Applause.*

**Nathalie Rodriguez:** Senegal.

**Mbagnick Ndiaye (SEN):** Thank you so much. Mr. Interim President, Madam Executive Director of the FIE, Ladies and Gentlemen Members of the Executive Committee, Ladies and Gentlemen Delegates, Dear Congressists, The problem opposing us and that concerns us today is a problem of extreme sensitivity. It is speaking or making decisions according to a situation that is born out of politics. The war in Ukraine was started by politicians and not by sportsmen. This war has terrible consequences. Athletes cannot train. In Africa, the consequences are disastrous for the populations. The cost of living has increased, like it or not.

But pose here, today, this problem of exclusion of athletes who were not at the root of this situation, athletes who are strangers to the current events, insisting on their exclusion today in 2022, is for us, who have been here for several years, a novelty.

When Afghanistan was invaded, did you make the decision to punish the invader? When Syria was invaded, did we make the decision to punish the invader? When Armenia and Azerbaijan were in conflict, did we care who was wrong, who invaded, and who did not invade? I think we are mixing two domains: politics and sports. Our goal must be to defend sports so that war does not create hatred between athletes. The sportsmen must be at the base of the reconciliation, after the catastrophes of the political decisions made.

Yes, there is war, and its consequences, on athletes but also on populations. That is what I want to say. This is why we must try to find a solution to this problem; it is not by excluding the athletes that we will find the best

solution. I honestly think as a President of a Federation and not as a Member of an Executive Committee, I think we have to know how to be reasonable. To know how to be reasonable is to ensure that we try to find the appropriate solutions to this problem. By doing what? By following the decision of the FIE Executive Committee, which is looking for ways and means, to ensure that our family is united, that our family goes in the direction wanted by the athletes and not in the direction wanted by the politicians. This is why, as a free and independent federation, free and independent, free and independent, we follow the decision of the Executive Committee of the International Federation.

Certainly, we are not here to see the fencing family divided into two, those who are for and those who are against. Wars will always take place in this world. People will always take positions, dramatic ones for some. Are we going to spend all our time at the International Federation saying, yes, there is war here, we sanction, yes, there is war here, we sanction, yes, there is war here, we sanction? Why did not we do it when Afghanistan was invaded? Why did not you, you from the FIE?

And in Africa, these undeclared invasions, these invasions that are not officially declared, harm us by creating prejudice. Why do not you look for these European countries that are invading us, these European countries, which are creating problems for us Africans?

*Applause.*

Why do not you want to talk about it? And because a country has invaded another country in Europe, in Europe, in Europe, you raise to say no, no, and no. Why do not you say it for Africa? Why, my dear delegates, do you not say it for Africa? Why? Do you want to divide us? Because on one side, there are those who suffer, and on the other side, there are those who invade.

I think that Senegal, as an independent country, a responsible country, follows the decision of the Committee and asks all those who have the same thought, orientation, and vision to follow the Executive Committee of the International Federation. Thank you.

*Applause.*

**Nathalie Rodriguez:** Finland.

**Joonas Lyytinen (FIN):** Mr. President, Dear Friends, It is very true that the international community has failed many times before, it has made mistakes, and it has not made decisions when decisions should have been made, especially related to Africa, but also to other places, and Europe has had a big part in this. But the way to respond to past mistakes is not to make the same mistakes again and fail again in the same way we have failed in the past. We have heard many pleas about not mixing sports and politics in this room. I would remind everybody that in Russia, President Putin is parading the Olympic medalists in pro-war rallies, and Mr. Pozdnyakov, who is the President of the National Committee of Russia, is publicly supporting the war.

So, we may ask, who is the party mixing sports and politics here? Is it us or the parties guilty of starting this war of aggression? It is also true that Russian athletes and officials are victims. They are victims because they cannot participate in the sport they love, and they have trained for years. They are victims like the million young men who have fled Russia in order not to be mobilized and sent to fight an illegal war in Ukraine and die. They are victims like the 100,000 Russian men who have already been killed and wounded in the war in Ukraine.



But they are not victims of the decisions we have made, or the IOC has made, or the international community has made, or the United States has made, or any other party you might name. They are the victims of the decisions made by the Russian and Belarusian governments and not victims of our decisions. We have here pleas that we have to be independent, and we have to make our own decisions and not mix sports with politics. I would like to remind everybody that by excluding the Russian and Belarusian athletes for at least until March, we are not following the orders of any other external party. We are following the recommendation of the International Olympic Committee, which is the highest governing body of sports in the world. So, we, as a sports community, are making these decisions following the recommendation of the IOC. I would strongly recommend that we follow the IOC and vote for the proposition made by the Executive Committee to continue the exclusion until March and make the decision then in an extraordinary Executive Committee. Thank you very much.

*Applause.*

**Nathalie Rodriguez:** So, the motion that is presented to the Congress, I repeat, is the following: “Do you accept that the Executive Committee continues with its decision of 2nd March, 2022, for the time being, while reviewing and reconsidering the situation in case of any new circumstances?”

We are going to open the vote on this motion.

The vote is open.

The vote is closed.

*Applause.*

The motion of the Executive Committee passed.

**Nathalie Rodriguez:** The decisions were already read. We said that the Executive Committee does not want to exclude the Russian and Belarusian athletes from the Olympic qualification. Therefore, the Executive Committee unanimously decided during its meeting on 25 November, 2022, to organise an extraordinary virtual Congress at the beginning of March 2023 to make decisions regarding the possible options for the Olympic qualification. The Executive Committee will meet in January 2023 to establish proposals that will be submitted to the extraordinary Congress.

And the decision that you have just voted is that you accept that the Executive Committee continues with its decision of 2nd March, 2022, for the time being, while reviewing and reconsidering the situation in case of any new circumstances.

*Applause.*

The next part of the Congress will be the awards for items #13, #14, and #15, but meanwhile, there will a coffee break.

*(Coffee Break)*



## 13. Nominations of Members of Honour

**Nathalie Rodriguez:** Please take your seats. We are moving to the last parts of Congress. Please take your seats.

We will start the awards part with some music.

*[Music is played]*

This music belongs to the FIE. If you wish to have it, you are welcome. We will provide it to you. It has been composed as a tribute to all fencers in the world.

*Applause.*

Item #13 is Nomination of the Members of Honour. The floor is to Emmanuel Katsiadakis.

**Emmanuel Katsiadakis (MH):** Dear Friends, following the proposition of the FIE Executive Board, the Honours Commission has met and unanimously approved the following candidates for the title of Member of Honour. Mr. Jacek Bierkowski and Mr. Victor Sergio Groupierre.

*[Exclamations in the audience]*

*Applause.*

**Nathalie Rodriguez:** Jacek and Victor, please come. I know I had to lie to you, Jacek, to have you here. I apologize for this lie, but it was for the good of fencing.

*[Awards are given]*

*Applause.*

## 13. 2022 Fair-Play Trophy

**Nathalie Rodriguez:** The next item is the 2022 Fair-Play Trophy award. Based on the proposal of the Fair-Play Council, the Executive Committee has nominated Sheila Liliana Tejeda of Mexico and Zsombor Keszthelyi from Hungary.

*Applause.*

*[Awards are given]*

*Applause.*

## 14. Winners of the 2022 official rankings and Nations Cups

**Nathalie Rodriguez:** For the next item, Winners of the official rankings and of the Nations Cups 2022, I request all members of the Executive Committee to move up to the award wall to present the medals to the athletes and teams. All the members of the Executive Committee, please, there are a lot of people who will receive medals. By the way, I would like to congratulate Yuki Ota, whose birthday was yesterday.

*Applause.*

### Individual Junior Rankings

Women's Épée – Hadley Husisian from the USA

*Applause.*

Men's Épée – Zsombor Keszthelyi from Hungary

*Applause.*

**Nathalie Rodriguez:** The next athlete who should prepare is Lauren Scruggs, the USA.

Women's Foil – Lauren Scruggs from the USA

*Applause.*

Men's Foil – Chase Emmer from the USA

*Applause.*

Women's Sabre – Sugar Katinka Battai from Hungary

Men's Sabre – Colin Heathcock who is now from the USA (Note: he was fencing for Germany when he won the ranking)

*Applause.*

### Junior Team Ranking Winners

**Nathalie Rodriguez:** Now the Junior Teams.

Women's Épée – Israel

*Applause.*

Men's Épée – Egypt

*Applause.*

Women's Foil – USA

*Applause.*

Men's Foil – Italy  
*Applause.*

Women's Sabre – France  
*Applause.*

Men's Sabre – Egypt  
*Applause.*

## Individual Senior Rankings

**Nathalie Rodriguez:** Now the Individual Senior Rankings.

Women's Épée – Injeong Choi from Korea  
*Applause.*

Men's Épée – Romain Cannone from France  
*Applause.*

Women's Foil – Lee Kiefer from the USA  
*Applause.*

Men's Foil – Tommaso Marini from Italy  
*Applause.*

Women's Sabre – Anna Bashta from Azerbaijan  
*Applause.*

Men's Sabre – Áron Szilágyi from Hungary

**Nathalie Rodriguez:** Áron is not here. Can we ask the Federation to receive his medal?  
*Applause.*

## Senior Team Ranking Winners

**Nathalie Rodriguez:** Now the Senior Teams.

Women's Épée – Korea  
*Applause.*

Men's Épée – France  
*Applause.*

Women's Foil – Italy  
*Applause.*

Men's Foil – Italy

*Applause.*

Women's Sabre – France

*Applause.*

Men's Sabre – Korea

*Applause.*

## **Nations Grand Prix**

**Nathalie Rodriguez:** The winner of the Grand Prix of the Nations for Juniors, Cadets, and Veterans is the USA.

USA, please come to receive the three medals.

*Applause.*

**Nathalie Rodriguez:** The Senior Grand Prix of the Nations goes to France.

*Applause.*

Thank you very much.

## 15. Any other business

**Nathalie Rodriguez:** Thank you very much. So, we move to the last item on the agenda, which is the Various Items.

For the Second item, I will ask Jacek Bierkowski to make a presentation on the preparations for the Olympic Games. But with the First item, I will deal myself. I must admit, and I hate it, not being perfect. I have to tell you that I just forgot – it is entirely my fault – to submit to your approval the 2021 Congress Report, which you received, and which is posted on our website, but we did not vote on it. It is entirely my fault. So, if you agree, I would like you to vote on that item, in order not to forget it. So, I will open the vote on the 2021 Congress Report, which you had received, and which is posted on our website.

The vote is open.

The vote is closed.

Thank you very much for approving it, and my apologies.

**Nathalie Rodriguez:** Jacek, will you please come to the tribune? Jacek Bierkowski and Dieter Lammer are the two technical delegates for the Olympic Games, and they wanted to update you on the ongoing preparations for the 2024 Olympic Games in Paris.

**Jacek Bierkowski (POL):** Firstly, I would like to say thank you to the Honour Commission for this title. It was a big surprise for me. Thank you.

*Applause.*

My friend Dieter Lammer and I would like to show you the situation of the preparation for the Olympic Games in Paris 2024.

Everybody remembers the Grand Palais, one of the most beautiful buildings in Paris, and this is the building we will use during our Olympic Games in Paris. You also remember that this building hosted the Senior World Championship in 2010, then we celebrated our 100th anniversary in 2013 and 105th anniversary in 2018. This is our visit in September of this year. The Grand Palais looks like this.

*[Exclamations in the audience]*

Not too bad, not too bad. Yes.

*(Laughter)*

**Nathalie Rodriguez:** It will be better.

**Jacek Bierkowski (POL):** This gentleman, maybe this is Dieter.

*(Laughter)*

Now back to the serious topic. This is the renovation of the Grand Palais, which is a huge, huge project. The cost

of the renovation is €500 million, and it is a huge money. Of course, the cost of the Olympic Games organised in France is just €7.6 billion. They will demolish everything, but everything must stay quite the same as many years before.

The audience of this palace is 8000 seats, including the wheelchair seats and dimensions of the field of play. This is a place where we should install the platform with a four-colored piste, and the center final piste is 46 meters in length and 60 meters wide. This is the way how the site is looking at this moment, and I'd like to ask Dieter to explain how everything should be positioned.

**Dieter Lammer:** Okay. Highlighted in blue, you see the venue; in the middle, you see the four-colored piste and the podium piste. On the right side is the entrance; below, you see the warmup area.

On the left side is the waiting area for the boxes. And in blue, and on the left side of the field of play, you see the final warmup area and the call room. The warmup area is on the first floor of this venue. Maybe we can see another plan also, but this is the construction right now.

**Jacek Bierkowski (POL):** The construction of the Grand Palais does not easily allow us to describe the competition's setup. The blue one above shows the completed condition of the call room, and the referees and the fencers come down by the stairs to the field of play – next slide.

**Dieter Lammer:** Here, you see the competition schedule. As usual, we start with three days of individual competitions, followed by the team competitions, as you see here on the screen. This schedule is most similar to Tokyo.

**Jacek Bierkowski (POL):** You can see the men's and women's weapons rotations, every day we change, it is absolutely the same condition. This is the Olympic village. I am sorry, I do not use this laser because it is forbidden in Europe. The Olympic village is a huge area that is in the north of Paris. The name of this district is Saint-Denis. The blue area you see is the dining hall, and this part is the training zone. Okay, you can see the Polyclinic, the main bus station, etc. Everything is there. The two buildings in blue are our training hall. Dieter will show you.

**Dieter Lammer:** Yes. This is the training hall until now. The training halls are located in two old cinemas. We have two training venues. Each training venue has eight pistes, and we will have to share the pistes for a few sessions with Modern Pentathlon. But in general, I think these venues are not too far for the athletes and for the coaches because they are located inside the Olympic village.

**Jacek Bierkowski (POL):** The size is also sufficient. Both studios, Studio A and Studio B are the same size; they are 432 square meters together. The repair table and the toilets should also be near these studios, and by the walls should be the benches for the coaches. Dieter is preparing a schedule for the training, so the pentathlon athletes can also use it. One more piece of information, please. The opening of the hall is scheduled for the 20th of July.

## Location and the distance.

The Grand Palais is situated exactly in the center of Paris. It is close to Champs-Élysées, Place de la Concorde, and the Alexandre III Bridge, easily reachable by walk. It's a maximum of three minutes from the metro station named École-Militaire. Not too far from Franklin Roosevelt. It's a very beautiful place, as you know. Please show the next slide. The Olympic village is not far from Paris, and it is about 15 kilometers from Grand Palais, 35

minutes by bus or minibuses. The Organizing Committee, like in Tokyo, like in London, is preparing a special lane, an Olympic lane on the street, on the road to be used by the minibuses and Olympic buses without traffic. So, we hope it will not take much time to get from the Olympic village to Grand Palais.

For your information, the ITOs, delegates of the SEMI, the Medical, of the Refereeing Commissions, the Technical Commission delegation, also the FIE family will be staying at the same hotel, which is about two kilometers walk away from Grand Palais. It takes a maximum of twenty minutes to walk, and we do not need to use any local transportation. It is a very nice location, and it's very close to our venue.

**Dieter Lammer:** The current planning for the test event will be held in the Grand Palais on 9-10th of August next year. The test event will include individual women's foil, individual men's épée, and team women's sabre. As you can see, it is very close to the end of the World Championship, but we have no other possibilities to host this test event at this stage.

**Jacek Bierkowski (POL):** You see the names of the representatives of the FIE. It is Madam Nathalie Rodriguez, our Chief Executive Officer, Dieter Lammer, our Technical Delegate, the FIE Technical and Sports Director, and me. And finally, the view of Paris. If you have any questions related to the preparation of the site, we are responsible for helping you to answer any of the questions.

*Applause.*

**Nathalie Rodriguez:** Thank you very much. Thank you. Before the Interim President closes the Congress, I would like to make two remarks. First, I would like to thank our translators today for their wonderful job.

*Applause.*

And I would like to make a special comment on the personnel of the FIE, who have supported the fencing family for the past challenging years during the COVID. They have been fantastic; without their support, I think it would have been very difficult. And I want to tell them from the bottom of my heart, thank you very much.

*Applause.*

And the floor is to the Interim President.

**Emmanuel Katsiadakis (MH):** Thank you, Nathalie. Dear Congressists, I would like to thank you very much for your participation in this Congress, historic Congress, because it was the 100th Congress in our history. I think it was successful, and a big part of this job belongs to you, for which I would like to thank you wholeheartedly. Also, I would like to thank the Executive Committee for their help with everything. I will go to thank our CEO with her heart in the headquarters, in our work, and the Sports Director. And, of course, all the staff who worked hard for this successful Congress. Again, I thank you very much for your participation and enjoy the rest of the night. Thank you.

*Applause.*

**Nathalie Rodriguez:** Please leave your voting boxes on the table. For tonight, do not forget to bring your accreditation.



FILE







# 2023 Online Extraordinary Congress

10<sup>TH</sup> MARCH 2023

## **CONTENTS**

<b>Contents</b>	<b>02</b>
<b>Attendance</b>	<b>03</b>
<b>Federations present or represented</b>	<b>04</b>
<b>Agenda</b>	<b>09</b>
<b>Validation of attendance and proxies</b>	<b>10</b>
<b>Address of the FIE Interim President</b>	<b>28</b>
<b>Decisions regarding athletes and officials from Russia and Belarus</b>	<b>32</b>

## Attendance

The meeting opened at 13:00 pm.

### Members of the Bureau:

Emmanuel KATSIADAKIS (GRE, MH)  
Ferial Nadira SALHI (ALG)  
Ana Irene DELGADO GUERRA (PAN)  
Abdelmoneim ELHUSSEINY (EGY)  
Erika AZE (LAT)

**Interim President**  
**Secretary-Treasurer**  
**Vice-President**  
**Vice-President**  
**Vice-President**

### Members of the Executive Committee:

Donald ANTHONY JR (USA)  
Paolo AZZI (ITA)  
Bruno GARES (FRA)  
Vadym GUTTSAIT (UKR)  
Velichka HRISTEVA (BUL)  
Novak PEROVIC (RSA)  
Oleg PESKOV (KAZ)  
Yuki OTA (JPN)

### Presidents of the Confederations:

Giorgio SCARSO (ITA)  
Helen SMITH (MH, AUS)  
Engr. Sheikh Salem Sultan S. AL QASIMI (UAE)  
Mbagnick NDIAYE (SEN)  
Vitaly LOGVIN (MEX)

**President of the European Confederation**  
**President of the Oceanian Confederation**  
**President of the Asian Confederation**  
**President of the African Confederation**  
**President of the Pan-American Confederation**

Ruben LIMARDO (VEN)

**President of the Athletes' Commission**

Nathalie Rodriguez (M.-H.)  
Dieter LAMMER

**CEO**  
**Technical and Sports Director**

## Federations present or represented

<b>AFGHANISTAN</b>	Represented by Kazakhstan	
<b>ALGERIA</b>	RAOUF SALIM BERNAOUI EL HOUSSINE AMEZIANE ISLAM BILEL HADI	Voting Delegate
<b>ANGOLA</b>	MEVEN PEREIRA	Voting Delegate
<b>ANTIGUA AND BARBUDA</b>	ILEATHEA CABRAL	Voting Delegate
<b>ARGENTINA</b>	VICTOR SERGIO GROUPIERRE	Voting Delegate
<b>ARMENIA</b>	ARMEN GRIGORYAN NATALIA BUNATYAN	Voting Delegate
<b>ARUBA</b>	MIGALDA JANSEN	Voting Delegate
<b>AMERICAN SAMOA</b>	IRENE KANE	Voting Delegate
<b>AUSTRALIA</b>	VINCENT ELIAS	Voting Delegate
<b>AUSTRIA</b>	Represented by Germany	
<b>AZERBAIJAN</b>	VASIF MAMMADOV	Voting Delegate
<b>BAHAMAS</b>	Represented by Guyana	
<b>BARBADOS</b>	Represented by Venezuela	
<b>BELGIUM</b>	PIET WAUTERS	Voting Delegate
<b>BELIZE</b>	Represented by Costa Rica	
<b>BENIN</b>	TAMEGNON JACQUES OKOUMASSOUN HYPOLITE ATIMBOSSOU	Voting Delegate
<b>BELARUS</b>	VITALI SOKOLOVSKI NATALIYA TSERAKHAVA	Voting Delegate
<b>BOLIVIA</b>	VIVIANA CHACÓN URDININEA	Voting Delegate
<b>BOTSWANA</b>	MANDLENKOSI MASUKU	Voting Delegate
<b>BRAZIL</b>	ARNO PÉRIILLIER SCHNEIDER	Voting Delegate
<b>BAHRAIN</b>	SALEH FARHAN	Voting Delegate
<b>BRUNEI</b>	NASHRIQ MOKSIN	Voting Delegate
<b>BULGARIA</b>	VELICHKA HRISTEVA	Voting Delegate
<b>BURKINA FASO</b>	DJIBRIL ZEB HYACINTHE DIARRA	Voting Delegate
<b>CAMBODIA</b>	ANG SOK	Voting Delegate
<b>CANADA</b>	YANN BERNARD DAVID HOWES	Voting Delegate
<b>CHILE</b>	BARBARA BLUMEL	Voting Delegate
<b>CHINA</b>	HAIBIN WANG SHENG LEI ZHIGANG HOU	Voting Delegate
<b>CYPRUS</b>	Represented by Greece	
<b>IVORY COAST</b>	ZADI THÉODORE GOGOUA	Voting Delegate
<b>CAMEROUN</b>	DIEUDONNÉ MARCEL AMOUGOU NGUINA	Voting Delegate

<b>CONGO DEMOCRATIC REPUBLIC</b>	MICHEL MAUNZA PITCHOU BOLENGE	Voting Delegate
<b>COLOMBIA</b>	MARIANA VILA CARVAJALFCE	Voting Delegate
<b>CAPE VERDE</b>	MARIA RAMOS SILVA	Voting Delegate
<b>COSTA RICA</b>	LUIS ALBERTO CRUZ MELENDEZ ALBERTO CRUZ GARCIA	Voting Delegate
<b>CROATIA</b>	ANTONIO TRCIN IRENA SULJIC	Voting Delegate
<b>CUBA</b>	ALHJADIS BANDERA MIRANDA	Voting Delegate
<b>CZECH REPUBLIC</b>	OLDRICH KUBISTA	Voting Delegate
<b>DENMARK</b>	JAN JENSEN	Voting Delegate
<b>DOMINICA</b>	CODY MORRIS	Voting Delegate
<b>DOMINICAN REPUBLIC</b>	LUIS BERNARDO	Voting Delegate
<b>ECUADOR</b>	LORENA ARROYO	Voting Delegate
<b>EGYPT</b>	ABDELMONEIM ELHUSSEINY	Voting Delegate
<b>EL SALVADOR</b>	JUAN GOMEZ MELISSA ALVARENGA	Voting Delegate
<b>SPAIN</b>	JOSE LUIS ABAJO GOMEZ ANTONIO GARCIA HERNANDEZ	Voting Delegate
<b>ESTONIA</b>	AIVAR PAALBERG	Voting Delegate
<b>FINLAND</b>	JOONAS LYYTINEN VARPU WIENS	Voting Delegate
<b>FRANCE</b>	BRUNO GARES SYLVIE LE MAUX	Voting Delegate
<b>GREAT BRITAIN</b>	HILARY PHILBIN GEORGINA USHER PETER JACOBS	Voting Delegate
<b>GEORGIA</b>	NINO JERENASHVILI	Voting Delegate
<b>GERMANY</b>	CLAUDIA BOKEL ALEXANDER BÖHM GORDON RAPP REKA SZABO	Voting Delegate
<b>GHANA</b>	MOHAMMED MAHADI	Voting Delegate
<b>GREECE</b>	IOANNIS LIGNOS	Voting Delegate
<b>GUATEMALA</b>	OTTO BALDERRAMOS	Voting Delegate
<b>GUAM</b>	ANTHONY CAMACHO	Voting Delegate
<b>GUYANA</b>	AVINASH SOMIR	Voting Delegate
<b>HAITI</b>	SAGINE DORCIL DUKERNS LOUIS JOSEPH	Voting Delegate
<b>HONDURAS</b>	Represented by Uruguay	
<b>HONG KONG</b>	WING SUN ALEXANDER N WALSON YEUNG	Voting Delegate
<b>HUNGARY</b>	ZSOLT CSAMPA	Voting Delegate
<b>INDONESIA</b>	AGUS SUPARMANTO	Voting Delegate
<b>INDIA</b>	RAJEEV MEHTA	Voting Delegate

<b>IRAN</b>	ALIREZA POURSALEMANI	Voting Delegate
<b>IRELAND</b>	URSULA KAPPUS NUALA MCGARRITY	Voting Delegate
<b>IRAQ</b>	ZEYAD SALEEM HASSAN AL MUSAWI	Voting Delegate
<b>ICELAND</b>	NIKOLAY IVANOV MATEEV	Voting Delegate
<b>ISRAEL</b>	JOSEF HARARI	Voting Delegate
<b>VIRGIN ISLANDS</b>	ANDRES FRIEBUS JOYCE BOLANOS	Voting Delegate
<b>ITALY</b>	MAURIZIO RANDAZZO GIUSEPPE CAFIERO	Voting Delegate
<b>JAMAICA</b>	JAMES MCBEAN	Voting Delegate
<b>JORDAN</b>	KHALED ATIYAT	Voting Delegate
<b>JAPAN</b>	KIYOSHI WADA ITSUKI NISHIZAWA SHUNSUKE SAKA YUSUKE AOKI	Voting Delegate
<b>KAZAKHSTAN</b>	MIRBULAT ABUOV DMITRIY GRYAZNOV ELMIR ALIMZHANOV	Voting Delegate
<b>KENYA</b>	SIMON NDICHU STEPHEN KUYA	Voting Delegate
<b>KYRGYZSTAN</b>	OSMONZHAN KASYMOV	Voting Delegate
<b>KOREA</b>	JONG HYUNG CHO	Voting Delegate
<b>SAUDI ARABIA</b>	AHMED ALSABBAN	Voting Delegate
<b>KUWAIT</b>	ABDULLAH ALWAALAN	Voting Delegate
<b>LATVIA</b>	BAIBA BRANDULE	Voting Delegate
<b>LIBYA</b>	DHW TOUMI	Voting Delegate
<b>LEBANON</b>	JIHAD SALAMEH IMAD NAHAS	Voting Delegate
<b>LITHUANIA</b>	AIDA VENGALE	Voting Delegate
<b>LUXEMBOURG</b>	PASCAL TESCH GÉRARD ZENS	Voting Delegate
<b>MACAO</b>	U CHUN CHAN IN I LAO	Voting Delegate
<b>MADAGASCAR</b>	MICKAEL RAKOTONDRAMANANA	Voting Delegate
<b>MONACO</b>	Represented by France	
<b>MOROCCO</b>	MOHAMMED NAHI	Voting Delegate
<b>MALAYSIA</b>	AINAA FARIK	Voting Delegate
<b>MOLDOVA</b>	OLGA COJOCARI MIHAIL PAGHIEV	Voting Delegate
<b>MEXICO</b>	JORGE CASTRO	Voting Delegate
<b>MONGOLIA</b>	DORJSUREN GANBAATAR	Voting Delegate
<b>NORTH MACEDONIA</b>	ZORAN STOJANOVIC	Voting Delegate
<b>MALI</b>	WAHABOU ZOROME	Voting Delegate



<b>MAURITIUS</b>	VEENA GUNPUT	Voting Delegate
<b>MAURITANIA</b>	ABDALLAHI EL MOUSTAPH	Voting Delegate
<b>MYANMAR</b>	Represented by Uzbekistan	
<b>NICARAGUA</b>	WILLIAM GENET	Voting Delegate
<b>NETHERLANDS</b>	LEON PIJNAPPEL ETIENNE VAN CANN BERT VAN DE FLIER	Voting Delegate
<b>NEPAL</b>	SUNIL KUMAR SHRESTHA	Voting Delegate
<b>NIGERIA</b>	ADEYINKA SAMUEL	Voting Delegate
<b>NIGER</b>	TIEMO ADAMOU IDRISSE	Voting Delegate
<b>NORWAY</b>	BJØRN FAYE	Voting Delegate
<b>NEW ZEALAND</b>	DAVID ELDER	Voting Delegate
<b>OMAN</b>	Represented by Kazakhstan	
<b>PAKISTAN</b>	USMAN AHMED	Voting Delegate
<b>PANAMA</b>	SOLMORAINE AMEGLIO DE DORATI	Voting Delegate
<b>PAPUA NEW GUINEA</b>	Represented by New Zealand	
<b>PARAGUAY</b>	MIGUEL ANGEL PAREDES FASSINO	Voting Delegate
<b>PERU</b>	MARIEL SIFUENTES CRUZ	Voting Delegate
<b>PHILIPPINES</b>	LEAH GONZALEZ	Voting Delegate
<b>PALESTINE</b>	DAWOUD MITWALI	Voting Delegate
<b>POLAND</b>	PIOTR GIRDWOYN	Voting Delegate
<b>PORTUGAL</b>	CLAUSO NEVES	Voting Delegate
<b>PUERTO RICO</b>	JUAN CARLOS RAMIREZ CONCEPCION	Voting Delegate
<b>QATAR</b>	KHALID AL HAMADI MASSIMO OMERI	Voting Delegate
<b>ROMANIA</b>	MARIUS FLOREA ROXANA BARLADEANU	Voting Delegate
<b>SOUTH AFRICA</b>	MICHAEL STAFFORD LOUISE LOMBARD	Voting Delegate
<b>RUSSIA</b>	ILGAR MAMEDOV EKATERINA KONDRATEVA	Voting Delegate
<b>RWANDA</b>	PAUL OGAA PACIFIQUE MUTESA	Voting Delegate
<b>SAMOA</b>	HELEN SMITH	Voting Delegate
<b>SAN MARINO</b>	Represented by Italy	
<b>SENEGAL</b>	OUMAR MAIGA MAMADOU SY	Voting Delegate
<b>SINGAPORE</b>	JULIANA SEOW	Voting Delegate
<b>SERBIA</b>	DEJAN RUSKI VUKASIN STOSIC	Voting Delegate
<b>SLOVENIA</b>	Represented by Croatia	
<b>SRI LANKA</b>	SAMANTHI WEERASINGHE AJITH SIYAMBALAPITIYA	Voting Delegate
<b>SWITZERLAND</b>	LARS FRAUCHIGER	Voting Delegate

<b>SLOVAK REPUBLIC</b>	ATTILA ERSEK	Voting Delegate
<b>SWEDEN</b>	OTTO DRAKENBERG ANA VALERO-COLLANTES	Voting Delegate
<b>SYRIA</b>	AHMAD ALREFAAI	Voting Delegate
<b>THAILAND</b>	CHANCHAI YOSSUNDARA	Voting Delegate
<b>TAJIKISTAN</b>	TURAI ABDURAKHMON	Voting Delegate
<b>TURKMENISTAN</b>	MERET MEREDOV	Voting Delegate
<b>TOGO</b>	AMI BRIGITTE DJEWA	Voting Delegate
<b>CHINESE TAIPEI</b>	KOVACS LIN	Voting Delegate
<b>TUNISIA</b>	MOHAMED SOFIANE CHAOUACHI	Voting Delegate
<b>TÜRKIYE</b>	MURAT ATALI ABDUSSAMET ARSLAN	Voting Delegate
<b>UNITED ARAB EMIRATES</b>	MOUSA ALBLOOSHI	Voting Delegate
<b>UGANDA</b>	KENNETH ORINGO	Voting Delegate
<b>UKRAINE</b>	SERGII MISHCHENKO NATALIIA CONRAD OLGA KHARLAN	Voting Delegate
<b>URUGUAY</b>	DIAMANTE PEIRANO LUIS FILARDI	Voting Delegate
<b>UNITED STATES OF AMERICA</b>	RITA COMES GREG MASSIALAS JENNIFER YAMIN KELLY KOEHLER LORRIE MARCIL-HOLMES	Voting Delegate
<b>UZBEKISTAN</b>	GULNORA SAIDOVA	Voting Delegate
<b>VENEZUELA</b>	FRANCISCO RAFAEL MARÍN ALVAREZ	Voting Delegate
<b>VIETNAM</b>	LE QUANG PHUNG	Voting Delegate
<b>YEMEN</b>	Represented by Iraq	Voting Delegate
	SEYMOUR BAGNELL	LUMI Global
	ALEXANDER HAMPSHIRE	LUMI Global
	EDWARD GARDINER	Notary, from Cheeswrights Notaries Public
	JORGE IBARROLA	Attorney at Law, Libra Law

## Agenda

- 1.** Validation of attendances and proxies
- 2.** Address of the Interim President
- 3.** Decisions regarding athletes and officials from Russia and Belarus
- 4.** Update of the Olympic qualification system

# 1. Validation of attendance and proxies

*[Everybody is connecting and testing the sound and channel.]*

**Nathalie Rodriguez:** Good morning, good afternoon, good evening, good night to everyone. Some of you are late, we are trying to enter them as soon as possible. Before we move forward, I would like to introduce the notary, who is in the office of Lumi and I would like to give the floor to Mr. Gardiner, who is the Notary next to Lumi. Mister Gardiner?

**Edward Gardiner:** Thank you Nathalie and good morning, everyone. Or good... Hello to everyone. Just to confirm I am Edward Gardiner, and I am a notary of an established notarial firm in the city of London. And I will be the appointed today to oversee the online voting process and all the matters. And most importantly I will be making sure that during any voting, absolutely nothing happens to the voting platform. And most importantly that any vote submitted are totally anonymous. And I will be producing a report after the meeting. Ok, thank you.

**Nathalie Rodriguez:** Thank you Mister Gardiner. I will also introduce the FIE lawyer, who is in the FIE meeting room. So, Mr. Ibarrola.

**Jorge Ibarrola:** Good morning, good afternoon, good evening. My name is Jorge Ibarrola, I am an attorney at law, Swiss qualified attorney at law registered with the bar of the Canton de Vaud, Switzerland. And I am here for any reasons that ... to be helpful for the holding of this general assembly. Thank you very much.

**Nathalie Rodriguez:** So, we are going to start now with the roll call and after this with the list of proxies. Guatemala has raised the hand. Yes, Guatemala? Guatemala?

**Guatemala:** Present.

**Nathalie Rodriguez:** No. You have raised your hand. We start with the roll call. When I will call your federation, please unmute yourself, and say present. So, I will start. Algeria?

**Algeria:** Present.

**Nathalie Rodriguez:** Algeria.

**Algeria:** Good Morning, Present.

**Nathalie Rodriguez:** Present. Thank you. Angola? Angola? Angola are you present? Can Lumi tell us if Angola is connected?

**Lumi:** Angola is not currently connected.

**Nathalie Rodriguez:** Not yet connected. Ok, I will come back to them. Antigua and Barbuda? Antigua and Barbuda are you present?

**Antigua and Barbuda:** Good morning. Yes, I am present.

**Nathalie Rodriguez:** Thank you. Argentina?

**Argentina:** Present.

**Nathalie Rodriguez:** Thank you. Armenia? Armenia? Is Armenia present? Lumi, is Armenia connected?

**Lumi:** Armenia is connected to the Lumi platform.

**Nathalie Rodriguez:** So, Armenia, can you say present? So, I will come back to Armenia after. Aruba? Is Aruba present? Is Aruba connected? Lumi, is Aruba connected?

**Lumi:** Aruba has logged in to the Lumi platform.

**Nathalie Rodriguez:** Aruba, are you here? So, I will come back to you after. American Samoa?

**American Samoa:** Present.

**Nathalie Rodriguez:** Thank you. Australia?

**Australia:** Present.

**Nathalie Rodriguez:** Thank you. Azerbaijan?

**Azerbaijan:** Present.

**Nathalie Rodriguez:** Thank you. Belgium?

**Belgium:** Present.

**Nathalie Rodriguez:** Thank you. Benin? Benin?

**Benin:** Present.

**Nathalie Rodriguez:** Thank you. Belarus?

**Belarus:** Present.

**Nathalie Rodriguez:** Thank you. Bolivia? Bolivia? Is Bolivia connected?

**Lumi:** Bolivia is not connected to the Lumi platform.

**Nathalie Rodriguez:** It is, or it is not?

**Lumi:** Is not.

**Nathalie Rodriguez:** I will come back to them. Botswana? Botswana? Is Botswana connected, please?

**Lumi:** Yes, Botswana is connected to the Lumi platform.

**Nathalie Rodriguez:** Ok. Botswana are you present? Botswana? Is Botswana present or not?

**Botswana:** Botswana is present.

**Nathalie Rodriguez:** Thank you. Brazil?

**Brazil:** Brazil is here. Brazil is present.

**Nathalie Rodriguez:** Thank you. Bahrain?

**Bahrain:** Present.

**Nathalie Rodriguez:** Thank you. Brunei?

**Brunei:** Present.

**Nathalie Rodriguez:** Thank you. Bulgaria? Bulgaria? Is Bulgaria present? Is Bulgaria connected?

**Lumi:** Yes, Bulgaria is connected to the Lumi platform.

**Nathalie Rodriguez:** Thank you. Bulgaria, are you present? I will come back to you after. Burkina Faso? Burkina Faso, can you please confirm if you are present? Burkina Faso? I will come back to Burkina Faso<sup>1</sup>. Cambodia?

**Cambodia:** Yes, present.

**Nathalie Rodriguez:** Thank you. Canada?

**Canada:** Canada, present, Nathalie.

**Nathalie Rodriguez:** Merci, Yann. Congo? Congo? Is Congo connected?

**Lumi:** Congo is not connected to the Lumi platform.

**Nathalie Rodriguez:** Thank you. Chile?

**Chile:** Present.

**Nathalie Rodriguez:** Thank you. China? China? China? Is China connected?

**Lumi:** Yes, China is connected to the Lumi platform.

**Nathalie Rodriguez:** Thank you. China? Can you please answer? Are you present? Ok. I will come back to China. Côte d'Ivoire?

**China:** Present, sorry. China is present.

---

1. Burkina Faso confirmed its presence in the chat.

**Nathalie Rodriguez:** China is present. Ok. Côte d'Ivoire? Côte d'Ivoire? Is Côte d'Ivoire connected?

**Lumi:** Yes, Côte d'Ivoire is connected to the Lumi platform.

**Nathalie Rodriguez:** Thank you. Côte d'Ivoire, are you present? Ok, we will come back to them. Cameroon? Cameroon? Are you present? Cameroon? We will come back to Cameroon. Democratic Republic of Congo?

**Democratic Republic of Congo:** Present. We are present.

**Nathalie Rodriguez:** Thank you. Colombia? Colombia? Are you present, Colombia? We will come back to Colombia. Cape Verde?

**Cape Verde:** Present.

**Nathalie Rodriguez:** Is Cape Verde present?

**Cape Verde:** Present.

**Nathalie Rodriguez:** Ok. Present, very good. Costa Rica?

**Costa Rica:** Costa Rica, present.

**Nathalie Rodriguez:** Thank you. Croatia?

**Croatia:** Present.

**Nathalie Rodriguez:** Thank you. Cuba? – Are you present, Cuba?

**Cuba:** Cuba is present, present.

**Nathalie Rodriguez:** Yes, very good. – Good. Czech Republic?

**Czech Republic:** Czech Republic is present.

**Nathalie Rodriguez:** Thank you. Denmark? Is Denmark present? Denmark can you say if you are present?

**Denmark:** Yes, Denmark is present.

**Nathalie Rodriguez:** Ok. Dominica? We will come back to Dominica. Dominican Republic? – The Dominican Republic is present, correct? Yes, in the chat. Ecuador? Ecuador?

**Ecuador:** Present.

**Nathalie Rodriguez:** Thank you. Egypt?

**Egypt:** Present.

**Nathalie Rodriguez:** Thank you. El Salvador?

**El Salvador:** El Salvador. – Present.

**Nathalie Rodriguez:** - Thank you. Spain?

**Spain:** Present.

**Nathalie Rodriguez:** Thank you. Estonia?

**Estonia:** Estonia, present.

**Nathalie Rodriguez:** Thank you. Finland?

**Finland:** Present.

**Nathalie Rodriguez:** Thank you. France?

**France:** Present.

**Nathalie Rodriguez:** Thank You. Great Britain?

**Great Britain:** Present.

**Nathalie Rodriguez:** Thank you. Georgia?

**Georgia:** Present.

**Nathalie Rodriguez:** Thank you. Germany?

**Germany:** Present.

**Nathalie Rodriguez:** Thank you. Ghana?

**Ghana:** Ghana, present.

**Nathalie Rodriguez:** Thank you. Greece?

**Greece:** Present.

**Nathalie Rodriguez:** Thank you. Guatemala? Guatemala?

**Guatemala:** Present.

**Nathalie Rodriguez:** Thank you. Guinea?



**Guinea<sup>2</sup>:** Present.

**Nathalie Rodriguez:** Thank you. Guam?

**Guam:** Present.

**Nathalie Rodriguez:** Thank you. Guyana?

**Guyana:** Present.

**Nathalie Rodriguez:** Thank you. Haiti?

**Haiti:** Present.

**Nathalie Rodriguez:** Thank you. Hong Kong?

**Hong Kong:** Hi, present.

**Nathalie Rodriguez:** Thank you. Hungary? Hungary?

**Hungary:** Present.

**Nathalie Rodriguez:** Thank you. Indonesia?

**Indonesia:** Present.

**Nathalie Rodriguez:** Thank you. India?

**India:** Yes present.

**Nathalie Rodriguez:** Thank you. Iran?

**Iran:** Present.

**Nathalie Rodriguez:** Thank you. Ireland?

**Ireland:** Present.

**Nathalie Rodriguez:** Thank you. I called Iran before.

**Iran:** Yes, Nathalie. I am present.

**Nathalie Rodriguez:** Thank you. Iraq?

**Iraq:** Present.

---

2. Guinea not connected on Lumi platform, not taken into account as voting delegate.

**Nathalie Rodriguez:** Thank you. Iceland?

**Iceland:** Yes, present in Budapest.

**Nathalie Rodriguez:** Thank you. Israel?

**Israel:** Present.

**Nathalie Rodriguez:** Thank you. Virgin Islands? Virgin Islands? Ok we will come back to you after. Italy?

**Italy:** Present.

**Nathalie Rodriguez:** Thank you. Jamaica?

**Jamaica:** Present.

**Nathalie Rodriguez:** Thank you. Jordan?

**Jordan:** Present.

**Nathalie Rodriguez:** Thank you. Japan?

**Japan:** Present.

**Nathalie Rodriguez:** Thank you. Kazakhstan?

**Kazakhstan:** Present.

**Nathalie Rodriguez:** Thank you. Kenya?

**Kenya:** Present.

**Nathalie Rodriguez:** Thank you. Kyrgyzstan?

**Kyrgyzstan:** Yes.

**Nathalie Rodriguez:** Thank you. Korea?

**Korea:** Present.

**Nathalie Rodriguez:** Thank you. Saudi Arabia? Saudi Arabia?

**Saudi Arabia:** Yes, present.

**Nathalie Rodriguez:** Thank you. Kuwait?

**Kuwait:** Present.

**Nathalie Rodriguez:** Present, Kuwait?

**Kuwait:** Present, present. Yes.

**Nathalie Rodriguez:** Thank you. Latvia?

**Latvia:** Latvia is present.

**Nathalie Rodriguez:** Thank you. Libya?

**Libya:** Yes, present.

**Nathalie Rodriguez:** Lebanon?

**Lebanon:** Present.

**Nathalie Rodriguez:** Thank you. Lithuania? Lithuania? Lithuania? Ok, we will come back to you. Luxembourg?

**Luxembourg:** Luxembourg is present.

**Nathalie Rodriguez:** Thank you. Macao?

**Macao:** Macao is present.

**Nathalie Rodriguez:** Thank you. Madagascar? Is Madagascar present?

**Madagascar:** We are present.

**Nathalie Rodriguez:** Thank you. Morocco?

**Morocco:** Present.

**Nathalie Rodriguez:** Thank you. Malaysia?

**Malaysia:** Malaysia is present.

**Nathalie Rodriguez:** Thank you. Moldova?

**Moldova:** Present.

**Nathalie Rodriguez:** Thank you. Mexico? Mexico?

**Mexico:** Mexico present.

**Nathalie Rodriguez:** Thank you. Mongolia?

**Mongolia:** Mongolia, present, present.

**Nathalie Rodriguez:** Thank you. North Macedonia?

**North Macedonia:** Present.

**Nathalie Rodriguez:** Thank you. Mali?

**Mali:** Mali is present.

**Nathalie Rodriguez:** Thank you. Mauritius? Mauritius? Mauritius ? Ok, we will come back to you. Mauritania?

**Mauritania:** Mauritania is present.

**Nathalie Rodriguez:** Thank you. Namibia? Namibia is present? So, we'll come back to you. Nicaragua?

**Nicaragua:** Nicaragua present.

**Nathalie Rodriguez:** Thank you. Netherlands? Netherlands? Netherlands, are you present? So, we will come back to you. Nepal?

**Nepal:** Present.

**Nathalie Rodriguez:** Thank you. Nigeria?

**Nigeria:** Present.

**Nathalie Rodriguez:** Thank you. Niger? Niger? Niger<sup>3</sup>? So, we will come back to you. Norway?

**Norway:** Norway, present.

**Nathalie Rodriguez:** Thank you. New Zealand?

**New Zealand:** Present.

**Nathalie Rodriguez:** Thank you. Pakistan? Pakistan? Pakistan? We will come back to you. Panama?

**Panama:** Present.

**Nathalie Rodriguez:** Thank you. Paraguay? Paraguay? Paraguay? We will come back to you<sup>4</sup>. Peru? Peru?

**Peru:** Present. Present.

**Nathalie Rodriguez:** Thank you. Philippines?

**Philippines:** Present.

---

3. Niger confirmed its presence in the chat.

4. Paraguay has confirmed its presence in the chat.

**Nathalie Rodriguez:** Thank you. Palestine?

**Palestine:** Present.

**Nathalie Rodriguez:** Thank you. Poland?

**Poland:** Hello, Poland is present.

**Nathalie Rodriguez:** Thank you. Portugal?

**Portugal:** Present.

**Nathalie Rodriguez:** Thank you. Puerto Rico?

**Puerto Rico:** Present.

**Nathalie Rodriguez:** Thank you. Qatar?

**Qatar:** Present.

**Nathalie Rodriguez:** Thank you. Romania?

**Romania:** Present.

**Nathalie Rodriguez:** Thank you. South Africa?

**South Africa:** South Africa, present.

**Nathalie Rodriguez:** Thank you. Russia?

**Russia:** Russia, present.

**Nathalie Rodriguez:** Thank you. Rwanda? Rwanda? We will come back to you.

**Rwanda:** Present.

**Nathalie Rodriguez:** Rwanda?

**Rwanda:** Rwanda is here.

**Nathalie Rodriguez:** Very good. Samoa?

**Samoa:** Present.

**Nathalie Rodriguez:** Thank you. Senegal?

**Senegal:** Present.

**Nathalie Rodriguez:** Thank you. Singapore?

**Singapore:** Present.

**Nathalie Rodriguez:** Thank you. Serbia?

**Serbia:** Serbia is present.

**Nathalie Rodriguez:** Thank you. Sri Lanka? Sri Lanka?

**Sri Lanka:** Present. Sri Lanka present.

**Nathalie Rodriguez:** Thank you. Switzerland? Switzerland? Are you present, Switzerland? Well, I will come back to you<sup>5</sup>. Slovakia?

**Slovakia:** Slovakia is present.

**Nathalie Rodriguez:** Thank you. Sweden?

**Sweden:** Present.

**Nathalie Rodriguez:** Thank you. Syrian Arab Republic? Syria? Syria? Ok, we will come back to you. Thailand?

**Thailand:** Thailand is present.

**Nathalie Rodriguez:** Tajikistan? Thank you. Tajikistan?

**Tajikistan:** Yes, present.

**Nathalie Rodriguez:** Thank you. Turkmenistan?

**Turkmenistan:** Yes, present.

**Nathalie Rodriguez:** Thank you. Togo? Togo? Togo? I will come back to Togo. Chinese Taipei?

**Chinese Taipei:** Taipei, present.

**Nathalie Rodriguez:** Thank you. Tunisia? Tunisia?

**Tunisia:** Present, Tunisia is present.

**Nathalie Rodriguez:** Thank you. Türkiye? Are you present? Türkiye?

**Lumi:** Türkiye had logged on to the Lumi platform.

**Nathalie Rodriguez:** Thank you. Türkiye? Ok we will come back to you. United Arab Emirates?

---

5. Switzerland has confirmed its presence in the chat.

**United Arab Emirates:** Present.

**Nathalie Rodriguez:** Thank you. Uganda?

**Uganda:** Present.

**Nathalie Rodriguez:** Thank you. Ukraine?

**Ukraine:** Present.

**Nathalie Rodriguez:** Thank you. Uruguay?

**Uruguay:** Uruguay present.

**Nathalie Rodriguez:** Thank you. USA?

**USA:** Present.

**Nathalie Rodriguez:** Thank you. Uzbekistan? Uzbekistan?

**Lumi:** Uzbekistan are logged in to the platform.

**Nathalie Rodriguez:** Thank you. Uzbekistan? Are you present? So, we will come back to you. Venezuela?

**Venezuela:** Venezuela is present.

**Nathalie Rodriguez:** Thank you. Vietnam?

**Vietnam:** Present.

**Nathalie Rodriguez:** Ok. I will come back to the countries which did not answer. So, Côte d'Ivoire, are you there? Côte d'Ivoire? Is Côte d'Ivoire connected?

**Lumi:** Côte d'Ivoire is connected to the platform.

**Nathalie Rodriguez:** Thank you. So, Côte d'Ivoire, thank you for letting me know your presence. Côte d'Ivoire? Cameroon? Cameroon?

**Lumi:** Cameroon are logged in to the platform.

**Nathalie Rodriguez:** Mister Marcel Amougou, Cameroon, are you present? We will come back to you. Colombia? Colombia?

**Lumi:** Colombia is not logged in to the platform.

**Nathalie Rodriguez:** Ok. Colombia is not present. Cape Verde? Cape Verde?

**Lumi:** Cape Verde are logged in.

**Cape Verde:** Present.

**Nathalie Rodriguez:** Ah, present. Ok. Dominica, are you present?

**Côte d'Ivoire:** Côte d'Ivoire is present.

**Nathalie Rodriguez:** Ah! Côte d'Ivoire is present. Very good. Dominica is present. Ok. I see it in the chat. Mauritius? Are you present? Mauritius are you present? Is Mauritius connected?

**Bulgaria:** Bulgaria is present.

**Nathalie Rodriguez:** Lumi, is Mauritius connected?

**Lumi:** Yes. Mauritius is connected to the platform.

**China:** China is present.

**Nathalie Rodriguez:** China is present. Ok. Thank you.

**Uzbekistan:** Uzbekistan is present.

**Nathalie Rodriguez:** Uzbekistan is present.

**Bolivia:** Bolivia is present.

**Nathalie Rodriguez:** Yes, thank you. Bolivia is present and Bulgaria is present.

**Armenia:** Armenia also present.

**Nathalie Rodriguez:** Armenia is present. Ok. Aruba?

**Lithuania:** Lithuania is present.

**Nathalie Rodriguez:** Ok. Lithuania is present. Ok.

**Lumi:** Aruba is connected to the platform.

**Pakistan:** Pakistan also present.

**Nathalie Rodriguez:** Dominica is present. And Nigeria is present.

**Netherlands:** The Netherlands is also present. Thank you.

**Pakistan:** Pakistan is also present.



**Nathalie Rodriguez:** Ok. Netherlands is present. Thank you. Pakistan is present fine. Aruba is present, I see in the chat.

**Türkiye:** Türkiye is present.

**Nathalie Rodriguez:** Türkiye is present. Thank you. I see that the Switzerland is also present. Very good. Togo is present too. I see in the chat. Colombia? Colombia?

**Colombia:** Present.

**Nathalie Rodriguez:** Thank you. Colombia is present. Cameroon? Cameroon?

**Cameroon:** Cameroon is present. Cameroon is present.

**Nathalie Rodriguez:** Thank you. Very good. What is... Is there any country that...

**Virgin Islands:** Virgin Islands is present.

**Nathalie Rodriguez:** Virgin Islands is present, thank you.

**Bolivia:** Bolivia is present.

**Nathalie Rodriguez:** Bolivia, I know. So, Mauritius? Are you present?

**Michael Stafford (RSA):** Mauritius is present in the chat.

**Nathalie Rodriguez:** Ok, thank you. And I see that... Rwanda is present.

**Côte d'Ivoire:** Côte d'Ivoire is present; Côte d'Ivoire is present.

**Nathalie Rodriguez:** Yes, thank you. Syria? Is Syria present? Syria are you present? Lumi is Syria connected?

**Lumi:** Yes, Syria is connected.

**Nathalie Rodriguez:** So, Mauritius is present as I can see in the chat. Are there any countries, that is federations that I did not call? Angola are you here? Angola? Is Angola connected?

**Lumi:** Angola are connected to the platform.

**Nathalie Rodriguez:** Angola can you say that you are present? Angola?

**Zeyad Saleem (IRQ):** Madam Nathalie, Syria is present but not with audio.

**Nathalie Rodriguez:** Sorry?

**Syria:** Syria.

**Nathalie Rodriguez:** Oh, Syria you are here. Thank you.

**Syria:** Welcome.

**Lumi:** Nathalie just to say, Turkmenistan appears to be connected to the Zoom, but Turkmenistan is not connected to the Lumi platform.

**Nathalie Rodriguez:** Turkmenistan is not connected to the Lumi platform?

**Lumi:** That is correct.

**Nathalie Rodriguez:** So, Turkmenistan, you have to connect to the Lumi platform. You are connected only on Zoom now. So, Angola is present, thank you. So, is there any country that I did not call?

**Lumi:** Just to confirm that Turkmenistan is now connected to the platform.

**Nathalie Rodriguez:** Thank you. So, if...

**Bolivia:** Miss Rodriguez, Bolivia is connected to the Lumi platform?

**Nathalie Rodriguez:** Yes, yes. No problem. You are registered. Thank you. So, if all countries are called, I will now move to the proxies.

**Helen Smith (MH, AUS):** Nathalie, is Congo here? Congo?

**Nathalie Rodriguez:** Congo? Where?

**Helen Smith (MH, AUS):** Is it present? Because I thought they did not answer when you first call.

**Nathalie Rodriguez:** Lumi, is Congo connected?

**Lumi:** Which Congo you are referring to?

**Nathalie Rodriguez:** Congo. C-G-O. The other one is the Republic Democratic of Congo, I am calling Congo.

**Lumi:** CGO is not connected to the platform.

**Nathalie Rodriguez:** Is not connected. So, it means they are absent.

**Democratic Republic of Congo:** Present.

**Nathalie Rodriguez:** Who is present?

**Mbagnick Ndiayé:** The two Congo are there. Congo is there with its general secretary.

**Nathalie Rodriguez:** Both?

**Michel Maunza (COD):** Congo Democratic present.

**Nathalie Rodriguez:** Lumi, are CGO and COD connected?

**Lumi:** COD is connected; CGO is not connected.

**Nathalie Rodriguez:** So, Congo is not connected to the Lumi platform. Congo, CGO has to connect on the Lumi platform, not only on Zoom.

**Mbagnick Ndiayé:** What does that mean? Madam Nathalie?

**Nathalie Rodriguez:** Yes?

**Mbagnick Ndiayé:** I want to understand. Which of the Congo? Democratic or Congo Brazza?

**Nathalie Rodriguez:** No, C-G-O, C-G-O. Not COD, C-G-O.

**Mbagnick Ndiayé:** Ok, but what are they connected to?

**Nathalie Rodriguez:** They are connected on Zoom, but not on Lumi.

**Mbagnick Ndiayé:** So, are they valid or are they not valid?

**Nathalie Rodriguez:** No, they have to connect to Lumi.

**Mbagnick Ndiayé:** Ah, ok. It is a problem of understanding.

**Nathalie Rodriguez:** COD is connected. CGO is not connected.

**Mbagnick Ndiayé:** Ok, I will call them. It is connection problems.

**Nathalie Rodriguez:** So, we move now to the proxies. Afghanistan has given proxy to Kyrgyzstan. Does Kyrgyzstan accept?

**Kyrgyzstan:** Yes, yes, yes.

**Nathalie Rodriguez:** You accept. Ok. Austria has given proxy to Germany. Does Germany accept?

**Germany:** Yes.

**Nathalie Rodriguez:** Thank you. Bahamas has given proxy to Guyana. Does Guyana accept?

**Guyana:** Yes.

**Nathalie Rodriguez:** Thank you. Barbados has given proxy to Venezuela. Does Venezuela accept?

**Venezuela:** Yes, I accept.

**Nathalie Rodriguez:** Thank you. Belize has given proxy to Costa Rica. Does Costa Rica accept?

**Costa Rica:** Yes, we accept.

**Nathalie Rodriguez:** Thank you. Cyprus has given proxy to Greece. Does Greece accept?

**Greece:** Yes, I accept.

**Nathalie Rodriguez:** Thank you. Honduras has given proxy to Uruguay. Does Uruguay accept? Uruguay?

**Uruguay:** I accept.

**Nathalie Rodriguez:** Thank you. Monaco has given proxy to France. Does France accept? Does France accept the proxy of Monaco?

**France:** France accepts the proxy.

**Nathalie Rodriguez:** Thank you. Myanmar has given proxy to Uzbekistan. Does Uzbekistan accept?

**Uzbekistan:** Yes, we accept.

**Nathalie Rodriguez:** Thank you. Oman has given proxy to Kazakhstan. Does Kazakhstan accept?

**Kazakhstan:** Yes, I accept.

**Nathalie Rodriguez:** Thank you. Papua New Guinea has given proxy to New Zealand. Does New Zealand accept?

**New Zealand:** Yes, I accept.

**Nathalie Rodriguez:** Thank you. San Marino has given proxy to Italy. Does Italy accept?

**Italy:** Yes, accept.

**Nathalie Rodriguez:** Thank you. Slovenia has given proxy to Croatia. Does Croatia accept?

**Croatia:** Yes, we accept Slovenian proxy.

**Nathalie Rodriguez:** Thank you. Yemen has given proxy to Iraq. Does Iraq accept? Iraq?

**Iraq:** Accept, yes.

**Nathalie Rodriguez:** Ok, thank you. So now, Lumi. I would like to know if Congo has connected. CGO?

**Lumi:** No, CGO is not connected to the voting platform.

**Nathalie Rodriguez:** CGO you are connected to Zoom but not to Lumi. CGO, please, connect on Lumi.

**Lumi:** CGO has still not connected to the Lumi platform. We are not sure if they are connected to Zoom. If someone wants to check that.

**Nathalie Rodriguez:** CGO is not connected to either Lumi or Zoom. If you are not logged in within 30 seconds, we will be forced to consider you as absent.

*30 seconds waiting time*

**Nathalie Rodriguez:** Good. The floor will be now to Lumi and to the notary to check and to display the number of federations present and the number of federations represented. If Congo or another federation arrives later after this, Lumi will inform us.

**Lumi:** Thank you.

**Nathalie Rodriguez:** So, we have 132 federations present and 14 represented, for a total of 146 for the moment. Thank you.

**Lumi:** That is correct. I confirm. Thank you.

**Nathalie Rodriguez:** So, the floor is now to the Interim President, Emmanuel Katsiadakis.

## 2. Address of the FIE Interim President

**Emmanuel Katsiadakis (MH):** Dear Members of Honour, Dear Members of the Executive Committee, Dear Members of Commissions and Councils, Dear Presidents, and Representatives of the National Federations, I welcome you in Extraordinary Congress of FIE.

As you know, the Executive Committee unanimously decided during its meeting of 25th November 2022, to organise an extraordinary Congress at the beginning of March, as the Olympic Qualification period starts in April 2023, and a decision must be made on the participation or not of athletes and officials from the Russian Fencing Federation and the Belarusian Fencing Federation.

Since the 2022 Congress, several events occupied in the Olympic Movement, including an Olympic Summit on December 9th, 2022.

Following this Summit, the IOC held consultation calls with the IOC Members, the Global Network of athletes' representatives, the International Federations, and the National Olympic Committees (NOCs) on 17th and 19th January 2023.

The IOC published a press release on January 25th, 2023, indicating that:

I quote:

"With regard to the athletes with Russian and Belarusian passports, the vast majority of the participants in each of the consultation calls expressed the following:

- a) Strong commitment to the unifying mission of the Olympic Movement, requesting and encouraging it to live up to this unifying mission, particularly in these times of division, confrontation, and war.
- b) Respect the rights of all athletes to be treated without any discrimination, in accordance with the Olympic Charter.
- c) Governments must not decide which athletes can participate in which competition and which athletes cannot.
- d) No athlete should be prevented from competing just because of their passport.
- e) A pathway for athletes' participation in competition under strict conditions should therefore be further explored."

End of quote

As of today, the recommendations of the IOC of February 28th, 2022, are still in place.

However, the IOC Executive Committee shall meet from March 28th to 30th, and we expect to receive recommendations or decisions regarding international competitions.

IOC decisions regarding the Paris 2024 Olympic Games are not expected at this stage. Therefore, item 4 of the agenda cannot be dealt with today, as IOC decisions on the Paris 2024 Olympic Games from the IOC have not been made.

In January and February, the Executive Committee met several times to discuss in depth the situation of athletes and officials from the Russian and Belarusian Federations in the FIE. A vote took place, and the Executive Committee was in favour of their participation in FIE competitions. As a reminder, and as stated during the 2022 Congress, the Executive Committee does not want to exclude the Russian and Belarusian athletes from the Olympic qualification. It is, however, up to the Congress to decide.

The Executive Committee has therefore prepared the questions that are submitted to you and which you have received one week ago.

I am sure that everyone in this congress will show respect to the FIE values and its code of conduct. We are all members of the same FIE family. Thank you.

**Nathalie Rodriguez:** Thank you.

**Emmanuel Katsiadakis (MH):** Now, the last few days, we received two letters. One from Mr. Joonas Lyytinen, if I say correct the name, of the Nordic Fencing Union. And one from the Ukrainian Fencing Federation.

The letter from Mr. Lyytinen has 9 questions to be put before the Congress. We believe that they are of general interest. Therefore, we will read these questions together with our answers. And I ask from Nathalie Rodriguez: to help me to say... to start to say the questions and after I will say the answers. Thank you.

**Nathalie Rodriguez:** So, question number 1: What does the "personal eligibility" mentioned in the questions put forward to the Extraordinary Congress mean in practice, what is the process of determining this eligibility and who will make the decision on compliance to these?

**Emmanuel Katsiadakis (MH):** Ok. FIE administrative rules article 1.2 means that athletes who participate in FIE competitions undertake to first abide by the provisions of FIE rules and statutes, second respect the FIE adopting rules, use neither prohibited substances nor prohibited methods and agreed to undergo any in-competitions and out of competitions tests. In addition, the athletes will have to respect the Congress decisions, respect the Executive Committee decisions. Decisions as to non-compliance with these conditions will be made according to the FIE statutes and rules. IOC full recommendations, decisions are to be received at the end of March.

**Nathalie Rodriguez:** Question number 2: What will the consequences be if Russian and Belarusian athletes are allowed to participate and fail to be "in compliance with the conditions of neutrality"? What will be the process to investigate and validate suspected instances of non-compliance and who will make the decision on possible consequences?

**Emmanuel Katsiadakis (MH):** Ok, IOC statement of January 25th, 2023, the point 3.F says in the event of any athlete failing to respect the eligibility criteria or failing to respect the strict participation conditions, the IFs, special for us the FIE, and all the sports event organisers concerned should immediately remove them from the competitions. The FIE should suspend them from the further competitions and report the incident to the IOC for its consideration for further measures and sanctions. Violation of conditions of neutrality will be investigated by the FIE, taking into consideration the recommendations and decisions of IOC.

**Nathalie Rodriguez:** Question number 3: Several countries do not issue visas to Russian or Belarusian citizens and do not allow them to enter the country. What steps are FIE going to take to tackle this problem if international competitions are organised in these countries?

**Emmanuel Katsiadakis (MH):** FIE will take all necessary steps to avoid organising international competitions in any country that does not respect the principle of equality for all athletes, including issuing visas to all participating athletes. As per article 2.6.5 of the Administrative Rules, the Executive Committee will try to relocate the competition as it did when other similar cases happened in the past. And with the refusal of visas all due to the COVID-19 measures which were not in line with the FIE rules.

**Nathalie Rodriguez:** Question number 4: Many governments have stated that they will withdraw monetary support from national sports organisations participating in competition with Russian and Belarusian athletes. Will FIE reimburse these financial losses to these national fencing federations?

**Emmanuel Katsiadakis (MH):** Terms and conditions for monetary support by governments being domestic matters of each country, the FIE does not intervene in such matters. The FIE is an autonomous non-governmental organisation which is recognized by the IOC as the organisation which governs the sport of fencing worldwide in accordance with the rules of the Olympic charter. Article 2.1.1a Statutes states the national federation must have an independent role in accordance with the principles of Olympic charter. The FIE cannot be held responsible for decisions of governments. The FIE is committed to follow the decisions of the FIE Congress and to be compliant with the IOC recommendations and decisions.

**Nathalie Rodriguez:** Question number 5: Several national federations are at risk of losing sponsorships from private enterprises if they participate in competitions with Russian or Belarusian athletes. Will FIE reimburse this lost revenue to the national fencing federations?

**Emmanuel Katsiadakis (MH):** The FIE does not intervene in matters concerning terms and conditions regarding sponsorships of federations by private entities. The FIE cannot be held responsible for decisions of private enterprises.

**Nathalie Rodriguez:** Question number 6: What are the concrete plans and actions that FIE will implement for security and safeguarding if the Russian and Belarusian athletes are allowed to participate in international competitions?

**Emmanuel Katsiadakis (MH):** The FIE is well aware that the safety and security of the competitions is a matter of the utmost importance in these times. In collaboration with the organisers of each competitions, the FIE undertakes to organise safe and secure competitions for everyone involved. Organising federations will have to hire a private security company at the expenses of the FIE to ensure security. Members of the Executive Committee and senior staff will also be present to support the supervisor or event manager or safeguarding officers for possible safeguarding issues.

**Nathalie Rodriguez:** Question number 7: What kind of consequences or penalties will athletes from other countries face from FIE if they decline to fence against Russian or Belarusian athletes in international competitions due to personal ethical and moral reasons?

**Emmanuel Katsiadakis (MH):** If the athletes are absent or if they are not present on the piste, on the strip at the start of the match, the article of the rules such as o.74 or o.79 etc. apply. For other circumstances this would not be in the first instance of athletes refusing to fence against athletes of other country for personal reasons there are specific provisions in the FIE statutes and rules.



**Nathalie Rodriguez:** Question number 8: The IOC is trying to uncover the possibilities for Russian and Belarusian athletes to participate in tournaments again. In what way will it be beneficial for fencing to be among the first Federations to take a position?

**Emmanuel Katsiadakis (MH):** The IOC is aware of the situation of each International Federation in terms of Olympic qualifications system and period. The IOC also approved the FIE Olympic qualification system. Fencing is starting its Olympic qualification in April 2023 and has no other choice than to make a decision before that period. Recommendations, decisions of the IOC are expected at the end of March. The Executive Committee does not seek to establish any benefit by proposing a vote on the questions put before the Congress. Simply put, it wishes to have in place a reliable ranking in the qualification system, if, and only if, the IOC decides that Russian and Belarusian athletes are allowed to compete in the 2024 Olympic Games. Should the IOC decide to exclude the Russian and Belarusian athletes at the Olympics, the position in the ranking will be off. No consequence.

**Nathalie Rodriguez:** Question number 9: Since we still have not elected a new president due to our president's self-suspension, will the bond between the FIE and Russian interests be perceived as too tight, and could damage FIE's public image and lead to loss of goodwill in the IOC and general public?

**Emmanuel Katsiadakis (MH):** I am sorry... so, this is a question for me.

**Nathalie Rodriguez:** No, question number 9. Question number 9. Yes, number 9.

**Emmanuel Katsiadakis (MH):** Question number 9? It is a question very close of mine. So, the FIE is an independent body with no ties to the self-suspended President. The appointment of the Interim President has been confirmed by the Congress of November 2022 and the IOC has confirmed about it. The Interim President maintains bonds of friendship and respect with the 155 members federations and the FIE does not have special interest with any of them. I am a really independent President. Thank you.

**Nathalie Rodriguez:** So, these are the answers that can be provided to the questions that were sent by the Nordic Fencing Union. Do you have any questions on this or any comments?

### 3. Decisions regarding athletes and officials from Russia and Belarus

**Nathalie Rodriguez:** So now we will move to the second letter that the FIE has received. Mr. Katsiadakis will inform about the letter of Ukraine.

**Emmanuel Katsiadakis (MH):** Yes, yes. We received this letter from the Ukrainian Fencing Federation and the request of the Federation is the following. The first question is to exclude from the agenda for the FIE online Extraordinary Congress scheduled for 10th March 2023 the point for discussion, voting or any other actions, including directives or instructions by FIE authorities, regarding the admission of Russian and/or Belarusian fencers from the qualifying competitions to participate in the Olympic Games 2024 and any other international competitions. This is the first request.

And the second request is to refrain from deciding the matters specified in paragraph 1, until the complaint of the Ukrainian Fencing Federation is duly considered with making a final decision in accordance with the FIE ethical code and the FIE disciplinary code, including the consideration of the complaint in all instances of the Court of Arbitration for Sport and if necessary, in Swiss courts. These are the two requests from the Ukrainian Fencing Federation.

**Nathalie Rodriguez:** So, I see that Vadym Guttsait and Pascal Tesch want the floor. So, Vadym Guttsait, the floor is yours.

**Vadym Guttsait (UKR):** Hello my friends, hello my colleagues, hello my fencers brothers, my family fencers. Some words about the situation. A year has passed since the Russian troops with the support of Belarus invaded the territory of independent Ukraine, violating the Olympic Truce. The basic Olympic principles and values of peaceful coexistence, friendship and mutual respect were violated. The decision and recommendation taken by the IOC to prevent Russian and Belarusian athletes from participating in international competitions were logical and absolutely fair. Introduction of sanction against violators of the Olympic charter, the international sport order, the fair restriction of the rights of athletes and entourage, they can be lifted only after correction of the violation, the end of Russia's war with the support of Belarus against Ukraine. I must emphasize that the war is supported by the head of NOC of Russia and Belarus, by the vast majority of the sport federations of these countries including fencing one, judges, coaches. In my opinion, we do not have the... Russian and Belarusian to sport arenas, while Ukraine and sport community suffers new losses. During this war, 251 Ukrainian athletes and coaches were killed. About 40'000 athletes were forced to move abroad, about 350 sport facilities were severely destroyed or damaged. The war affects every Ukrainian fencer. Someone lost their family or friends. Colleagues, someone lost their home; someone lost their training opportunities. We do not have understand what equal conditions with Russian and Belarusian athletes can be discussed in principle. The IOC recommendation on ban for Belarusian and Russian athletes is still valid. This why there is not background for us to discuss any change. I believe until war stops, we cannot let Russian and Belarusian fencers to come back to the competitions within the FIE authority in any status. I ask you to support the idea of prolongation of the ban. I thank you and I ask you for that solidarity with Ukrainians during this difficult time. Thank you so much.

**Emmanuel Katsiadakis (MH):** Thank you.

**Nathalie Rodriguez:** Pascal Tesch, Luxemburg.

**Pascal Tesch (LUX):** Thank you, Madam Chairman. Thank you also, Mister President ad Interim, for these

extensive and creative answers put forward. I want to come back to question number one about neutrality. When I researched about neutrality, I inspired myself with International Red Cross. The word “neutral” comes from the Latin “neuter” and it means neither one thing nor the other. So, it could be considered someone neutral whoever refrains from participating in a conflict or altercation and abstains from any interference. The reasons for that can be numerous. So, the definition can also take various aspects. However, I missed to hear any of the reasons, any of the aspects in the explanation we heard a few minutes ago.

**Emmanuel Katsiadakis (MH):** Thank you Pascal. So, I give again the floor to...

**Nathalie Rodriguez:** Excuse me, excuse me. Venezuela wants the floor.

**Emmanuel Katsiadakis (MH):** Ah! Sorry.

**Nathalie Rodriguez:** Venezuela.

**Francisco Rafael Marín Alvarez (VEN):** Hello, good afternoon, greetings to all the fencing family. I just want to come back to the intervention I made at the last congress. Let’s not turn this congress, let’s not turn this working table into a political debate. I would like to emphasize, again, my country; I am not going to talk about other countries. Venezuela has been subjected to a blockade for more than five years in which people have died. Those presidents in the neighbourhood here who like to look at the figures and statistics of international organisations, look at the number of deaths in Venezuela. In the last five years, the number of displaced people as a result of the crisis has become a point of discussion for decisions that are purely political. Because it does not apply for me, as president, to ask for the sanction of the athletes of those countries that for political reasons have a blockade on Venezuela, which also generates deaths, which also generates displaced people, which also generates problems such as...

**Nathalie Rodriguez:** I think Venezuela has a connection problem.

**Emmanuel Katsiadakis (MH):** Yes. There is another person.

**Avinash Somir (GUY):** Hello everyone, I would like to thank the FIE for supporting athletes within a difficult time. You know, future of fencing relies on family, friendship, and youth development. Athletes are not politicians and should not be treated as such. Us, as adults, we should be the mentors that set the right example of humanity and respect so that the youth can learn. So... Just wanted to thank the FIE again for doing the best that they can to support athletes in this difficult time and I appreciate all that the FIE is doing already. Thank you.

**Emmanuel Katsiadakis (MH):** Any others?

**Nathalie Rodriguez:** Ghana?

**Mohammed Mahadi (GHA):** Hello. Ok, Madame Nathalie, greeting to everyone. I sympathize with every country that has suffered the great casualties in all wars. Can you hear me?

**Emmanuel Katsiadakis (MH):** We hear you, yes.

**Mohammed Mahadi (GHA):** Ok, I sympathize with every country that has had great losses in many, many wars in the history, going back to what happened in Afghanistan, in Iraq, in Libya and then what is going on in

Ukraine and then Palestine which is ongoing. But then the greatest achievement of sports is autonomy of sports. Which was the resolution passed by the United Nations in its 69's Congress. Now, that resolution separates us and gives us the autonomy to take decisions separately from what politicians do. If we should go on and say that we are going to sanction every athlete who has no direct involvement or has no say in national policy, because the country is in war, we suspend athletes then we are taking the path of destroying our lovely sport. I believe the mutuality and autonomy of sports should be respected and we should separate the athletes and athletes are driven by our rules and regulations of the various disciplines. I believe that if we maintain this mutuality of us being sportsmen and the politicians deal with their matters and then we play the mutual rule of communicating our solidarity in enhancing and promoting peace in our activity by opening our arms and calling everyone to demonstrate in the peace, that we can live or have coexistence with everyone by allowing our athletes from Russia and Belarus to come and compete and demonstrating solidarity and peaceful coexistence. Because by allowing them to come and compete is demonstrating to the world that we truly stand for peace as athletes. But if we keep them aside and allow the Ukrainian to compete, where is our neutrality? Fairness should be applied by allowing every athlete to compete on the FIE tournaments so we can demonstrate that indeed fencing really stands for peace and fencing really promotes coexistence and then mutuality. Thank you.

**Nathalie Rodriguez:** Thank you. So, we will come back to Venezuela, then we have Ukraine, Sweden, and Finland. So, Venezuela, Ukraine, Sweden, and Finland. Venezuela please.

**Francisco Rafael Marín Alvarez (VEN):** Yes, thank you. Sorry, I had connection problems. I was saying that, given the point of neutrality, political neutrality is laid down in the UNESCO charter, in the Olympic charter and this political neutrality speaks of what the colleague from Ghana referred to. None of our athletes, none of us presidents have the capacity to influence the directives and the political guidelines of our rulers. Therefore, please, let us not turn a sporting debate into a political debate. I repeat: all my solidarity with those countries that are in a war. All my solidarity with all the lives lost because we are also experiencing it in a different way, but we are also experiencing it. However, at this moment, we are called by sport, by Olympism and by the great fencing family that we are, to set an example of peace, unity, and integration on a fencing piste. Just as in previous years, other sports have done in other conflicts. This is our opportunity to be united and at peace and not to give political responsibility to those who do not have it. Because the athletes of the world, not of any country, are not politically responsible for the actions of their rulers. So, let's talk about the Olympic Charter, let's talk about the statutes of the FIE. That is all that can be discussed here, let's talk about sport, please let's not turn this space into a political debate. Thank you.

**Nathalie Rodriguez:** Thank you. Ukraine.

**Emmanuel Katsiadakis (MH):** We do not hear you.

**Nathalie Rodriguez:** You are muted.

**Olga Kharlan (UKR):** Yes. Hello everyone. You can hear me, right?

**Nathalie Rodriguez:** Yes.

**Olga Kharlan (UKR):** Dear fencing family, I am the same Olga Kharlan, I will always be Ukrainian from Ukraine. Four months ago, I was standing in front of you and questioning which Olympic values weight more; friendship, excellence, respect. Due to agenda of today's Congress, it is evident that some of you are still questioning themselves. Do the apply of the Olympic values value more than human live? Yesterday from 12 a.m. to the

morning 7 a.m., Russians and Belarusians had blown and strike with all existent type of missiles including ballistic. 12 cities and regions of Ukraine: Kiev, Mykolaiv, Odessa, Lviv and more were under shelling, simultaneously targeted with 81, 81 missiles and 8 drones. They were infrastructures ruined, but civil victims again who did not wake up and were burned under their houses. What is the fair play in sport today? Could the fair play be more... more when, how Vadym said, the more than 300 sport facilities in Ukraine are destroyed? 231 athletes are killed in war already and you need to find the courage to train despite the life testing you hardly without electricity and heating, internet connection failures, daily air alarms. To respect to those who keep silent still, how in order of friendship to shake hands with the Russian and Belarusian fencers as fencing etiquette requires... Sorry? ... requires after bout on the strips. Knowing that just one more attack, one more fight in Bakhmut or where else in Ukraine costs another life or Ukrainian soldiers and new shelling took away one more civil life. You do know that many athletes and officials from Russia, Belarus are calling themselves sergeants, soldiers, and officers of the State institution as military forces, polices, borders services. Those who give and swear allegiance, swear allegiance to them and are paid as well as preparation is financed by their terrorist state. Is already more than one year of the war its full-scale invasion, one year of the war itself is of Ukraine. More than one year of terrorist attacks, missiles attacks, authority of crimes, murders of Ukrainians by Russians military forces. Today, speaking here, I am asking each of fencing family what future do we stand for? Yes, sure, we stand for peace, and we should point the way that Russian, Belarus participation is not possible until the war is not finished. No use of athletes in State propaganda. You might not know, but the leader of sabre women team was visiting military base in Syria as Russian armed forces captain right after the Olympics of 2016. Is in public domain. Europe faces this terrible war; the world faces this terrible war. It is not finished. We keep... We have to keep fencing crystal clear, not compromise in this war crimes executed by state, Putin's shared responsibility on individuals. Together we will win, we can win. We have to be strong and united to protect sport from terrorism and its policy on sport stages. Glory to sport, glory to peace, glory to Ukraine. Thank you for your attention.

**Nathalie Rodriguez:** Thank you. Sweden?

**Otto Drakenberg (SWE):** Can you hear me, Nathalie?

**Nathalie Rodriguez:** Yes, I can.

**Otto Drakenberg (SWE):** Very good. Thank you and hello everyone in the FIE Congress. We, in the Swedish Fencing Federation firmly believe that given there has been no change in the situation regarding the Russian aggression in Ukraine and it is an imperative for fairness and solidarity toward the Ukrainian athletes, whose facilities has been destroyed and who have to leave the country or to stay to fight for the defence of Ukraine in which very many have lost their lives. There is no practical reason to move away from the exclusion regime for Russian and Belarusian athletes set by the FIE in its 2022 statement. The Swedish Fencing Federation also note that through their choices, actions, and ongoing invasion, Russia broke the Olympic Truce that has been continuously supported by the United Nations General Assembly since 1993. In Russia and Belarus, sport and politics are closely intertwined. We have strong concerns on how feasible it is for Russian and Belarusian Olympic athletes to compete as neutrals under the IOC conditions of no identification with their country when they are directly funded and supported by their States. The strong links and affiliations between Russian athletes and Russian military are also of clear concern. Our approach throughout has therefore never been one of discrimination simply on the bases of nationality but this strong concerns need to be dealt with by the FIE. As long as these fundamental issues are not addressed, we do not agree that Russian and Belarusian athletes should be allowed back into competition. We, the Swedish Fencing Federation, strongly therefore urge the FIE to address the questions, identify, and reconsider its proposal accordingly. We also note that Russia and Belarus have it in their own hands to pave the way for their athletes' full return to the international sports community namely by

ending the war that they themselves started. In summary, Swedish fencing is strictly against allowing Russian and Belarusian athletes to participate in FIE competitions, whether individually or in team, from the second half of April 2023. And we are strictly against allowing Russian or Belarusian officials to attend FIE competitions from the second half of April 2023. Nor should any official from Russia or Belarus be allowed to hold positions within any organisational body of the FIE. Thank you.

**Nathalie Rodriguez:** Thank you. Finland?

**Joonas Lyytinen (FIN):** Thank you Nathalie, dear friends. The heart of all sports is a fair competition. And under the current circumstances, there cannot be fair competitions for the Ukrainians fencers. As we heard hundreds of Ukrainian athletes have been killed by the war that was illegally started by the Russian Federation and supported by the Belarusian government. There is no possibility of having fair competition when your athletes are killed by aggressive military actions from another state. The Ukrainian facilities have been destroyed; they cannot practice. Millions of Ukrainians has been forced to leave their country. And nobody can believe that Ukrainians can compete in a fair competition under these circumstances. And the least thing we can do, is to not to allow the people representing the aggressor in sport, to compete either. The Russians athletes as I thought I said in the Congress already are also victims of the Russian Federation and of the actions of the Russian government. But that is the decisions of the Russian government and that is not something that is in our power. And if you think that we can stay neutral when another country invades and kills people and athletes and countries and destroys facilities of another country, in our fencing family, I would like to remind you, my dear friends, that the sports community and the International community was not neutral when the South African apartheid government denied humans rights and questioned the humanity of black South Africans. We took the sports community as a collective ...big... a very strong stand and excluded the South African apartheid government from international sports. And we can go through, be different injustices of yesterday and the past and think when should have acted and why we did not act in the past. But we cannot change the past, only thing we can change is the future and the current situation. And for all my friends from the global south that think they have been mistreated or neglected I would strongly suggest that you would raise your voice and ask people and ask the international sports community to take action against injustice. We will support you. The European fencing federations and the EFC has been very clear, it is a war namely affects the Europe and Europeans as we all know. And the stands of the great majority of member federations of the European Fencing Federation have been very clear. We do not see that the Russians and the Belarusians can come back to international sport at this point. And people from other zonal confederations, I would ask you to respect the will of the Europeans in this intra-European conflict. Thank you very much.

**Nathalie Rodriguez:** Thank you. Russia?

**Ilgar Mamedov (RUS):** Hello everybody, dear Congress, dear colleagues, I would like to say one remark concerning our military organisation, as all, everybody has in their own country, we have military games and we have CISM, therefore we have, for example, in our country, CSKA centre sport club army. And Olga Kharlan spoke about our attitude, and it is absolutely incorrect information. In Ukraine, in Belarus, in Romania, in France, in Germany, in Korea, in China everybody has military organisations. This because without military organisations we cannot participate in military games and military world championships. If someone does not know about it, this is just information for you. And I agree with the colleague from Venezuela and from Ghana that we are athletes, we are sportsmen and how is more participations if our athletes cannot support this military problem in the two countries. How it will be if, for example, we are not participating two years more. We are not working for the government; we are only athletes. Coaches and athletes, we are all, we are always in our sport venue, we work, and we can fight only on the piste, only on the piste. And I was thinking that maybe someone does not

want to compete against us because Russian Fencing Federation is the strongest federation, fencing federation in the world. Last two Olympic games showed that we had more medals than other teams and maybe someone has a good chance to not have opponent like Russian athletes. This is a big problem in my understand. And I do not want to speak about politics again. We are athletes and I hope you understand me, you understand my words, because many, many years we are organizing the games [not audible] my relationship with you colleagues. If you remembered in the last Congress in Lausanne, I proposed to Ukrainian Fencing Federation my personal help, but they refused. How can we show to everybody that we want to have peace between our two countries? We can do it through our sport. Thank you very much.

**Nathalie Rodriguez:** Thank you. Burkina Faso? We cannot hear you. Please open your microphone. Can you raise the sound volume of your microphone? Mister Zeba, we cannot hear you. The volume of your microphone is too low. Your microphone is off. We cannot hear you. Your microphone is off. We are going to hear Ghana, then we will come back to Burkina.

Ghana you wanted to talk. Is there anyone else who would like to take the floor?

Burkina we still cannot hear you.

Nobody else wants to take the floor. So, Botswana? And then Ghana.

**Mandlenkosi Masuku (BOT):** Thank you, Madam CEO, am I audible?

**Nathalie Rodriguez:** Yes, who is speaking?

**Mandlenkosi Masuku (BOT):** Oh, Masuku, Botswana.

**Nathalie Rodriguez:** Botswana, fine. Thank you.

**Mandlenkosi Masuku (BOT):** Thank you. As much as fencing is a combat sport, is not an army and should not be associated with political differences and unrests. Fencing must be seen as a sport that promotes unity and peace and bringing all humans together. It is unfortunate that there are losses of lives, and we are sympathetic about it. But sport should bring nations together. Segregation of any athletes by virtues of political unrests in war will only fuel unrest. If fencing was the reason for the war, then FIE should take drastic measures but it is not the case. Thank you very much.

**Nathalie Rodriguez:** Thank you. Ghana?

**Mohammed Mahadi (GHA):** Yes, I am back again. All I wanted to say again is that the war and wars will still continue as long as we are human beings who agree to disagree. We just hope that, in our discords, we should always value peace. Apartheid and a lot of these have been giving references. And I believe that it was an error when politics or politicians were dictating even who the head of federations should be until the passage of the UN resolution which I keep making reference to. Which separated politics from sports. I was tense in taking a political line of side-lining or punishing our athletes based on country or governmental discords. It's like throwing ourselves again and throwing the autonomy which we have won to the bin again on throwing ourselves in the hands of the politicians. Sport is a global language as our president, Thomas Bach, said. Sport is the only endeavour that brings us together regardless of our political, religious, or racial differences. Therefore, I urge and call against that. Let us give the platform to all fencers so that we can demonstrate as fencers, as FIE seeing



fencing from Belarusians and from Russians competing with their brothers, not as the enemies from Ukraine and other parts of the world. So, we do not emulate the example that we have witnessed that we cannot control, whenever Israeli athletes are competing with other Arab athletes. We should be careful in the path we are taking, and we should correct a mistake by allowing them to come and we manage the situation. Thank you.

**Nathalie Rodriguez:** Thank you. Cameroon? Your microphone is not open.

**Dieudonné Marcel Amougou Nguina (CMR):** Can you hear me?

**Nathalie Rodriguez:** Yes, we can.

**Dieudonné Marcel Amougou Nguina (CMR):** So, I wanted to say that I am making the constate... Can you hear me?

**Nathalie Rodriguez:** We hear you.

**Dieudonné Marcel Amougou Nguina (CMR):** I wanted to say that I see that we are in the same situation as at the Lausanne Congress in November, where people took the floor to express their position on the Russian or Belarusian athletes. I think that it was in view of the long debates we had in Lausanne that we decided on this Extraordinary Congress. So, we would do better, we all know why we are here today. We would do better to go to the votes instead of everyone taking the floor to say that they are for or against. The ballot box will tell us, we are in a democracy. The ballot box will be able to tell us whether the majority is for or against. I think that we have been wasting time for, well, nothing, as far as I am concerned. That is it.

**Nathalie Rodriguez:** Thank you. Niger? Your microphone.

**Tiemo Adamou Idrissa (NIG):** Yes, good morning. So, first of all, I would like to thank you for giving me the opportunity to speak. As the senior member just said, Amougou, I think it would be better to go straight to the vote than to dwell on debates that will prolong the time. And that there are other points that are perhaps more interesting. As he says, this is a democracy, so let's let the ballot box speak. Thank you very much.

**Nathalie Rodriguez:** Thank you. USA?

**Rita Comes (USA):** Thank you. I want to read a statement from USA Federation. It was in a press release by Sam Cheri, and he spoke these words during the Congress in November.

"Today is a critical day, when the member federations show whether their ethical and moral values are stronger than political experience of pleasing those who are lobbying for their votes with promises of a quid-pro-quo. I and the US Federation are firmly against permitting the competitors of any country, some of whom are in or supported by its military establishment that is committing war crimes against civilians of another country, to compete. If these athletes wish to compete let them resign any military ties and financing, renounce their citizenship, and disavow their support for the atrocities. If this sounds like drastic and extreme measures, they are. But invasion of a sovereign country and the killing of its civilians is also drastic and extreme. An extreme transgression calls for extreme responses. Many of these competitors are guilty, directly, or indirectly, of supporting actively or passively their aggressor government. Those in Russia who passively watched give tacit approval to the current reprehensible activities." Thank you.



**Nathalie Rodriguez:** Thank you. Does anyone else wants to take the floor?

**Emmanuel Katsiadakis (MH):** So, there is any other, Nathalie?

**Nathalie Rodriguez:** Virgin Islands.

**Joyce Bolanos (ISV):** Yeah. Can you hear me?

**Nathalie Rodriguez:** Yes, we can.

**Joyce Bolanos (ISV):** Yes. We must remain neutral. If we take side, half of the countries of the world will not be competing. There is blood in every country. We must remain neutral. We are a sport under the Olympic flag. We are a family, sport should unite. If we start taking sides, then half of the countries will not be competing today. There are still conflicts around the World. In the future there will be conflicts, you know, war, there will be many wars. But we must remain neutral. We are a sport; we are a family. And think about it, if today we applied by taking sides half of the countries would not be competing. So, we must remain a sport, a family and keep... You know... When we are competing, we are a family. We must be united. And yes, you know, it is horrible, terrible what is happening, but this is the moment that we must unite as a family, and no one is... no one... most of the countries have been in conflict. And I think just very, you know... I want everybody to really think the decision we are going to take today. And that is what I have to say. We have to unite as a family and keep sport sport. Thank you.

**Nathalie Rodriguez:** Thank you. Lebanon?

**Jihad Salameh (LBN):** I just want to say something about what we are talking about. If we take the Olympic Charter, the fundamental principles of Olympism, there is Article 4 which says: The practice of sport is a human right. Every individual must have the opportunity to practice sport without discrimination of any kind, of any kind. And in the Olympic spirit which requires mutual understanding, the spirit of friendship, solidarity, and fair play. So, if we base ourselves on the fundamental principles of the Olympic Charter, we cannot discriminate any athlete in any form. If we are all under the Olympic Charter.

**Nathalie Rodriguez:** Thank you. Is there anyone else who would like to take the floor? Nobody? Nobody wants to take the floor? Norway.

**Bjørn Faye (NOR):** Hello, can you hear me?

**Nathalie Rodriguez:** Yes, we can.

**Bjørn Faye (NOR):** In a way I can agree with those who said we should vote. But I also think that since this is a democratic organisation, people should be able to have their say. I also feel that we owe an apology to the President of the Swedish Fencing Federation for the way the Congress behaved when he was talking. That was a disgrace, absolutely not a good way of showing sportsmanship and allowing different opinions to be forwarded. Ok. Thank you.

**Nathalie Rodriguez:** Thank you. Anyone else wants to take the floor? No one else wants to take the floor? Nobody else wants to take the floor?

**Emmanuel Katsiadakis (MH):** Ok, so its ok now? Nobody else? Do you hear me?

**Nathalie Rodriguez:** Yes. We can hear you.

**Emmanuel Katsiadakis (MH):** ok, so if there is no other person to take the floor, I think during this discussion and opinions of our representatives, I think the Congress will now consider this letter of Ukrainian Fencing Federation and the two propositions sent to us. So, I think the CEO takes the floor and start the procedure for these two requests.

**Nathalie Rodriguez:** So, as the Interim President said, there are two requests from the Ukrainian Federation. And these requests are a change in the agenda. As you know it was decided in November that there would be an Extraordinary Congress to vote on these issues. The Federations have received the agenda for the Congress one month ago and the Ukrainian Federation is asking to exclude the vote on this topic and to postpone the vote on this topic. So, as we are in a case of item which is a modification to the agenda, we will include these questions in the vote. However, to reach a decision, a majority of three fourths is required. So, I remind you that request one from Ukraine is to not vote today and request two is to postpone the vote to a period which is not yet determined. Before moving to these two requests on which you will be requested to vote, I suggest that we make a test vote just to make sure that everything is clear for you and that you do not have more question on how to vote. So, I propose to make a test vote, this is not a real vote. We are not going to vote on the questions, we first move to a test vote. And I give the floor to the notary and to Lumi for the test vote, just for you to check that everything is fine. So, this is just a test question for you to test your voting device and check that everything is fine, and I give the floor to the notary.

**Edward Gardiner:** Thank you Nathalie. And just to remind all voting delegates that all voting will be done through the Lumi voting platform. So, the test vote is as follows: Was fencing on the programme of the 1896 Olympic Games in Athens? And the vote is now open.

**Nathalie Rodriguez:** So, you remember that only the voting delegates have access to the Lumi voting platform. All the other delegates can see the question displayed on the screen. And I was informed by Lumi that Congo had arrived. Is that correct? Mister Gardiner, can you confirm that Congo had arrived?

**Edward Gardiner:** We are just checking this, thank you. Nathalie for Congo, we have the second delegate logged on, but not the voting delegate.

**Nathalie Rodriguez:** Ok. So, Congo is absent.

**Edward Gardiner:** So, the poll will close in 1 minute.

The poll will close in 30 seconds. And just as a reminder that all voting needs to be done on the Lumi online voting platform.

The poll will close in 10 seconds.

The poll is now closed, and the results will be displayed shortly.

The results of the voting were as follows: **there was 130 Federations voted, there were 4 abstentions, there were 126 valid ballots. The majority required 64. Yes: 119. No: 7.** Thank you, and I hand

the floor back.

**Nathalie Rodriguez:** Thank you. So, we can see that 16 Federations did not vote. So, please, we ask you to vote. I think that if you are attending that Congress, it is for that reason. So now that we have... Yes, Bolivia. Bolivia?

**Viviana Chacón Urdininea (BOL):** Yes, Madame I did not have the chance to vote because the poll was open, but it did not let me vote.

**Nathalie Rodriguez:** But are you on a computer or on a telephone?

**Viviana Chacón Urdininea (BOL):** I am on a computer.

**Nathalie Rodriguez:** And do you have two screens in front of you? One for Zoom and one for Lumi?

**Viviana Chacón Urdininea (BOL):** Yes, yes, yes. It was on the Lumi, but it said "you are connected to the Lumi" but the poll was open. It said "the poll is open" but it could not be accessed.

**Nathalie Rodriguez:** No, "poll open" was written only on the Zoom platform.

**Viviana Chacón Urdininea (BOL):** Ah. Ok.

**Nathalie Rodriguez:** On the Lumi platform, you should have something else. Do you have your screen split in two? Do you have Zoom in one side and in the other Lumi?

**Viviana Chacón Urdininea (BOL):** No.

**Nathalie Rodriguez:** So, is your Zoom screen full screen or can you reduce your screen?

**Viviana Chacón Urdininea (BOL):** Yes, I will reduce it. Pass to another person's question, I will try and if I have problems, I will call you back.

**Nathalie Rodriguez:** Who else? Colombia?

**Mariana Vila Carvajal (COL):** Nathalie, it did not let me vote. I am on an iPhone.

**Nathalie Rodriguez:** On the iPhone, you have to be logged in on both pages: Zoom and separately Lumi. If you are only logged in on Zoom, you cannot vote because you are not logged in on Lumi.

**Mariana Vila Carvajal (COL):** Ok, I am looking how to connect to Lumi. Thank you.

**Nathalie Rodriguez:** Any other questions? Ok, so we are going to first vote on the questions from the Ukrainian Federation. The Ukrainian Federation wants not to vote today on the Russian and Belarusian athletes and officials. This is their request number one. As that question is a modification of the agenda, it cannot pass if it is not voted with three fourth of the votes. The second question is to postpone the vote until there is a final decision on their complaint. Again, as it is a modification of the agenda, it requires three fourth of the votes. So, I will give the floor now to the notary for the display of the first question from the Ukrainian Federation and to handle the vote.

**Edward Gardiner:** Thank you, Nathalie. I will first read out the matter they will be voting on, which is as follows: Request 1) from Fencing Federation of Ukraine: **Do you agree to the following: To exclude from the agenda for the FIE Online Extraordinary Congress scheduled for the 10th of March 2023 the point for discussion, voting or any other actions, including directives or instructions by FIE Authorities, regarding the admission of \*Russian\* and/or \*Belarusian\* fencers for the qualifying competitions to participate in the Olympic Games 2024 and any other international competitions?**

And the vote is now open.

The vote will close in 1 minute.

The vote will close in 30 seconds.

The vote will close in 10 seconds.

The vote is now closed, and the results will be displayed shortly.

**Nathalie Rodriguez:** So please...

**Edward Gardiner:** Thank you. The results of the voting are as follows: **133 Federations voted, there were 3 abstentions, there were 130 valid ballots and the majority required is 98. Yes: 46. No: 84.** Thank you and I hand the floor back.

**Nathalie Rodriguez:** So, the proposal did not pass. We move now to the second request from the Ukrainian Federation. And I give the floor to the notary.

**Edward Gardiner:** Thank you. And we now move to the next item to vote on, which is as follows:

Request 2) from the Fencing Federation of Ukraine: **Do you agree to the following: To refrain from deciding the matter specified in paragraph (1) above until the complaint of Ukraine Fencing Federation is duly considered with making a final decision in accordance with the FIE Ethical Code and the FIE Disciplinary Code, including the consideration of the complaint in all instances of the Court of Arbitration for Sport, and, if necessary, in Swiss courts.**

And the vote is now open.

The vote will close in 1 minute.

The vote will close in 30 seconds.

The vote will close in 10 seconds.

The vote is now closed, and the results will shortly be displayed.

The result of the voting is as follows: **134 Federations voted, there were 4 abstentions and 130 valid ballots. The required majority is 98. Yes: 46. No: 84.** Thank you and I hand the floor back.

**Nathalie Rodriguez:** So, request number 2) did not pass. We will now move to the 3 questions that were sent to you and on which we are going to vote today. You have received these questions and I will give the floor to the notary for question number 1).

**Edward Gardiner:** Thank you. And the next item to vote reads as follows, which is question 1): **Do you agree to allow athletes with an FIE Licence registered by the National Federation of Russia or Belarus and holding the respective passport (or citizenship) to participate in FIE individual competitions from the second half of April 2023, subject to possible future IOC recommendations/decisions, and in compliance with conditions of neutrality and individual eligibility?**

And the vote is now open.

The vote will close in 1 minute.

The vote will close in 30 seconds.

The vote will close in 10 seconds.

The vote is now closed, and the results will be displayed shortly.

The results of the voting were as follows: **136 Federations voted, there was 1 abstention, and 135 valid ballots. The required majority is 68. Yes: 89. No: 46.** Thank you and I hand the floor back.

**Nathalie Rodriguez:** So, the proposal passed. We now move to the second question, and I give the floor to the notary.

**Edward Gardiner:** Thank you. And the second question to be voted on is as follows: **Do you agree to allow athletes with an FIE Licence registered by the National Federation of Russia or Belarus and holding the respective passport (or citizenship) to participate in FIE team competitions from the second half of April 2023, subject to possible future IOC recommendations/decisions, and in compliance with conditions of neutrality and individual eligibility?**

And the vote is now open.

The vote will close in 1 minute.

The vote will close in 30 seconds.

The vote will close in 10 seconds.

The vote is now closed, and the results will be displayed shortly.

The results of the voting were as follows: **139 Federations voted, there were 3 abstentions, there were 136 valid ballots. The required majority is 69. Yes: 85. No: 51.** Thank you and I hand the floor back.

**Nathalie Rodriguez:** The proposal passed. We now move to the last question, question number 3). And I give the floor to the notary.

**Edward Gardiner:** Thank you. And the next item to be voted on is question 3) which is as follows: **Do you agree to allow officials (referees, coaches, trainers, medical staff, technical staff, members of commissions and councils) registered by the National Federation of Russia or Belarus and holding the respective passport (or citizenship) to attend FIE competitions from the second half of April 2023, subject to possible future IOC recommendations/decisions, and in compliance with conditions of neutrality and individual eligibility?**

And the vote is now open.

The vote will close in 1 minute.

The vote will close in 30 seconds.

The vote will close in 10 seconds.

The vote is now closed, and the results will be displayed shortly.

The result of the voting is as follows: there were **138 Federations voted, there were 2 abstentions, there are 136 valid ballots. The majority required is 69. Yes: 88. No: 48.** Thank you and I hand the floor back.

**Nathalie Rodriguez:** So, the proposal passed. So, I will give... We have finished with that item on the agenda. As said earlier, the next item will not be dealt now because we are...there is no decision from the IOC on the Olympic Games. So, we are not going to deal with that item and the floor now is to the Interim President.

**Emmanuel Katsiadakis (MH):** Thank you Nathalie. Thank you everybody for your participation in our Extraordinary Congress. And I hope altogether to try for the best of our Federation and to stay united in the near future. And of course, we respect in any case the decisions and the recommendations or future recommendations and decisions of IOC. Thank you very much for your participation. Thank you.

**Nathalie Rodriguez:** So, with these words from the Interim President, we have now finished with the items that had to be discussed today.

And I would like to thank all of you for your collaboration in this Extraordinary Online Congress. And I would like also to thank the translators, Lumi for the voting platform, Vector.Com for the IT management, Mr. Gardiner the notary, Mr. Ibarrola the lawyer and, last but not least, all the staff in Lausanne who has done an extraordinary and very difficult job in order to organise that meeting today. I thank them very much and I thank all those who contributed to the organisation of that event. Thank you very much.

**Sergii Mishchenko (UKR):** Hello.

**Nathalie Rodriguez:** Yes, we can hear you.

**Sergii Mishchenko (UKR):** Thank you very much and thank you very much for this important meeting. We will continue, of course, our efforts. And regarding the letter which we placed with Ethics Committee I believe it will be a fair proceeding as fair as the existing regulation. And I also would like to have for the record if you could prepare and then pass to us, maybe to allow the members, whether all the present delegates with their

federations have paid the annual fees. That is important to understand because, as I understand, only Delegations, Federations who paid the annual fees are allowed to vote. So, we would make a request, an official request to send us a list of the Federations who have paid the fees at the moment, until the moment of the Congress. Thank you.

**Nathalie Rodriguez:** So, the floor is to the Interim President and to the Treasurer regarding the decision that was made by the Executive Committee a few weeks ago, regarding the payment of the annual fee for the Extraordinary Congress.

**Sergii Mishchenko (UKR):** Thank you.

**Nathalie Rodriguez:** So, the floor is to the Interim President and then to the Treasurer. Unmute your microphone.

**Emmanuel Katsiadakis (MH):** Ok, now you can hear me?

**Nathalie Rodriguez:** Yes, we can.

**Emmanuel Katsiadakis (MH):** Ok. So, during the last Executive Committee it was... some questions from a few Federations who was not easy to pay for practical reasons. And we accept this... to accept to participate to this Congress for this Federations. And I think the Treasurer knows the names of these Federations, to say exactly the names of these Federations.

**Ferial Salhi (ALG):** Yes, in one of the last meetings, the Executive Committee decided to let all the Federations participate to the Extraordinary Congress. Because most of our Federations pay at the World Championships and it is difficult for them to make transfers and as it is an Extraordinary one, so, they have time to pay at the World Championships and before the Ordinary Congress in November.

**Nathalie Rodriguez:** The rule is that the annual fee should be paid one month before the Congress except when the Executive Committee allows the Federations to pay later on. This is one of the prerogatives of the Executive Committee and it has allowed this exception because the administrative rules say the annual fees should be paid in March and the invoices that was sent was for March, while the Extraordinary Congress was held also in March. So, the rule that applies is that the Federations have to pay their annual fees one month before the Ordinary Congress which will be in November and the Executive Committee, as it is its right, has accepted that annual fees would be paid during the Junior and Cadet World Championships or at the Senior World Championships. This was recorded in the list of decisions of the Executive Committee of the past weeks. And this is stated at that Congress and announced at that Congress.

**Sergii Mishchenko (UKR):** Hallo? Can you hear me?

**Nathalie Rodriguez:** Yes.

**Sergii Mishchenko (UKR):** Thank you very much for information. We would like to have that decision, the list of decisions of the Executive Committee. I think it is available on site. If not, then we will ask to send us such a decision. Thank you.

**Nathalie Rodriguez:** The lists of decisions of the Executive Committee are not public. They are internal to the Executive Committee. And the possibility of postponing the payment of FIE annual fees is provided for in the Statutes of the FIE. This decision was made by the Executive Committee several weeks ago and it is announced

at that Congress. So, the reasons why this has been postponed is that usually the Congress is held in November and therefore the annual fees must be paid one month before the Congress. However, this year we had an Extraordinary Congress which is an additional Congress of the FIE and the Executive Committee knows perfectly well that a number of Federations cannot make bank transfers. This is impossible for them. They pay in cash at the Junior and Cadet World Championships or at the Senior World Championships or one month before the Congress or in March when we issue the invoices. It is the prerogative of the Executive Committee to accept exception of payment and the Executive Committee made this decision, which is announced at that Extraordinary Congress.

Is there any other questions or comments?

**Sergii Mishchenko (UKR):** On my side, no questions.

**Nathalie Rodriguez:** Any other comment? Any other question? So, in that case I think the Interim President can close the Extraordinary Congress. Please unmute.

**Emmanuel Katsiadakis (MH):** Now do you hear me?

**Nathalie Rodriguez:** Yes.

**Emmanuel Katsiadakis (MH):** Ok. Thank you. I repeat, Nathalie, first of all, thank you very much for your help and all the staff. You already said thank you very much for all the participants in this Extraordinary Congress. And without to have any other items, I close this Extraordinary Congress. Thank you.

**Nathalie Rodriguez:** Thank you everyone. Have a good afternoon, evening, and night.





## DECISIONS OF THE 2023 FIE ONLINE EXTRAORDINARY CONGRESS Cf. Information letter 2-23 of 4<sup>th</sup> April 2023

---

146 federations took part in the online Extraordinary Congress of 10th March 2023, of which 132 were present and 14 were represented.

The following decisions were made:

1. To allow athletes with an FIE Licence registered by the National Federation of Russia or Belarus and holding the respective passport (or citizenship) to participate in FIE individual competitions from the second half of April 2023, subject to possible future IOC recommendations/decisions, and in compliance with conditions of neutrality and individual eligibility.
2. To allow athletes with an FIE Licence registered by the National Federation of Russia or Belarus and holding the respective passport (or citizenship) to participate in FIE team competitions from the second half of April 2023, subject to possible future IOC recommendations/decisions, and in compliance with conditions of neutrality and individual eligibility.
3. To allow officials (referees, coaches, trainers, medical staff, technical staff, members of commissions and councils) registered by the National Federation of Russia or Belarus and holding the respective passport (or citizenship) to attend FIE competitions from the second half of April 2023, subject to possible future IOC recommendations/decisions, and in compliance with conditions of neutrality and individual eligibility.



# **Annual Report of the Executive Committee 2022**

# CONTENTS

## OBITUARY

### 1. ADMINISTRATIVE ACTIVITIES

#### 1.1 Management

#### 1.2 Refereeing

- 1.2.1 Refereeing examinations
- 1.2.2 Renewal of Licenses

#### 1.3 Antidoping

- 1.3.1 Controls
- 1.3.2 Clean Sport Education

#### 1.4 Media - Digital, TV and Magazine

- 1.4.1 FIE media in 2022
- 1.4.2 Digital channels
- 1.4.3 Television
- 1.4.4 Official 2022 FIE Press Releases
- 1.4.5 Digital Magazine – ESCRIME XXI
- 1.4.6 Changes & Evolution

#### 1.5 International activities of the FIE

#### 1.6 World Fencing Day 2022

#### 1.7 FIE Safeguarding trainings

- 1.7.1 Webinar for Members of the FIE Executive Committee, Commissions, Councils and Committees
- 1.7.2 Webinars for National Federations

#### 1.8. Athletes Commission Election

#### 1.9 FIE Working Groups

#### 1.10 FIE Awards

- 1.10.1 Prize for the best referee
- 1.10.2 Hall of Fame 2022
- 1.10.3 Fair Play Trophy 2022

### 2. ASSISTANCE OF THE FIE IN SPORT DEVELOPMENT

#### 2.1. 2022 Exceptional help

#### 2.2. Training camps for athletes

#### 2.3 Oceania Fencing Master Academy (OFMA)

#### 2.4 Training academies for coaches

- 2.4.1 Johannesburg
- 2.4.2 Budapest

#### 2.5 Olympic Solidarity

#### 2.6 Equipment aid

#### 2.7 Donate your fencing gear

#### 2.8 Assistance with athletes' participation programme 2022

#### 2.9 Assistance for Confederations

#### 2.10 Assistance for competition organisers

#### 2.11 Fencing Equipment Repair Course in South Africa

## **CONTENTS**

### **2.12 Confederations activities**

- 2.12.1 European Fencing Confederation
- 2.12.2 Asian Fencing Confederation (FCA)
- 2.12.3. Pan American Fencing Confederation
- 2.12.4 Oceania Fencing Confederation
- 2.12.5 African Fencing Confederation

### **3. SPORTING ACTIVITIES**

#### **3.1 WINNERS OF OFFICIAL RANKINGS**

#### **3.2 WORLD CHAMPIONSHIPS - JUNIORS/CADETS 2022**

#### **3.3 SENIOR WORLD CHAMPIONSHIPS 2022**

#### **3.4 WORLD CHAMPIONSHIPS - VETERANS 2022**

#### **3.5 CONTINENTAL CHAMPIONSHIPS**

- 3.5.1 EUROPE
- 3.5.2 ASIA – OCEANIA
- 3.5.3. AMERICA
- 3.5.4. AFRICA

#### **3.6 MEDITERRANEAN GAMES 2022**

Ladies and Gentlemen,

This report takes account of events that took place between January 1st and December 31st, 2022.

## **OBITUARY**

The International Fencing Federation has been affected by the loss of several friends and it is with deep sadness that the FIE has learned of the passing of:

### **Olga Orban-Szabo 1938 - 2022**

Olga Orban-Szabo (ROU), multiple-time Olympic medallist and world champion and a member of the FIE Hall of Fame, passed away on January 5, 2022.

Born on October 9, 1938, in Cluj, Ms. Szabo was the first Olympic medallist and world champion for Romania, and competed in five Olympic Games (Melbourne 1956, Rome 1960, Tokyo 1964, Mexico City 1968 and Munich 1972). She earned her first Olympic medal, a silver in women's individual foil, in Melbourne, and then a bronze in women's team foil in both the Mexico City and Munich Games.

She became individual women's foil world champion at the 1962 Buenos Aires World Championships. As part of the Romanian women's foil team (including Maria Vicol, Ileana Gyulai, Ecaterina Stahl, and Ana Pascu), she took a gold medal at the 1969 Havana World Championships, another first for her country.

In all, Ms. Orban-Szabo earned 11 Olympic and World Championships medals in women's foil, including three from the Olympic Games and eight at the World Championships between 1961 and 1970. Prior to that, she was a junior world silver medallist in 1959.

She also won three medals at the Universiade, including individual silver and team gold in 1961 and team silver in 1965.

As member of the army club "Steaua Bucharest", she won the Romanian national championship seven times, and was awarded the national title of "Emeritus Master of Sport" as well as numerous Romanian orders and titles. She graduated from the Babes-Bolyai University in Cluj-Napoca and was also a fencing master. Following her retirement from competition in 1972, she worked as a youth fencing coach at her club in Bucharest.

"She was a distinguished Lady of the Romanian fencing team", stated Marius Florea, Romanian Federation President. "The Romanian Fencing Federation would like to express its deep gratitude for Mrs. Olga Orban-Szabo's contribution to the foundation of the Romanian fencing family."

### **José VALARINHO 1935 - 2022**

José Valarinho (POR), member of the FIE Hall of Fame, passed away on March 30, 2022, at the age of 87. He was a member of the FIE Disciplinary Commission from 1996 to 2004.

He was awarded a special FIE gold medal three times for his academic work on fencing as well as organising the 1988 FIE Congress in Madeira and the 2002 Lisbon World Championships. He also received the Olympic Order of the Portuguese Olympic Committee and the Medal for Sports Merits by the Portuguese government.

Mr. Valarinho was president of the Portuguese Fencing Federation for two terms beginning in 1992. He joined the organisation in 1969 as president of the Technical Commission, and over several decades he had a significant impact on the growth and

development of fencing in Portugal. He participated in a “Plan for the Development of Sports” with a special programme, “500 Foils”, and worked to support Portugal becoming more active in international fencing.

Mr. Valarinho took part in organising the first European Championships in Lisbon, 1983, as well as multiple other continental and world competitions held in Portugal during the 1980s and 1990s. His vision for Portuguese becoming a strong participant in world fencing was realised fully when his country’s men’s foil team won the gold medal at the 2000 European Championships in Madeira. After his departure from the presidency, he successfully organised the 2002 Lisbon Fencing World Championships.

Having a traditional Portuguese military education, Mr. Valarinho ultimately became an Army officer, and it was during his schooling where he first experienced fencing along with becoming a skilled equestrian. He graduated with honours as a maître at the Military Sports Centre in Mafra, where he was a competitive fencer and took part in the 1959 Universiade as a member of the men’s sabre team. Following school, he became a fencing master, specialised in recruiting and developing young fencers.

He was the author of two books on the history of Portuguese fencing and was in the process of preparing a third edition.

“He was a fencer to his dying day”, said his son, Frederico Valarinho, who has been a member of the Portuguese Fencing Federation since 2006.

### **Ana PASCU (MH) 1944 - 2022**

Ms. Ana Pascu (ROU), FIE Member of Honour and Hall of Fame member, passed away in Bucharest on April 6, 2022. She was born on September 22, 1944.

Elected in 2000, Ms. Pascu served as a member of the FIE Executive Committee, including being vice president from 2004 to 2021. Prior to that, she was a member of the FIE Rules Commission from 1984 to 1988 and of the FIE Refereeing Commission from 1988 to 1996. She was also an FIE international referee in foil and epee.

She holds the record as the longest-serving president of a Romanian Fencing Federation. From 1982 to 2013, Ms. Pascu headed the Federation, contributing to the sporting achievements of Romanian fencers who won 134 medals during her tenure, including nine at the Olympic Games, 57 at the World Championships and 68 at the European Championships. Following her retirement as president, she was appointed honorary president of the Romanian Fencing Federation. She was also vice president of the Romanian Olympic and Sports Committee.

As an athlete, Ms. Pascu was a five-time Olympic foilist, and in team foil she won a bronze medal at the 1968 and 1972 Olympic Games and the gold medal at the 1969 Havana World Championships. In individual foil, she won the Junior World Championships in 1963 as well as the bronze medal at the 1971 World Championships. As part of the Romanian Women’s Foil Team, she won the team foil silver medal at the 1970 World Championships and bronze medals at the 1961, 1967, 1971, 1973, 1974 and 1975 World Championships. In 1961 and 1965, her team won gold and silver, respectively, at the World University Games (“Universiade”).

Ms. Pascu also had a career as a fencing coach and physical education teacher until 1982, having earned a doctorate in physical education and sport. Her doctoral thesis was titled *The Strategy for Enhancing Sports Preparation in Competitions*. She also held a “Doctor Honoris Causa” from Vasile Goldis University in Romania. She authored numerous scientific and sports publications and was awarded several titles and decorations, including the National Order of Merit in the rank of Officer and Knight.

Ms. Pascu dedicated her entire life to fencing, fencers, Romanian Fencing and the FIE, and the many successes resulting from this are testament to her incredible talent and passion for our sport. In the words of Emmanuel Katsiadakis, FIE Interim President, “She tirelessly, generously and with infinite kindness helped, supported, and motivated all those who sought her help and advice. She was an outstanding mentor and role model for athletes, officials, and leaders in fencing, as well as for girls and women in sport. The fencing family has lost a great lady and an emblematic personality with rare and invaluable

human and professional qualities. She will remain in our memories, in our hearts and in our history.”

### **Mark RANCE 1963 - 2022**

Mark Rance (NZL), on May 3, 2022, passed away in Christchurch, New Zealand. He was the current president of the FIE Veterans Council until his passing and had been a member since 2016. Mr. Rance was elected to the Oceania Fencing Confederation board in 2020 and then elected vice president by the board, serving from 2020 until now. He was president of Fencing New Zealand from 2017 until October 2021.

In 2016, Mr. Rance was the chair of the organising committee for the Christchurch Commonwealth Veterans Fencing Championships, named as a finalist in the Canterbury Sports Awards. He also took a silver medal as part of the men’s epee team at the same event.

“Mark combined his love of fencing and sound business skills when working with the Veterans Council to get the best outcomes for veteran fencing worldwide”, said Rita Comes (USA), on behalf of the FIE Veterans Council. “His presence will be missed.”

Originally from England, and born on February 7, 1963, Mr. Rance was a competitive swimmer before discovering fencing at the age of 10. He fenced at the Reading Club and then at the London Thames Fencing Club for several years, achieving strong results in both regional and national events, and later participated in European tournaments and finished in the top 12 epeeists in the 1983 Junior World Championship. In the 1980s, he was considered for being a member of the British Olympic team, although several issues and an injury prevented him from attaining that goal.

Mr. Rance moved to New Zealand in the 1990s, where he lived in the South Island town of Ashburton. After a hiatus from fencing, in 2008 his passion for the sport reignited after attending an epee tournament in Christchurch; he shortly thereafter made the podium at the New Zealand Men’s National Championships. From there, he went on to represent New Zealand in both senior and veteran events globally, and in 2010 won a bronze medal in veteran individual men’s epee and silver in veteran men’s team epee at the Commonwealth Fencing Championships in Melbourne, Australia.

“Mark was always a man who was willing to help, particularly with the young people of our sport who he coached and mentored for several years”, stated David Elder, Fencing New Zealand president. “Many young fencers will sorely miss his advice and expertise.”

According to Mr. Elder, for a significant period Mr. Rance was the highest-ranked men’s veteran epeeist in Australasia (Australia and New Zealand).

### **Daniel R. DECHAINE Jr 1934 - 2022**

Daniel R. DeChaine, Jr. (USA), was a member of the FIE SEMI Commission for more than 30 years.

Born on October 29, 1934 in California, USA, he was best-known for his extensive work as a fencing armorer. He was elected to the SEMI Commission in 1985, serving until 2016. In that role, he was the chief armorer/technician and SEMI Commission representative at numerous world fencing events, including the Pan American Games; Junior, Cadet and Senior Fencing World Championships; and numerous other events. At the 1984 Los Angeles Olympic Games, he was the technical manager of fencing and the manager of armorers.

In addition to armoury, Mr. DeChaine invented, designed, and constructed test devices for fencing, including ones used at the 1976 and 1984 Olympic Games.

“For decades, Team USA athletes put their trust in Dan DeChaine”, said David Arias, chair of the USA Fencing Board of Directors. “With Dan in their corner, our athletes knew they were in good hands. Through his work with the SEMI Commission of the FIE, Dan helped design rules for fencing equipment and invent the test devices that ensured all fencers had an even



playing field. With the passing of Dan DeChaine, the international fencing community has lost a legend of the sport. His legacy will be felt at local, regional, national, and international fencing tournaments for generations.”

In 2007, Mr. DeChaine was inducted into the USA Fencing Hall of Fame, in part for his extensive contributions as the national team armorer at the Olympic Games, World Championships, World University Games and Pan American Games dating back to 1967. He was also the official fencing armorer for the Modern Pentathlon World Championships as well as a consultant to many national fencing federations on armoury, equipment and equipment selection. He served terms as the chairman and co-chairman of the National Technical Commission of the United States Fencing Association and authored numerous articles on equipment repair, maintenance and troubleshooting.

Mr. DeChaine earned a Bachelor of Arts degree in Zoology from Pomona College in 1956.

### **Ahmad Akbari JAVID 1947 – 2022**

The FIE is saddened to learn of the passing of Mr. Ahmad Akbari Javid (IRI), on Oct. 17, 2022. He was a member of the FIE Veterans’ Council from 2012 – 2016.

Mr. Javid was born on Feb. 10, 1947 and spent seven decades of his life in fencing. He competed for Iran in individual and team foil and team sabre events at the 1976 Montreal Summer Olympic Games. At the 1974 Asian Games, held in Tehran, Iran, he was a gold and bronze medallist in foil and sabre. In addition to many other achievements in international and Asian competitions, he also received bronze medals in individual men’s foil and the team sabre event at the 2017 Asian Veterans’ Championships.

He served as secretary-general of the Iranian Fencing Federation from 1993 to 1998 and 2009 to 2011, and was a member of the Veterans’ Commission of the Asian Fencing Confederation. He worked for many years as an international foil referee.

Mr. Javid founded the fencing department in the Iranian Ministry of Sports and was responsible for it from 1991 to 2009, and was the director of the Tehran Province Fencing Department from 1989 to 1999. During his life, he also held numerous other roles in Iranian fencing, including being the head of the Iranian University Sports Department. He worked as a sports professor at the Amir Kabir Polytechnic University from 1993 to 2009, chaired the Iranian Training Committee from 2010 to 2017 and was the Iranian national foil coach.

In a statement from the Iranian Fencing Federation, Mr. Javid “...was a coach who contributed all his life to fencing and sport” and “tirelessly, generously and with infinite kindness helped, supported and motivated all those who sought help and advice in fencing and sport”.

### **Alexey KUZNETSOV 1967 - 2022**

Mr. Alexey Kuznetsov (CAN) passed away on Nov. 1 of 2022, born on September 2, 1967, in Luhansk, Ukraine. He was an FIE international referee.

As an FIE foil and epee referee since 1999, Mr. Kuznetsov served at many World Cups, Grand Prix events, Zonal Championships and Games, World Championships and the University Games as well as the Rio 2016 Olympic Games.

He was president of the Pan American Fencing Confederation Federation Refereeing Commission since 2016.

For Canada, Mr. Kuznetsov was a member of the Canadian Fencing Federation Refereeing Committee and the Canadian national coach for the senior men’s foil team from 2013 to 2016. Since 1996, he coached athletes in both Canada and the USA, achieving national and international results. He also was a technical adviser for national and international competitions in Canada, for numerous years providing coaching and refereeing mentorship for the CFF.

Mr. Kuznetsov held a bachelor's degree as a fencing coach and in physical education from the Pedagogical University in Ukraine (1988).

### **Semen RIKHTMAN 1946 - 2022**

Semen Rikhtman (RUS) passed away on Dec. 6, who retired last year from the FIE SEMI Commission. He was born on August 6, 1946.

Mr. Rikhtman was president of the SEMI Commission from 2012 to 2021 and had been a member since 1992. A frequent SEMI delegate to FIE events, he worked at multiple Fencing World Championships as well as the London 2012, Rio 2016 and Tokyo 2020 Olympic Games.

From 2000 to 2012, Mr. Rikhtman was a member of the European Fencing Confederation SEMI Commission.

Mr. Rikhtman graduated with a university degree in radio electronics and was an expert in radio technology. He began developing referee and information systems in 1976 and took part in designing equipment used at major sports events, including at the Olympic Games. Over the course of his career, Mr. Rikhtman was awarded numerous patents and copyrights under his name.

### **Igor TŠIKINJOV 1961 - 2022**

Igor Tšikinšov (EST) passed away on December 8, at the age of 61. Born on June 26, 1961, in Kohtla-Järve, Estonia, he was a renowned Olympic and national coach and former fencer.

Mr. Tšikinšov participated in four Olympic Games as an epee coach, including Sydney 2000, Athens 2004 and Beijing 2008 for the Swedish national team, and Rio 2016 for the Estonian national team.

He was the senior coach of the Estonian women's epee team from 1991 to 1992, after which he was the head coach of the Swedish fencing team from 2003 to 2012. He coached the Estonian epee team from 2013 to 2018, and then from 2020 to 2021. In-between those periods with Estonia, he coached the Uzbekistan fencing team from 2018 to 2019.

His athletes won numerous international medals in epee, including Oksana Jermakova, individual world and two-time Olympic team champion; Erika Kirpu, world, and Olympic team champion; Nikolai Novosjolov, two-time world champion; and Peter Vanky, who competed in four Olympic Games and won numerous international medals. In 2015, his Estonian women's epee team won the European Championships, and the Swedish and Uzbekistan teams also achieved medals in major competitions under his coaching.

Mr. Tšikinšov began fencing in 1973. As an athlete, he became Estonian team champion in 1981 in epee and 1984-1985 in foil.

We express our sincerest condolences to the bereaved families and federations of the deceased.

# 1 ADMINISTRATIVE ACTIVITIES

## 1.1 Management

The FIE's management activities have continued at a steady pace.

The Executive Committee met on the following dates:

12 February 2022 by videoconference  
2 March 2022 by videoconference  
8 March 2022 by videoconference  
28 March 2022 by videoconference  
8 April 2022 by videoconference  
28 April 2022 by videoconference  
28 May 2022 in Lausanne (SUI)  
17 July 2022 in Cairo (EGY)  
16 August 2022 by videoconference  
18 August 2022 by videoconference  
23 August 2022 by videoconference  
17 September 2022 by videoconference  
25 November 2022 in Lausanne (SUI)

The Commissions and Councils met on:

22 January 2022 by videoconference  
24 and 25 of June 2022 by videoconference

The Veterans' Council met by videoconference on:

2 June 2022 to elect the President of the Council  
Mr. Benoit Pincemaille (FRA) has been elected.

The Refereeing Commission met on:

11-13 July 2022 in Cairo (EGY)

The Athletes Commission met by videoconference on:

28 September 2022 to elect the President of the Commission  
Mr. Ruben Limardo Gascon (VEN) has been elected.

The ordinary 2022 Congress of the FIE was held on the 26 November 2022 in Lausanne (SUI).

**The Executive Committee was consulted 16 times** by e-mail when an urgent decision was required.

The decisions taken have been regularly communicated to the FIE members through **21 Information letters** and **5 Urgent letters**. These letters, as well as their annexes, were emailed to national federations, Members of Honour, and Members of the Executive Committee.

**22 changes of nationality** were accepted.

## 1.2 Refereeing



### 1.2.1 REFEREEING EXAMINATIONS

Venue	Date	Jury	Weapon	Candidates	Pass
Hammamet (TUN)	03-07.09.2022	Olga Cojocari Marius Florea Aida Khasanova Irina Knysch	F E S	Foil: 17 Epee: 15 Sabre: 12	Foil: 3 Epee: 5 Sabre: 3
San José (CRC)	17-22.09.2022	Olga Cojocari Salah Ferjani Aida Khasanova Irina Knysch	F E S	Foil: 30 Epee: 24 Sabre: 10	Foil: 8 Epee: 5 Sabre: 5
Budapest (HUN)	24-29.09.2022	Olga Cojocari Salah Ferjani Marius Florea Irina Knysch	F E S	Foil: 19 Epee: 21 Sabre: 10	Foil: 15 Epee: 12 Sabre: 8
Kuwait City (KUW)	01-06.10.2022	Amgad Badawi Olga Cojocari Chang-Gon Kim Irina Knysch	F E S	Foil: 24 Epee: 24 Sabre: 12	Foil: 11 Epee: 8 Sabre: 5

### 1.2.2 RENEWAL OF LICENSES

Venue	Date	Jury	Weapon	Candidates	Pass
Hammamet (TUN)	03-07.09.2022	Olga Cojocari Marius Florea Aida Khasanova Irina Knysch	S	Sabre: 1	Sabre: 1
Budapest (HUN)	24-29.09.2022	Olga Cojocari Salah Ferjani Marius Florea Irina Knysch	E S	Epee: 1 Sabre: 1	Epee: 0 Sabre: 1
Kuwait City (KUW)	01-06.10.2022	Amgad Badawi Olga Cojocari Chang-Gon Kim Irina Knysch	F E S	Foil: 6 Epee: 2 Sabre: 1	Foil: 6 Epee: 1 Sabre: 0

## 1.3 Antidoping

### 1.3.1 CONTROLS

Antidoping measures were continued throughout the period and one antidoping rule violation occurred.

Under the FIE Testing Authority, 395 in-competition tests and 85 out-of-competition were performed. 474 urine tests and 6 blood tests were performed.

### 1.3.2 CLEAN SPORT EDUCATION

In cooperation with International Testing Agency, the FIE provided one-hour, interactive anti-doping webinars available to all athletes, coaches, and officials, prior to the Junior and Cadet World Championships and prior to the Senior World Championships.

The webinars took place respectively:

on March 12 and March 26, 2022 (total number of participants: 118)

on June 28 and June 29, 2022 (total number of participants: 69)

The programmes were presented in English, French and Spanish and covered key clean-sport topics including prohibited substances, medications and supplements and therapeutic-use exemptions (TUEs).

The webinars were presented by the ITA, by Jeremy Summers, President of the FIE Medical Commission and Dr Sabrina Halaimia, Member of the FIE Medical Commission. Attendees received an official certificate of participation as well as a PDF of the presentation and links for useful related resources.

Furthermore, the International Testing Agency (ITA), in partnership with the FIE, presented five multi-language webinars addressing anti-doping and Clean Sport principles, information and practices for athletes, coaches and federations.

These Clean Sport webinars were part of the FIE educational programmes, and all FIE athletes and coaches have been highly encouraged to participate in all sessions; for those who attended, a certificate of completion was awarded. A total of 124 participants registered and participated in the webinars.

The programmes, presented in English with simultaneous interpreting in Arabic, Spanish, French, Russian and Chinese, included the following topics at the following dates and times:

- Introduction to Anti-Doping  
Overview of the system, rights, and responsibilities, ADRVs  
Nov. 10, 1400-1500 CET
- The Doping Control Process  
Testing procedures (urine & blood) and ABP  
Nov. 17, 1400-1500 CET
- Medications, Supplements, Prohibited List and TUEs  
Including the principle of strict liability  
Nov. 24, 1400-1500 CET

- Principles and Values of Clean Sport  
Sanctions, consequences and speaking up  
Dec. 1, 1400-1500 CET
- Out-of-Competition Testing  
Requirements of RTP/TP, whereabouts, use of ADAMS  
Dec. 8, 1400-1500 CET

## 1.4 **Media - Digital, TV and Magazine**

### 1.4.1 **FIE MEDIA IN 2022**

During 2022, the FIE continued to increase its communication through multiple media platforms include its website, magazine (both online and printed issues) and social channels of Twitter, Facebook, Instagram, and YouTube. The media coverage on signature events (Senior World Championships and Grand Prix) resulted in fruitful outcomes that guaranteed the continuous growth of digital channels.

The FIE Grand Prix staged six events in 2021-2022 season, including 11-13 November 2021 in Orleans, 28-30 January 2022 in Doha, 04-06 March 2022 in Budapest, 29 April 01 May 2022 in Cairo, 13-15 May 2022 in Incheon and 20-22 May 2022 in Padua.

The partnership with Eurosport and collaboration with global rightsholders has driven the growth of our global audience and media exposure.

### 1.4.2 **DIGITAL CHANNELS**

2022 was the first year following the Tokyo 2020 Olympics, and some metrics experienced anticipated post-Olympic decline to some degree. However, as the Senior World Championships (Cairo 2022) were held for the first time since the pandemic, as well as six Grand Prix events being staged, the FIE managed to keep all the digital channels growing robustly by fully leveraging these events. In addition, some initiatives such as World Fencing Day and Donate Your Fencing Gear also brought abundant content for non-competition coverage.

Through a promotional collaboration with Eurosport, the FIE digital campaign on the Eurosport website and application generated 39.3 million impressions.

During Cairo 2022, the videos produced by ICARUS provided with high-quality content for the event coverage.

Below are some key facts:

#### Website

In 2022, the FIE website reached 8.9 million page views, increasing by 48.3% (six million in 2021); it was visited by 850K million new users (1.1 million in 2021) and received 2.5 million sessions, increasing by 25% (2 million in 2021).

Among all countries/regions, USA (13%), Hong Kong China (9.6%), China (8.6%), France (7.6%) and Italy (5.5%) were the top five with the most users. The ranking was the same for new users.

#### YouTube

In 2022, the FIE YouTube channel experienced 4.6 million views, 21% more than 2021. The viewing time was 557K hours, a 46% increase. Even while the 767K video views represented 49% less than 2021, the 3.9 million live views were 66% more for the same period.

With 10K new subscribers added, the subscriptions reached 84,854 by the end of 2022, a 13% increase.

#### Facebook

In 2022, the FIE Facebook account received 29 million impressions and a reach of 11 million, a decrease of 19% and 53%, respectively. But the engagement reached 641K, a 21% increase. The number of followers reached 131,569, with 5.4K new followers added.

#### Twitter

In 2022, the FIE Twitter account received 1.47 million impressions (a 66% decrease) and engagements of 55K. The number of followers reached 22,426 with 1.6K new followers added.

#### Instagram

In 2022, the FIE Instagram account experienced 11 million impressions, 8.9 million reach and 872K engagements, a decrease of 26%, 29% and 31.5%, respectively. With 26K new users added, the total amount reached 98K by the end of 2022.

#### During the Cairo 2022 World Championships

The FIE website had 684K page views and 213K sessions, with 68K new users visiting the site.

The YouTube channel had 1.7 million views and 2.8K new subscribers. "The FIE YouTube channel aired by far the most content – 362 hours of broadcast time", according to Nielsen analytics.

- Facebook received 5.1 million impressions, a 2.3 million reach with 158K engagements
- Twitter had 244K impressions and 12K engagements
- Instagram received 1.7 million impressions, 1.4 million reaches with 144K engagements

The decline of some metrics, such as impressions and engagements, was expected due to the expected post-Olympic period, but there were still some surprises from Facebook, YouTube and the FIE website –for example, livestreaming on YouTube obtained more views than 2021. In general, growth was observed on all the channels, and the strategy of focusing on the commitment and interaction of athletes and the public on social media continues.

### **1.4.3 TELEVISION**

#### Grand Prix Events

(\* for the Grand Prix, the metrics of the "2021-2022 season" include Orleans GP in Nov 2021 but not the Orleans GP in Dec 2022)

The rightsholders include the Olympic Channel, Eurosport (tv) and PCCW (streaming).

FIE Grand Prix broadcasting accumulated an audience of 18.24 million viewers, including the top-five markets by cumulative audiences: France (8.3 million), Hungary (5 million), Germany (2 million), Russia (0.7 million) and South Korea (0.6 million). Grand Prix events total broadcast time reached 984.5 hours while visibility reached 478 hours. Eurosport channels across European countries top 10: Estonia, Iceland, Sweden, Finland, Denmark, Belgium, Hungary, Norway, France, and Switzerland contributed to the major segments.

Grand Prix events received 256 million impressions, with 62 million of them coming from France (the most among all countries) and France 3 (57.3 million), the most of all TV channels.



#### Cairo Senior World Championships

Cairo 2022 received nearly 148 million audience views via the FIE's YouTube channel, Olympic Channels and rightsholders in multiple countries (Brazil, China, Colombia, Egypt, France, Germany, Hungary, Italy, Japan, Poland, Russia, South Korea, Spain, Ukraine, USA). The top five markets by total audiences included Italy (50.2 million), China (27.7 million), France (24.8 million), Japan (15.7 million) and South Korea (10.29 million). China's CCTV5 topped all TV channels as it contributed a 27.7 million total viewing audience.

Cairo 2022's total broadcast time reached 1633 hours, while visibility reached 3410 hours. The top five countries/regions, in terms of total broadcast time, included Italy (56.5 hours), Belgium (56 hours), Malaysia (47 hours), Pan-Asia (47 hours) and Hungary (44 hours).

The event obtained 1.91 billion impressions in total, with Italy (303.5 million) accounting for the largest share, followed by China (93 million), Hungary (84 million), France (63 million) and Egypt (59 million). Among all TV channels, Rai Sport+ HD and CCTV5 were the top two contributors, providing 153 million impressions and 93 impressions, respectively.

#### Eurosport

In the 2021-2022 season, FIE events (Grand Prix events, European Championships, World Championships) had a duration of 157 hours, 6 minutes for global TV broadcasts on Eurosport 1, Eurosport 2 and Eurosport Asia. 150 TV spots recorded 56.1 million impacts on Eurosport 1&2, reaching 13.6 million unique viewers.

### **1.4.4 OFFICIAL 2022 FIE PRESS RELEASES**

In 2022, the FIE continued direct communication with the press and other interested parties subscribing to official FIE news, publishing and distributing with more than 50 press releases to media and press worldwide. This represents more than 168,000 individual emails sent with FIE news and information about events, projects, and other newsworthy bulletins.

### **1.4.5 DIGITAL MAGAZINE – ESCRIME XXI**

In 2022, with three issues (No.120-122) published, the online magazine received 3.6K page views, a slight decrease compared with 2021 (3.9K). The average time on each page was 1min 30s, an increase of 1 minute, 19s from 2021.

### **1.4.6 CHANGES & EVOLUTION**

In 2022, the FIE started to consider improved ways to utilise media content as well as protecting our rights. As a result, it was decided to launch in 2023 a new image hub that will be a library for all FIE photos, including a monetising feature, and to launch an OTT platform that will be the hub for displaying and storing FIE videos. Both programmes are in process.

By the end of 2022, about it was decided to consider an alternative to the digital magazine to increase exposure and reach to readers worldwide, and this programme is in process.



## 1.5 International activities of the FIE

The FIE participated in the following international meetings:

- **Paris 2024**, fencing competitions, weekly online meetings.
- **Paris 2024**, On Location, Hospitality, 3 February, Lausanne (SUI).
- **IOC and LA2028**, IF consultation LA28 sports programme, 13 April, online.
- **ASOIF**, Commercial workshop, 4 May, Lausanne (SUI).
- **The SPOT**, 17-18 May, Lausanne (SUI).
- **GAISF**, Statutory General Assembly, 20 May, Virtual.
- **ASOIF**: ASDEG Forum, 24-25. May, Lausanne (SUI).
- **IOC**, informational Webinar on Framework for Fairness, Inclusion and Non-Discrimination, 15 June, online ASOIF, 46th General Assembly, 8 June, Lausanne (SUI).
- **Catalan Fencing Federation**, Gala on the centenary, 3 July, Message of the Interim President read at the event.
- **Commonwealth Fencing Federation**, 2022 Commonwealth Fencing Championships, 8-11 August, London (GBR).
- **AIMS**, Presentation of United Through Sports World Youth Festival and Conference, 2 September, virtual.
- **Paris 2024**, technical visit fencing, 5-6 September, Paris (FRA).
- **IOC**: Meeting with the IOC President, Mr. Thomas Bach, 12 September, Lausanne (SUI).
- **IOC**: Consultation call of the IOC President with the IFs, 14 September, online.
- **IOC**, policy approach for inclusion, 21 October, online.
- **Signing of the MOU between FIE and ISF**, 28 November, Lausanne (SUI).
- **SportAccord**, IF Forum 2022, 28-29 November, Lausanne (SUI).
- **ASOIF**: Medical and Science Workshop, 28-29 November, Lausanne (SUI).
- **GAISF**, Extraordinary General Assembly, 29 November, Lausanne (SUI).
- **Olympic Museum**, Presentation of the collections from the Tokyo 2020 and Beijing 2022 Games, 7 December, Lausanne (SUI).

Lausanne:

- IF seminar "How to create plans to measure and reduce carbon footprints in sport events", 3 May, Lausanne (SUI).
- IF seminar "How to foster a safe and inclusive environment for all: Safe Sport's best practices for International Sports Federations, 8 November, Lausanne (SUI).

## 1.6 World Fencing Day 2022

The sixth-annual World Fencing Day, which took place on Saturday, September 10, has given fencers and everyone in the global fencing family the opportunity to celebrate this year's theme, "Fencing is for Life". By reaching out to people and communities worldwide, members of fencing have communicated its timeless and enduring qualities—a sport that fills the heart, mind and soul with a positive and powerful energy that becomes forever motivational and illuminating.

Every member of the Fencing Family had the opportunity on World Fencing Day, to convey how being involved in fencing becomes a natural and essential part of one's personal identity, giving strength and shaping each person's life and future.

With global support for World Fencing Day, more than 4,500 media tags across multiple social media platforms expressed a diversity of fencing perspectives, activities, and postings from 65 countries and reaching more than 130,000 accounts, using their favourite platform with the following tags:

#FencingisforLife #worldfencingday2022

The "Fencing is for Life" theme resonated around the world as a message of inspiration and life experience, a perennial sport that has endured the ages and will continue to do so.



# Webinars



## 1.7 FIE Safeguarding trainings

### 1.7.1 WEBINAR FOR MEMBERS OF THE FIE EXECUTIVE COMMITTEE, COMMISSIONS, COUNCILS AND COMMITTEES.

As part of ongoing work to implement its safeguarding policy, the FIE organised a safeguarding training webinar that took place on June 23 on Zoom.

The training programme was led by the FIE safeguarding officers Georgina Usher (GBR), president of the FIE Women and Fencing Council and Samuel Cheris (USA, MH), president of the FIE Legal Commission. The objective of the event was to provide members of the Executive Committee as well as the commissions and councils and the FIE staff with a thorough understanding of safeguarding concepts and the different tools the FIE puts at the disposal of all its members to provide a sport environment free from harassment/abuse/neglect.

The session included an introduction to safeguarding in sport, an overview of the legal framework in place and a focus on the FIE safeguarding policy and procedures, with a specific emphasis on the responsibilities of the supervisors at World Cups and Grand Prix competitions to manage and report disclosures.

The webinar consisted of three parts:

- A main session
- Discussion groups
- Q&A final session

About 70 people took part in the webinar.

### 1.7.2

#### WEBINARS FOR NATIONAL FEDERATIONS

The FIE hosted two Safe Sport webinars to help federations implement, review, and improve safeguarding policies at the national level. They took place on Tuesday, Dec. 13 at 1400 CET and Wednesday, Dec. 14 at 2000 CET to provide the widest-possible reach around the world. Simultaneous interpretation in French and Spanish was provided.

Approximately 60 people attended the webinars, which were organised by the FIE and led by Georgina Usher, president of the FIE Women and Fencing Council, FIE safeguarding officer and certified IOC International safeguarding officer in sport.

The presentations included two parts:

- The definition of safeguarding, the definition of the different kinds of abuse and harassment and practical references and examples of the impact the different kinds of abuse and harassment can have and FIE, IOC and international organisations and members.
- Thorough guidelines and practical steps presented to support drafting safeguarding policies, including preparation, development, content, application, and implementation.

The FIE is committed to ensuring fencing is practiced in a safe environment, where athletes harmoniously and all the members of the FIE family are granted respect and protected from all forms of harassment and abuse.

## **1.8 Athletes Commission Election**

### **The following athletes were elected in Cairo (EGY):**

- Kharlan Olga UKR WS
- Borel Yannick FRA ME
- Kim Junghwan KOR MS
- Limardo Ruben VEN ME
- Massialas Alexander USA MF
- Guo Jessica Zi Jia CAN WF

### **The following athletes were appointed by the Executive Committee:**

- Alimzhanov Elmir KAZ ME
- Beran Jiri CZE ME
- Besbes Sarra TUN WE
- Ndolo Alexandra Malika KEN WE
- Siklosi Gergely HUN ME
- Sun Yiwen CHN WE

Ruben Limardo (VEN) was elected President of the Athletes Commission.

## 1.9 FIE Working Groups

**The Executive Committee has created the following working groups:**

### 1. Olympic Games qualification system

The group was composed of 8 members. It is responsible for analysing the qualification system to determine areas for potential improvement and ways of implementing them, then for presenting the proposals to the Executive Committee, considering the following principles:

- to maintain all the achievements made by fencing at the Olympic Games
- to comply with all the principles of the Olympic Charter and IOC guidelines
- to explore the efforts to be made and the strategy to be implemented, in order to be in a position to make realistic requests

KATSIADAKIS Emmanuel (MH, GRE), heading the group

The President of the Legal Commission: CHERIS Sam (MH, USA)

Africa: FERJANI Salah (TUN)

Asia: CHO Jong Hyung (KOR)

Europe: STOŠIĆ Vukašin (SRB)

Pan-America: MARÍN ALVAREZ Francisco Rafael (VEN)

Oceania: ELIAS Vincent (AUS)

A member of the Athletes Commission: ALIMZHANOV Elmir (KAZ)

### 2. Competitions calendar

The group was composed of 9 members. It is responsible for analysing the calendar and presenting potential improvements and reviews to the Executive Committee.

AZZI Paolo (ITA), heading the group

The Presidents of the 5 Confederations

EL HUSSEINY Abdelmoneim Elhamy (EGY)

KNYSCH Irina (RSA), President of the Refereeing Commission

MONTANO Aldo (ITA), Member of the Athletes Commission

MASSIALAS Gregory (USA), Member of the Coaches Council

### 3. Fencing and Environment

The group was composed of 9 members. It is responsible for analysing the impact of fencing on the environment and providing the Executive Committee with suggestions regarding the implementation and monitoring of individual and collective measures and a plan of measurable and sustainable actions.

DELGADO Ana Irene (PAN), heading the group

MOURAD Dr Maha, (EGY), member of the Medical Commission

BOLANOS Joyce (ISV), member of the PCM Commission

BRANDULE Baiba (LAT), member of the SEMI Commission

Five representatives of the confederations (one per continent)

Panamerican Confederation: LORCA Marcelo (CHI)

European Confederation: HALSTED Dr Clare (GBR)

African Confederation: ABDUL Zorome (MLI)

Asian Confederation: HAMZULIDA Reni (INA)

Oceanian Confederation: BAKER Matthew (NZL)

The progress reports of the working groups were sent to all member federations. The groups will continue their work in 2023.

## 1.10 FIE Awards

### 1.10.1 PRIZE FOR THE BEST REFEREE

Based on the proposal of the Refereeing Commission, the Executive Committee has designated the following best referees for 2022:

**Foil:**

1. ARMATA Gaspare (ITA)
2. SUH Sangwon (KOR).
3. FERJANI Ayoub (TUN); 3. WITKOWSKI Andrzej (POL).

**Epee:**

1. PAGHIEV Mihail (MDA).
2. KOVRIJNYKH Andrei (RSA).
3. CIVIERO Ambre (SUI); SAMEH Abd Allah (EGY).

**Sabre:**

1. MILENCHEV Vasil (BUL).
2. KOSA Miklos (HUN).
3. MARTILOTTI Luigi (ITA); 3. DOUVIS Andreas (GRE).

**The following prizes were awarded for each weapon:**

**1st:** USD 10 000

**2nd:** USD 7 000

**3rd:** USD 4 000

### 1.10.2 HALL OF FAME 2022

The following were inducted into the Hall of Fame 2022 by the FIE Executive Committee:

**Athletes Category:**

Lee KIEFER (USA)

Yiwen SUN (CHN)

Tibor PEZSA (HUN)

Romain CANNONE (FRA)

**Fencing Family Category:**

Armen GRIGORYAN (ARM)

### 1.10.3 FAIR PLAY TROPHY 2022

On the proposal of the Fair Play Council, the Executive Committee awarded the 2022 Fair Play Trophy to the following athletes:

TEJEDA Sheila Liliana (MEX)

KESZTHELY Zsombor (HUN)

## 2 ASSISTANCE OF THE FIE IN SPORT DEVELOPMENT

### 2.1 2022 Exceptional help

FEDERATION	PAYMENT EXEMPTIONS	CHF
<b>Lebanon Federation</b>	Exceptional help to support the resumption of activity, after the explosions in Beirut.	30 000
<b>Ukrainian Federation</b>	Special programme aiming at providing fencing equipment to the fencers from the Ukrainian federation who may face issues with their equipment.	50 000
<b>Total exceptional help</b>		<b>80 000</b>

### 2.2 Training camps for athletes

Two training camps were organised on the Junior and Cadet World Championships in Dubai (UAE) and the Senior World Championships in Cairo (EGY). The FIE paid all the expenses associated with these camps (air tickets, local transport, hotel, meals, experts, visa fees, entry fees) until the end of the individual competitions in the World Championships.

These camps were organised for the following purposes:

- to offer a week of intensive preparation to fencers who sometimes do not have sufficient training partners to allow them to aim for a top international level.
- to introduce these young talents to the structure and entire content of a modern training session.
- to allow them to benefit from advice from highly experienced maîtres d'armes and physiotherapist as well as acquire the determination to put this advice into practice.
- to offer them contact with the global fencing elite under the best possible conditions.
- encouraging them to redouble their efforts and inspiring them to serve as examples once they return to their training halls.

#### DUBAI

##### Dates:

Sabre: March 27 – April 1, 2022

Foil: March 30 – April 4, 2022

Epee: April 2-7, 2022

**Athletes selected:**

National Federation	First Name	Last Name	Weapon
LBA	Abubaker	ALGADI	Epee
NZL	Charles	BIOLETTI	Epee
TOG	Al Yacine	OURO-AGORO	Epee
CRO	Dorja	BLAŽIĆ	Foil
LAT	Juta	MALNIECE	Foil
SLO	Eli	MLEKUZ	Foil
CZE	Karolina	BECHYNOVA	Sabre
PER	Joel Antonio	GALVAN VARGAS	Sabre
SEN	Awa	DIOP	Sabre
SLO	Peter	KRAJNC	Sabre
SRI	Abesekara Mudiyanse	ASHANI RATHNAMALI ABESEKARA	Sabre
UAE	Hamid	ALMAAZMI	Sabre
ANG	Florinda De Carvalho	ALVARO	Epee
BAR	Sanojah Ruby	GILKES	Epee
ESA	Saul Moris	VILLACORTA PORTILLO	Epee
GUM	Anica	CAMACHO	Epee
KGZ	Akmal	MOIDUNOV	Epee
MGL	Enkhmend	BYAMBASUREN	Epee
SLO	Lars	PONIKVAR	Epee
ANT	Mikkel Keenan	JONES	Foil
IRL	Claudio	SOSA SMATRALA	Foil
TUN	Mohamed Ali	FOUCHA	Foil
UZB	Radmir	SEMENEV	Foil
GRE	Konstantina	KEFALA	Sabre
TUN	Rania	FERJANI	Sabre
UAE	Laila	ALSEIARI	Sabre



**Coaches:**

National Federation	First Name	Last Name	Weapon
RSA	Gennady	TYSHLER	Sabre
ROU	Petru	KUKI	Foil
USA	Marek	STEPIEN	Epee

**Figures:**

26 athletes from 22 countries:

6 from Africa

8 from Asia-Oceania

8 from Europe

4 from the Americas

14 women and 12 men

10 epee fencers

7 foil fencers

8 sabre fencers

## CAIRO

### Dates:

July 9-19, 2022

### Athletes selected:

Country	First Name	Last Name	Weapon
BAR	Sanojah Ruby	GILKES	Epee
KEN	Isaac	WANYOIKE	Epee
CRC	Daniel Antonio	OJEDA BUITRAGO	Epee
MGL	Batsaikhan	AMARZAYA	Epee
LBA	Abdussalam	ABUJTELA	Epee
IRQ	Muntadher Haleem	HASHIM	Epee
CMR	Marcelle Lolita	AMOUGOU NGUINA	Epee
PUR	Carlos Manuel	PADUA RODRIGUEZ	Foil
MDA	Ecaterina	GOROBET	Foil
RSA	Aphiwe	TUKU	Foil
RSA	Jacques	VILJOEN	Foil
KAZ	Galim	NURUMOV	Foil
PER	Paola Carolina	GIL PIÑERO	Foil
IRQ	Ghaith Ahmedswadi	SALEEM	Foil
VEN	Antonio Junior	LEAL PIÑA	Foil
CHI	Yolanda Beatriz	MUNOZ PINILLA	Sabre
SLO	Zorz	ZAVIRSEK	Sabre
NEP	Yonjan	PAYAS	Sabre
LBN	Bou Khalil	KARL	Sabre
DOM	Heyddys Estibalys	YSABEL VALENTIN	Sabre
JOR	Tahla Omar Khaleel	ABDALLAH	Sabre
JAM	De-Cordoba Philip	MITCHELL-ROWE	Sabre
CZE	Klara	HANZLIKOVA	Sabre
CAM	Linly	CHHAY	Sabre
COD	Makwanya Nyabileke	GRÂCE	Sabre
UGA	Charles	MUTAGWANYA	Sabre
NZL	Hamish	BULMER	Sabre

### Coaches:

LAT	Kaminski	SAMUIL	Epee
EGY	Shaimaa	EL GAMMAL	Foil
USA	Zoran	TULUM	Sabre

### Figures:

17 men and 11 women

7 epee fencers

8 foil fencers

12 sabre fencers

8 athletes from the Americas

7 athletes from Africa

9 athletes from Asia-Oceania

3 athletes from Europe

## 2.3 Oceania Fencing Master Academy (OFMA)

### Oceania Fencing Confederation (OFC) Coaching Commission

- The Commission met monthly via Zoom technology and phone during 2022 to plan and progress various OFMA projects.
- A 2022 Coach Education Plan was developed to assist the post Covid-19 restart of Fencing activities in Oceania. Two of the planned activities were an online Level 1 Foil Course and supporting Fencing New Zealand with their Olympic Solidarity Technical Course for Coaches (Foil).
- The Commission continued development of the OFMA Coach Assessor Training Course and continues to administer the operational activities of OFMA.

### OFMA Coach Education

- Under the auspices of OFMA, the OFC partnered with Global Fencing Masters (GFM) to advertise and conduct an online Level 1 Foil Course. Using a web-based learning platform, a phone app and Zoom technology, the Course was presented over 3 months to 25 Coaches from Australia, New Zealand, Fiji, Guam, and Papua New Guinea.
- With Covid-19 restrictions being lifted, the Regional Development Officer was able to travel to Guam, Brisbane, and Melbourne to conduct face-to-face review of the course content and assessments for most participants in the online Course. Coaching Commission members in New Zealand also conducted reviews and assessments at four locations.
- Fencing New Zealand (FeNZ) received funding from the IOC and New Zealand Olympic Committee for an Olympic Solidarity Technical Foil Course for Coaches. This course was also supported by the FIE. The Course was held in Christchurch from 12-20 December 2022. OFMA assisted with planning and delivery. Maître Zoltan Bernat of the FIE Coaching Academy, Budapest was the Head Coach for this extremely successful event. 33 student coaches enjoyed the benefits of his high-level fencing knowledge & experience.
- OFMA established a panel including Maître Bernat and representatives of the OFC Coaching Commission to conduct Level 2 Foil Assessments. 14 coaches chose to be assessed and were successful in gaining their Level 2 Foil accreditation. Each received a Level 2 Certificate from OFMA.
- The IOC provided FeNZ with a certificate template for the Course & all 33 participants received a personalised copy.

## 2.4 Training academies for coaches

### 2.4.1 JOHANNESBURG

Course duration: 9 February – 30 November 2021.

Graduation day: 18 November 2022.

The courses programme was prepared and organised in all three weapons by:

- Dr Gennady TYSHLER (Ph.D. in Pedagogy and Ph.D. in Sport Science), Lecturer for all three weapons.
- Dr Mikhail GALUKHIN (Ph.D. in Sport Science), Visiting Lecturer.
- Dr Alek MOVSHOVITCH, Professor of Physical Education, External Consultant for the Academy Programme.

#### 2022 Selected Students

1. Tshepo PHAKISI - South Africa
2. Martin King'ola MUSILI - Kenya
3. Yusufu Bimbu KIAMUANGANA - Angola
4. Diana Njeri MAINA - Kenya
5. Keokile KGOBERO - Botswana
6. Benedicte NSUA - Congo/Refugee
7. Refilwe MOGOTSI - South Africa

All 2022 Class students successfully finalised Academy programme and received their FIE recognised Fencing Coaching Diploma. Diplomas were delivered by the FIE Sport and Technical Director Mr Dieter Lammer.

At the graduation Ceremony each student received a complete set of the coaching equipment donated by the FIE.

### 2.4.2 BUDAPEST

Budapest Coaching Academy 2022 returned after two years of no activity due of Covid-19 Pandemic. The Academy strategy, as decided on 2016, is to open education center for coaches, where coaches from all over the world could come to learn and improve their level, so they can return home with updated and first level knowledge.

During 2022, three 3-month courses were organized:

**Sabre:** from January 17th to April 18th 2022, attended by 8 selected students (4 from Asia, 3 from Europe and 1 from Pan America), we had 2 women and 6 men.

**Epee:** from April 25th to July 26th 2022, attended by 8 selected students (6 from Europe, 1 from Asia, and 1 from Pan America), we had 3 women and 5 men.

**Foil:** from August 1st to November 1st 2022, attended by 8 selected students (6 from Asia and 2 from Europe), we had 1 woman and 7 men.

The training sessions were scheduled from Monday to Friday, 6 hours per day, for 12 weeks.

The Hungarian University for Physical Education joined the program and provided theory lessons on psychology, physiology, biomechanics and theory of sports. As part of this agreement, the University acknowledges the Academy training and awards internationally-recognized Level 2 diplomas to those Academy students who pass the final exam.

At the end of the program both practical and theoretical exam were done to demonstrate and proved learned knowledge.

The experts selected to provide the specific fencing training are renowned fencing coaches:

**Sabre:** Maître Zsolt NEMCSIK

**Epee:** Maître Bela KOPETKA

**Foil:** Maître Zoltan BERNAT

- 19 out of 24 students were experienced coaches, with more than 5 years' experience before getting into the Academy.
- All graduate students are encouraged to return to their home countries to pass their knowledge and to improve the fencing in their own countries.
- All students graduate with scores over 80%
- Almost 30% women participation, increasing the number of participation leading to a 50% equity for the next few years.

Local authorities of Budapest help to find ideal facilities to rent where coaches could learn and practices under the best conditions. Full accommodation and catering were given to students during all their course.

FEDERATION	WEAPON	NAME
USA	Sabre	Valerij KIZIK
JPN	Sabre	Mayu KUSHIHASHI
BRU	Sabre	Yoshea POERAWINATA
IND	Sabre	Surjit LANGOLJAM
FIN	Sabre	Samuli KORPIMÄKI
KAZ	Sabre	Kazbek SERKEBAYEV
AZE	Sabre	Khalid ASADOV
SRB	Sabre	Liza LÊZAIĆ SCHWEITZER
MNE	Epee	Dejan DURASCOVIC
AZE	Epee	Najaf MAHARRAMOV
FIN	Epee	Kasper ROSLANDER
CYP	Epee	Alexandros EMMANOULIDIS
GBR	Epee	Beth Gina DAVIDSON
LUX	Epee	Veronika GONCHAROVA
HKG	Epee	Shan LO
ARG	Epee	Sergio VILLAMAYOR
SRB	Foil	Andela KOSTIC
IRI	Foil	Mohammad MIRMOHAMMADI
ASA	Foil	Essa ALMUQABQAB
LBN	Foil	Wissam DAOUD

<b>IND</b>	Foil	Kumar ASHOK
<b>THA</b>	Foil	Pongipat ONTAM
<b>HKG</b>	Foil	Chi Ming Andy LAM
<b>HUN</b>	Foil	Mate BERNAT

Total number of participants: 24

Total number of countries: 19

## 2.5 Olympic Solidarity (OS)

### OLYMPIC SCHOLARSHIPS FOR COACHES

The following coaches were awarded an OS scholarship:

OLYMPIC SCHOLARSHIPS FOR COACHES			
<b>DE CARIA GONZALEZ</b> Franco Andrés	10.2022-03-2023	Centro de Alto Rendimiento, Spain	URU
<b>DE SILVA</b> Seekku Bague Manula Shivantha	10.2022-12.2022	University of Physical Education, Hungary	SRI
<b>Sagara GARIBOU</b>	04.2022-09.2022	PAISAC, CANADA	MLI

### OLYMPIC SCHOLARSHIPS FOR ATHLETES

The following athletes were awarded an OS scholarship:

PAYAS Yonjan **NEP**  
 SIADI YABUYA Yane **COD**  
 BOYER Charlotte Kenia Coline **HAI**  
 PEREZ MAURICE María Belén **ARG**  
 ABUJTELA Abdussalam **LBA**  
 DEMBELE Aichata **MLI**  
 MAJALI Roa'a **JOR**  
 GIANNOTTE Flavio **LUX**  
 PAKDAMAN SAYED Ali Esmailzadeh **IRI**  
 BAZADZE Sandro **GEO**  
 ALVARES DE OLIVEIRA Victor **CPV**  
 CHEUNG Ka Long **HKG**  
 BATSAIKHAN Amarzaya **MGL**  
 PROESTAKIS ORTIZ Katina **CHI**  
 LEHIS Katrina **EST**  
 LEE Simon Rennie **SGP**  
 LEE Kar Yi Jolie **SGP**  
 VIVEROS Monserrat **PAR**  
 ANDRIAMAMONJY Jolan Carla **MAD**  
 CATANTAN Samantha Kyle **PHI**

## TECHNICAL COURSES FOR COACHES

The following technical courses for coaches were carried out:

TECHNICAL COURSES FOR COACHES		
COL	LANDI Lucio (ITA)	10.01.2022-13.02.2022
IRI	PISETSKII Boris (RUS)	20.01.2022-20.01.2022
ISR	MAZZONI Angelo (ITA)	31.10.2022-04.11.2022
NZL	BERNAT Zoltan (HUN)	11.12.2022-23.12.2022
GRE	LEVAVASSEUR Daniel (FRA)	19.12.2022-23.12.2022
VIE	PETRU ADALBERT Kuki (ROU)	28.11.2022-05.12.2022

## DEVELOPMENT OF NATIONAL SPORTING STRUCTURES (DNSS)

The following activity for the Development of National Sporting Structure was carried out:

DEVELOPMENT OF NATIONAL SPORTING STRUCTURES (DNSS)		
MLI	ZOUARI Mohamed Hassene (TUN)	19.12.22-29.04.23

## 2.6 Equipment aid

The criteria used to perform the analysis and allocate the equipment were as follows:

- Specific requirements: participation in FIE competitions or competitions other than the FIE ones.
- Federations in need of equipment for organising important competitions (Olympic Games, World Championships, Grand Prix, World Cup, Continental Championships, Regional Games, Universiades).
- Special cases.

The budget for 2022 was 600'000 CHF.

The FIE awarded equipment to be received by 103 federations: 25 in Europe, 25 in Asia, 3 in Oceania, 25 in the Americas and 25 in Africa. The federations received equipment worth CHF 6000.

The operations for the equipment distribution started in August 2022.

## 2.7 Donate your fencing gear.

After a stop of two years, due to the Covid-19 pandemic, the FIE was able to resume the solidarity programme "Donate your fencing gear".

Two collection events were carried out in Dubai during the Junior and Cadet World Championships and in Cairo during the Senior World Championships.

In total, over 300 pieces of equipment were collected and examined by the dedicated SEMI delegates, respectively Samer Hashem (EGY) and Baiba Brandule (LAT).

5 countries, having previously presented solidarity and grassroots projects, received equipment:

- Brazil
- Colombia
- Guam
- Kenya
- Paraguay

All the donors received a certificate in recognition of their contribution and generosity and their pictures, when permitted, were published on the FIE social media.

## **2.8 Assistance with athletes' participation programme 2022**

Since 2009, the FIE has implemented a special aid programme for the athletes from federations participating in senior regional championships and the World Championship (junior and senior).

For each national federation taking part, all the confederations received a subsidy intended to cover expenses (plane ticket and hotel) for an athlete entering for:

- The Junior and Cadet World Championships
- The Senior Zonal Championships
- The Senior World Championships

## **2.9 Assistance for Confederations**

All confederations received an annual subsidy and a subsidy for their administrative expenses.

The confederations employing a sport director received an additional subsidy to pay this director's salary.

## **2.10 Assistance for competition organisers**

National federations having organised an FIE competition (senior World Cup, Grand Prix) and applying, received a subsidy of CHF 3 000 to cover the cost of video refereeing.

The FIE subsidised the cost of the Swiss Timing equipment for the Grand Prix events and Senior World Championships.

## **2.11 Fencing Equipment Repair Course in South Africa**

A workshop focused on fencing weapons repair was held at the FIE Coaching Academy in Johannesburg, South Africa from Sept. 22 – 26, with attendees participating from five African nations. The FIE invited Mr. Gilles Martinage (FRA) to lead the course.

Some of the topics covered in the programme included: an overview of electrical signalling systems (e.g., in cables, reels, scoring apparatus, pistes); general basics regarding electricity and electrical equipment; specifics of electrical circuits in epees and foils; diagnosing and localising various systemwide failures, from weapon to scoring machine; fitting weapons with new blades and ensuring they are secure, wired and operating correctly; details about foil and epee points, including proper weights, connections and operation as well as how to diagnose problems; and weapons control operations and logistics at a competition, including rules, organising weapons control and ensuring safety measures.



“The trainees were particularly attentive and eager to learn”, said Mr. Martinage. “They made the most of the numerous practical exercises to acquire the initial know-how necessary for the maintenance of the various types of equipment.”

The topics covered included theoretical and practical elements and included recalls in connection with FIE rules.

List of the trainees who all successfully completed the course:

LAST NAME	FIRST NAME	COUNTRY
NSUA	Benedictine	CGO
MUSILI	Martin	KEN
NJERI MAINA	Diana	KEN
MOGOTSI	Refilwe	RSA
PHAKISI	Sthenmbele	RSA
KAIMUANGANA	Yusufu	ANG
KGBERO	Keokile	BOT

## 2.12 Confederations activities

### 2.12.1 EUROPEAN FENCING CONFEDERATION

#### 2.12.1.1. ORGANISATION OF EUROPEAN CHAMPIONSHIPS

**a)** Cadet and Junior European Championships were held in Novi Sad (Serbia) from 26.02 to 07.03.2022.

**Participants in Cadets:**

- Individual: 493 from 36 countries
- Team: 126 teams from 35 countries

**Participants in Juniors:**

- Individual: 515 from 38 countries
- Team: 98 teams from 31 countries

**b)** U-23 European Championships were held in Tallinn (Estonia) from 27 to 31.05.2022.

**Participants:**

- Individual: 343 from 31 countries
- Team: 66

**c)** Senior European Championships were held in Antalya (Türkiye) from 17 to 22.06.2022.

**Participants:**

- Individual: 435 from 37 countries
- Team: 91

#### 2.12.1.2 EFC LICENCES 2021/2022 SEASON

**d)** License's holders from European countries 4664 from 43 countries.

**e)** License's holders outside Europe: 331 from 29 countries.

#### 2.12.1.3 REFEREES WITH EFC C LICENSE:

- Sabre: 20 referees from 12 countries
- Foil: 41 referees from 17 countries
- Epee: 50 referees from 21 countries

#### 2.12.1.4 EFC REFEREES MASTER LIST - 2022

- 72 referees from 26 countries

#### 2.12.1.5 EFC WEBINARS

**a)** EFC Referees Project: FIE Sabre Referees – Zone Europe

This Project was a continuation of the very successful previous EFC Referees Projects "European Sabre Referees" and "GET READY FOR THE NEW SEASON".

Participants: 68 referees from 11 countries

**b)** Webinar dedicated to member federations affiliated in the EFC.

### 2.12.1.6 CADET CIRCUIT 2021/2022 SEASON

The season 2021 – 2022 was heavily attacked by the pandemic period caused by Covid-19 virus spread at all over the World. Thus, statistics are quite different from previous years and are not reflecting a real situation of cadet fencing in this time. Several of traditional organisers had to withdraw and only very limited competitions could be running.

Even if not fully realistic, here are some statistics from competitions carried out in 2021 – 2022.

**Total of fencers on pistes in 2021 – 2022 season: 6364 fencers.**

Grand total of participants in 2019 – 2020: 10.029 fencers

European federations: AUT, AZE, BEL, BLR, BUL, CRO, CYP, CZE, DEN, ESP, EST, FIN, FRA, GBR, GEO, GER, GRE, HUN, IRL, ISR, ITA, LAT, LTU, LUX, MDA, MKD, MON, NED, NOR, POL, POR, ROU, RUS, SLO, SRB, SUI, SVK, SWE, TUR, UKR (40 countries)

Out of Europe federations: ALG, ARG, AUS, BRA, CAN, CHN, CRC, ECU, EGY, HKG, JOR, KSA, MAS, PER, PHI, QAT, SGP, TPE, TUN, USA, UZB (21 countries)

### 2.12.1.7 WINNERS OF THE CIRCUIT CADET CUP IN 2021/2022 SEASON

- Men's Foil Cadets: **HELMY-COCOYNACQ Adrien (FRA)**
- Women's Sabre Cadets: **SPIESZ Anna (HUN)**
- Men's Sabre Cadets: **ASLAN Tolga (TUR)**
- Women's Epee Cadets: **CONRAD Emili (UKR)**
- Men's Epee Cadets: **BROOKE Alec (GBR)**
- Women's Foil Cadets: **AUDIBERT Alicia (FRA)**

### 2.12.1.8 TEAM WINNERS OF THE CIRCUIT CADET CUP IN 2021/2022 SEASON

- Men's Foil Cadets **POLAND (POL)**
- Women's Sabre Cadets: **TÜRKIYE (TUR)**
- Men's Sabre Cadets: **TÜRKIYE (TUR)**
- Women's Epee Cadets: **ITALY (ITA)**
- Men's Epee Cadets: **ITALY (ITA)**
- Women's Foil Cadets: **TÜRKIYE (TUR)**

### 2.12.1.9 NEW PRESIDENT AND COMPOSITION OF THE BUREAU AND EXECUTIVE COMMITTEE

1. Giorgio Scarso - President
2. Jacek Slupski – General Secretary
3. Etienne Van Cann – Vice-President, President of the SEMI Commission/ President of the Legal Commission
4. Nuala McGarrity – Treasurer, President of the Medical Commission
5. Gabor Boczko – President of the Referees Commission
6. Nikolay Mateev – President of the Competition Commission
7. Metaxia Smaili – President of the Women and Sport Council/President of the Veterans Council
8. Ana Valero – Collantes – President of the promotion and Marketing Commission
9. Vadym Guttsait – Comex member
10. Hilary Philbin – Comex member
11. Irem Karamete-Baldini – President of the Athletes Commission

#### *2.12.1.10 EUROPEAN CLUB OF CHAMPIONS IN TEAMS IN CAGLIARI AND HEIDENHEIM*

Number of countries 25

**Number of teams:**

- Women's foil: 8
- Men's foil: 7
- Women's epee: 16
- Men's epee: 19
- Women's sabre: 7
- Men's sabre: 7

#### *2.12.1.11 CREATION OF SOLIDARITY PROGRAMME*

New President presented new project "European Solidarity Club".

Purposes:

Encourage technical, cultural, organisational and management exchange among the European Federations for the benefit of the technical growth of athletes, coaches, competition officials and managers by organising stages, meetings, and training through the implementation of two methods.

#### *2.12.1.12 EFC CONGRESSES IN 2022*

- Extraordinary Congress: 31.05.2022
- Annual Congress: 16.06.2022
- Extraordinary Congress: 01.10.2022

## **2.12.2**

### **ASIAN FENCING CONFEDERATION**

- Shared assistance & support for small, developing, and leading federations.
- Organising joint academic training seminars for coaches, referees, and for the administration of National Fencing Federations of Asia and Oceania.
- Organising joint training camps for talented athletes and coaches of National Fencing Federations from Asia and Oceania.
- Introduction of new ideas to attract children to fencing using modern electronic kits for children's fencing.
- Participation of hundreds of thousands of children in fencing classes in Asia with the help of a fun innovative interactive children's online fencing encyclopaedia.
- Development of a special project of Asian championships for children from 9-10 years old, and 11-12 years old.
- Development of high-performance fencing in Asia, to attain the leading position in the world.
- Development, cooperation, and mutual assistance among the African and Pan American Confederations within the framework of the signed agreement.
- Expansion of employing professional in the field of fencing and the support of fencing-related professions.

The Asian Fencing Community with high hopes and new leadership, that will grow the Asian Fencing family towards a great future and continued success in their efforts.

#### *2.12.2.1 FIE COMPETITIONS IN ASIA*

In 2022, 16 FIE competitions were organised.

- 1 Satellite in Singapore
- 8 Junior WC (1 THA, 4 UZB, 1 BRN, 1 KAZ, 1 IRI) 3 Senior WCs (1 UAE, 1 CHN, 1 JPN)
- 1 Junior and Cadet Fencing Championship in Tashkent, 1 Senior Asian Championship in Korea
- 2 GPs

Also, in Kuwait, U23 was successfully organised where more than 23 countries participated.

#### *2.12.2.2 CONFERENCES AND SEMINARS IN THE ASIAN REGION*

With new initiatives and framework for the development and promotion of fencing globally, the Fencing Confederation of Asia successfully organised significant events in 2022:

- FCA General Assembly in Dubai, where important decisions were taken for the growth and development of the FCA
- Intercontinental Conferences in Tashkent, where a cooperation between 3 Confederations; Pan- American, African, and Asian was signed.

#### *2.12.2.3 NEW REFEREES IN ASIA FOR FCA IN INTERNATIONAL CATEGORY*

From 1st to 6th of October 2022, Kuwait City welcomed 70 candidates from 14 countries, who were entered in the FIE refereeing exam.

#### *2.12.2.4 2022 FCA REFEREES' EXAMS CATEGORY C IN DUBAI*

50 participants from 11 Asian countries took part in these seminars and exams. 11 female referees also took part in these seminars and exams.

Referees successfully received category C- In foil - 21 licenses, In epee - 29 licenses and in sabre - 10 licenses.

#### *2.12.2.5 INTERNATIONAL SEMINAR IN MALAYSIA, 2022, WITH FOCUS ON EMBRACING WOMEN AS FENCING REFEREES*

In August 2022, the International Women's Judicial Seminar and Group C Exams were held in Kuala Lumpur, Malaysia, which was attended by more than 61 potential women referees. This proved to be major progress in the education of a new courts in the Asian continent as well.

#### *2.12.2.6 FIE COACHING COURSES*

The main goal of these seminars is to increase the level of knowledge in the preparation of top-level athletes. It is very important for the Asian Fencing Confederation to increase the quality of the training system for the developing National Federations/Associations and have more high-level athletes in the region. The following courses were organised:

- EPEE - September 18-28, 2022, Ulaanbaatar, Mongolia
- SABRE - October 17-27, 2022, Bangkok, Thailand
- FOIL - October 24 – November 2, 2022, Tashkent, Uzbekistan

More than 70 coaches from several developing countries in Asia participated in these international courses.

#### *2.12.2.7 INTERNATIONAL PHILANTHROPIC MISSION*

FIE maraging blades, fencing bags, and FIE masks were awarded to 17 Asian countries. This mission was a vital support for the development of National Federations.

The President of the Asian Fencing Confederation H.H. Engr. Sheikh Salem Sultan Al-Qasimi, presented the fencing equipment to the National Fencing Federations during the JCAFC 2022 in Tashkent.

#### *2.12.2.8 DEVELOPMENT OF FIE AID PROGRAMME*

In the framework of FIE AID programme 2022, 25 Asian Fencing Confederation countries were selected to receive the equipment for fencing as per FIE competition standards. Some of the countries received pistes for competitions upon their request while some received the FIE maraging blades and others received FIE full competition uniforms.

### **2.12.3 PAN AMERICAN FENCING CONFEDERATION**

#### *2.12.3.1 PAN AMERICAN CADET AND JUNIOR CHAMPIONSHIPS 2022*

They were held in the city of Lima, Peru, from 21 to 27 March 2022. After two years without holding this event due to the pandemic, the activity was resumed with the dynamic participation of young athletes from our continent. The competitions were held in the National Sports Village (VIDENA) and had more than 300 athletes in the cadet and junior categories.

#### *2.12.3.2 PAN AMERICAN SENIOR CHAMPIONSHIP 2022*

In the city of Asunción, Paraguay, from 2 to 8 June 2022, the 2022 Pan American Senior Championships were held, which was also the qualifying event for the Santiago 2023 Pan American Games. The competitions took place in the facilities of the central sports centre of the Olympic Park in Asunción.

#### *2.12.3.3 PAN AMERICAN CHILDREN'S AND VETERANS' CHAMPIONSHIP 2022*

From 22 to 26 August 2022, the Pan American Children's and Veterans' Championships took place in Lima, Peru,. After 2 years, the competitions in these categories were resumed. The participation was massive in this event.

#### *2.12.3.4 2022 COACHES' COURSES*

During 2022, 3 coaches' courses were held in the Pan American zone. All 3 were held in Lima, Peru.

SABRE: From 9 to 20 August the sabre coaches' course was held with master Zoran Tulum (USA), the venue on this occasion was the Punta Roca complex in Lima. Twenty-one coaches took part and made the most of the teachings and experiences of an Olympic coach.

FOIL: from 6 to 17 October the course for foil coaches was held in the city of Lima, on this occasion the venue for the activities was in the VIDENA (National Sports Village of Peru), 19 coaches saw activity from the hand of the master Petru Kuki (ROU) with his extensive experience in the training of athletes and coaches.

EPEE: From 10 to 20 December 2022, the epee course was held at the Club Terrazas, Lima. For this last course the presentation was given by master Jerzy Konczalski (POL), with a long record as a coach and now as a teacher; he shared with all the participants his experience at competitive and training level. There were 20 participants who had the opportunity to acquire the master's knowledge.

#### *2.12.3.5 CPE 2022 CONGRESS*

In Panama City, Panama, the annual Pan American Congress was held on 22 October 2022, at the Hotel Las Americas Golden Tower, where the presidents and delegates of the affiliated national federations met. An atmosphere of friendship, cordiality and enthusiasm reigned to prepare for the upcoming activities. The president, Mr. Vitaly Logvin interacted with all delegates to work together on all projects and challenges for 2023.

### **2.12.4 OCEANIA FENCING CONFEDERATION**

#### *2.12.4.1 DEVELOPING NEW FEDERATIONS IN THE PACIFIC*

The OFC currently has six full members (American Samoa, Australia, Guam, New Zealand, Papua New Guinea, and Samoa) and two Associate Members (Tahiti and New Caledonia).

Post-COVID travel restrictions, we have continued to support the Fiji Fencing Federation by including two coaches in our coach education activities and assisting with future planning.

#### *2.12.4.2 DEVELOPMENT ACTIVITIES AFTER THE ARRIVAL OF COVID-19*

- Due to the Covid-19 pandemic in the first half of the year, the OFC adapted its mode of delivery to online activities as it did in 2020 and 2021.
- The OFC Annual General Meeting was held in July on Zoom and attended by the Mr Katsiadakis, Interim President of the FIE. Five OFC Board meetings were also held on Zoom.
- OFC Administration was carried out on email, Skype, and phone, with regular meetings between the OFC President, Regional Development Officer and the OFC Secretary/Finance Officer.
- The OFC Coaching Commission met online fourteen times using Zoom.
- As the Regional Development Officer was not able to travel to carry out his usual activities face-to-face with member federations, the OFC and the Oceania Fencing master's Academy (OFMA) partnered with Global Fencing Masters (GFM) to carry out a three-month trial of the GFM Level 1 Online Foil Course in order to investigate remote learning opportunities for coaches. 25 student coaches from Australia, New Zealand, Guam, PNG, and Fiji participated and the trial was deemed to be very successful.
- The online trial was followed up in the second half of 2022 with face-to-face content review and assessments of the trainee coaches which were funded by a grant obtained from the Organisation for Sports Federations of Oceania (OSFO).
- A very successful Referee Development Seminar was held in Auckland, New Zealand from 18 to 20 October, delivered by the President of the FIE Refereeing Commission, Ms Irina Knysch. Thirty-nine (39) people participated across three sessions, plus 16 participated online. About 20 of the referees were coached and mentored by Irina during the championship that followed the seminars. This had a very positive effect on the expertise and knowledge of the participants and will be very important in lifting the level of refereeing in Oceania.
- Thanks to the IOC, New Zealand Olympic Committee and the FIE, an extremely successful Olympic Solidarity Technical Course for Coaches in Foil was hosted by Fencing New Zealand in Christchurch from 11 to 20 December. The course was delivered by Maître Zoltan Bernat, Head Coach at the FIE Coaching Academy in Budapest and 33 coaches from Australia, New Zealand and Guam participated.

#### *2.12.4.3 OCEANIA CHAMPIONSHIPS*

- The Oceania Cadet Championships were held in Sydney, Australia from 1 to 2 July.
- The Oceania Veteran Championships were held in Auckland, New Zealand from 22 to 24 October.
- The Oceania Senior Championships were held in Adelaide, Australia from 25 to 30 November.

The events were attended by fencers from Tahiti, New Zealand and Australia, but we are hoping that more of our member federations will be able to compete in 2023, with the return to travel around the Pacific.

#### *2.12.4.4 PARTICIPATION IN FIE EVENTS INCLUDING THE ASIA-OCEANIA OLYMPIC QUALIFICATION TOURNAMENT*

OFC President Helen Smith, Mr Vince Elias (Australia) and Mr Matthew Baker (New Zealand) were appointed in 2022 to the FIE Working Groups on the FIE Competition Calendar, the Review of the Olympic Qualification System and Fencing and the Environment respectively.

Fencers from Oceania participated in the World and Asian Junior, Cadet and Senior Championships, the World Veteran Championships, as well as in many other FIE events and the Commonwealth Championships.

Fencers from New Zealand participated in the FIE Training Camps held before both the Junior and Senior World Championships in Dubai and Cairo.

Three Oceania referees were successful in the FCA C Licence Referee examinations held in 2022. All are hoping to continue along this path to become FIE B Category referees.

With the help of a travel subsidy from the FIE, all Oceania federations were represented either by a Delegate or Proxy at the FIE Congress held in Lausanne on 26 November.

#### *2.12.4.5 SUPPORT FROM FIE*

The OFC appreciates the invaluable and generous administrative and technical support it receives from the interim President, the CEO and all the staff at the FIE office.

The OFC acknowledges the important financial support it receives annually from the FIE. The OFC greatly appreciated the additional support received during the Covid crisis.

Unfortunately, with a substantial cut to FIE funding as of 2023, it may be difficult in the future to maintain the same number and quality of OFC development activities.

## **2.12.5 AFRICAN FENCING CONFEDERATION**

### *2.12.5.1 TOURNAMENTS*

- 1.** Organisation of the African Cadet-Juniors Championships: The African Cadet-Juniors Fencing Championships were organised by the Fencing Federation of Nigeria in Lagos (Nigeria) from February 22nd to 27th, 2022.
- 2.** Organisation of the African Seniors Championships: Fencing Federation of Morocco hosted the competitions in Casablanca from June 15th to 19th 2022.
- 3.** Organisation of the FIE World Cups: The Men's Foil World Cup was organised in Egypt from 25th to 27th of February 2022. The Women's Sabre World Cup was organised in Tunisia from 06th to 07th of May 2022.

### *2.12.5.2 PARTICIPATION IN FIE COMPETITIONS:*

African fencers participated in the FIE organised competitions:

- Cadet-Juniors World Championships in Dubai, UAE, from 2nd to 10th of April 2022
- Senior World Championships in Cairo, Egypt, from 15th to 23rd of July 2022
- Various World Cup, Grand Prix, and Satellites

### *2.12.5.3 ACTIVITIES*

- In the period from February to November 2022 the FIE Academy in Johannesburg, South Africa, successfully finalised programme for the 5th Class of students from 5 African Countries (South Africa (2), Kenya (2), Angola, Botswana, Congo)
- The CAE President and Secretary General participated on 25th of September 2022 in Tashkent (Uzbekistan) to the Intercontinental Conference "New Methods and New Vision for Development of fencing World", organised by the Asian Fencing Confederation.



- The CAE Secretary General participated on 22nd of October 2022 in Panama City, Panama, to the Congress of the Pan-American Fencing Confederation.
- Alongside the Seniors African Championship, the CAE Board meeting was organised on 18th of June 2022, at the Complex Sportif Mohamed V in Casablanca.
- Some African countries are founding members of the Alliance Francophone d’Escrime and they were involved in activities of this alliance.
- The CAE Extraordinary Congress was on 25th of November 2022 in Lausanne
- Presidents and representatives of African National Federations participated in the FIE Congress in Lausanne, November 26th 2022.

## 3 SPORTING ACTIVITIES

### 3.1 WINNERS OF OFFICIAL RANKINGS

#### OFFICIAL RANKINGS - SENIORS 2021-2022

WOMEN'S EPEE			
1	CHOI	Injeong	KOR
2	SONG	Sera	KOR
3	KUN	Anna	HUN
4	CANDASSAMY	Marie-Florence	FRA
5	FIAMINGO	Rossella	ITA
6	KONG	Man Wai Vivian	HKG
7	DIFFERT	Nelli	EST
8	SANTUCCIO	Alberta	ITA

MEN'S EPEE			
1	CANNONE	Romain	FRA
2	BOREL	Yannick	FRA
3	LIMARDO GASCON	Ruben	VEN
4	REIZLIN	Igor	UKR
5	KANO	Koki	JPN
6	KOCH	Mate Tamas	HUN
7	BARDENET	Alexandre	FRA
8	KURBANOV	Ruslan	KAZ

WOMEN'S FOIL			
1	KIEFER	Lee	USA
2	VOLPI	Alice	ITA
3	HARVEY	Eleanor	CAN
4	THIBUS	Ysaora	FRA
5	ERRIGO	Arianna	ITA
6	PALUMBO	Francesca	ITA
7	EBERT	Leonie	GER
8	SAUER	Anne	GER

MEN'S FOIL			
1	MARINI	Tommaso	ITA
2	CHEUNG	Ka Long	HKG
3	FOCONI	Alessio	ITA
4	LEFORT	Enzo	FRA
5	GAROZZO	Daniele	ITA
6	ABOUELKASSEM	Alaaeldin	EGY
7	ITKIN	Nick	USA
8	CHOI	Chun Yin Ryan	HKG

WOMEN'S SABRE			
1	BASHTA	Anna	AZE
2	EMURA	Misaki	JPN
3	GEORGIADOU	Despina	GRE
4	GREGORIO	Rossella	ITA
5	QUEROLI	Caroline	FRA
6	GKOUNTOURA	Theodora	GRE
7	APITHY - BRUNET	Manon	FRA
8	MARTIN-PORTUGUES	Lucia	ESP

MEN'S SABRE			
1	SZILAGYI	Aron	HUN
2	BAZADZE	Sandro	GEO
3	OH	Sanguk	KOR
4	CURATOLI	Luca	ITA
5	KIM	Junghwan	KOR
6	APITHY	Bolade	FRA
7	PIANFETTI	Maxime	FRA
8	TEODOSIU	Iulian	ROU

## OFFICIAL RANKINGS - JUNIORS 2021-2022

WOMEN'S EPEE			
1	HUSISIAN	Hadley	USA
2	BEKMURZOVA	Yana	RUS
3	MUHARI	Eszter	HUN
4	KLASIC	Alicja	POL
5	MURZATAEVA	Dilnaz	UZB
6	ERTURK	Aleyna	TUR
7	BUKI	Lili	HUN
8	NAZAROVA	Anastasiia	RUS

MEN'S EPEE			
1	KESZTHELYI	Zsombor	HUN
2	YASSEEN	Mohamed	EGY
3	HEURLIN VAZQUEZ	Lino	FRA
4	VINEIS	Sven	SUI
5	ELSAIED	Mohamed	EGY
6	BROCHARD	Theo	SUI
7	MENCARELLI	Simone	ITA
8	KOVACS	Gergely	HUN

WOMEN'S FOIL			
1	SCRUGGS	Lauren	USA
2	STUTCHBURY	Carolina	GBR
3	TAKEYAMA	Yuzuha	JPN
4	FERRARI	Carlotta	ITA
5	BUDENKO	Kateryna	UKR
6	RHODES	Zander	USA
7	WIECZOREK	Aleksandra	POL
8	SOPIT	Olga	UKR

MEN'S FOIL			
1	EMMER	Chase	USA
2	ANANE	Anas	FRA
3	DI VEROLI	Damiano	ITA
4	IIMURA	Kazuki	JPN
5	SZEMES	Gergo	HUN
6	LOMBARDI	Giulio	ITA
7	LI	Brandon	USA
8	OSIPOV	Dmitrii	RUS

WOMEN'S SABRE			
1	BATTAI	Sugar Katinka	HUN
2	SKARBONKIEWICZ	Magda	USA
3	AIME	Amalia	FRA
4	DAYIBEKOVA	Zaynab	UZB
5	JOHNSON	Honor	USA
6	HERBON	Felice	GER
7	SZUCS	Luca	HUN
8	GIRARDIN	Cyrielle	FRA

MEN'S SABRE			
1	HEATHCOCK	Colin	GER
2	TORRE	Pietro	ITA
3	GARRIGUE	Remi	FRA
4	HEATHCOCK	Antonio	GER
5	NITU	Radu	ROU
6	MOATAZ	Adham	EGY
7	MAMUTOV	Sherzod	UZB
8	CHAN	Lok Hei Royce	HKG

### OFFICIAL RANKINGS – SENIORS TEAMS 2021-2022

	WOMEN'S EPEE	MEN'S EPEE	WOMEN'S FOIL	MEN'S FOIL	WOMEN'S SABRE	MEN'S SABRE
1	KOR	1 FRA	1 ITA	1 ITA	1 FRA	1 KOR
2	ITA	2 ITA	2 USA	2 USA	2 KOR	2 HUN
3	FRA	3 KOR	3 JPN	3 FRA	3 HUN	3 GER
4	POL	4 HUN	4 FRA	4 JPN	4 JPN	4 ITA
5	USA	5 JPN	5 CAN	5 EGY	5 ITA	5 FRA
6	GER	6 UKR	6 POL	6 POL	6 ESP	6 USA
7	SUI	7 SUI	7 GER	7 HKG	7 AZE	7 EGY
8	EST	8 ESP	8 KOR	8 KOR	8 USA	8 IRI

### OFFICIAL RANKINGS – JUNIORS TEAMS 2021-2022

	WOMEN'S EPEE	MEN'S EPEE	WOMEN'S FOIL	MEN'S FOIL	WOMEN'S SABRE	MEN'S SABRE
1	ISR	1 EGY	1 USA	1 ITA	1 FRA	1 EGY
2	POL	2 SUI	2 UKR	2 POL	2 HUN	2 ITA
3	UZB	3 USA	3 ROU	3 FRA	3 USA	3 UZB
4	USA	4 FRA	4 ITA	4 USA	4 ITA	4 ROU
5	RUS	5 UKR	5 POL	5 HUN	5 POL	5 POL
6	SUI	6 EST	6 RUS	6 GER	6 UZB	6 ESP
7	EGY	7 ITA	7 FRA	7 DEN	7 BUL	7 KAZ
8	HUN	8 ESP	8 ISR	8 UZB	8 UKR	8 FRA

### 3.2 WORLD CHAMPIONSHIPS - JUNIORS/CADETS 2022

The World Championships took place in **Dubai (UAE) from 2nd to 10th April 2022.**

The officials and referees appointed by the FIE were as follows:



#### Officials:

Dieter	LAMMER	GER	President of Directoire Technique
Arno	SCHNEIDER	BRA	Chief of Protocol
Andras	SZETEY	HUN	Member of Directoire Technique
Marjorie	GINOUVIER-DUFRENE	FRA	Member of Directoire Technique
Ziad	FERIANI	TUN	Member of Directoire Technique
Martina	ZMAIC	CRO	Member of Directoire Technique
Majed	AL MANSOORI	UAE	Member of Directoire Technique
Ting	HAN	CHN	Member of Directoire Technique
Lisa	HUZEL	CAN	Delegate of Medical Commission
Hazem	ABED	KSA	Delegate of Medical Commission
Davood	SHAFaat	IRI	Delegate of Medical Commission
Jean-Marc	GUENET	FRA	Delegate of Refereeing Commission
Marius	FLOREA	ROU	Delegate of Refereeing Commission
Aida	KHASANOVA	UZB	Delegate of Refereeing Commission
Irina	KNYSCH	RSA	Delegate of Refereeing Commission
Olga	COJOCARI	MDA	Delegate of Refereeing Commission
Salah	FERJANI	TUN	Delegate of Refereeing Commission
Islam Bilel	HADI	ALG	Delegate of SEMI Commission
Baiba	BRANDULE	LAT	Delegate of SEMI Commission

## Referees:

<b>Khadija</b>	ZERABIB	ALG	<b>Anna</b>	KAMYNINA	NZL
<b>Adriana</b>	ATTAR COHEN	ARG	<b>Jaroslav</b>	MOJSKI	POL
<b>Roman</b>	BEREUTER	AUT	<b>Miguel</b>	MACHADO	POR
<b>Fikrat</b>	VALIYEV	AZE	<b>Konstantin</b>	GRITSAEV	PUR
<b>Jeffrey</b>	DELATRE	BEL	<b>Qasim Abdulla</b>	YAHYA	QAT
<b>Ana Clara Franke</b>	RODRIGUES	BRA	<b>Andreea</b>	DOANA	ROU
<b>Vasil</b>	MILENCHEV	BUL	<b>Andrei</b>	KOVRIJNYKH	RSA
<b>Alexey</b>	KUZNETSOV	CAN	<b>Eugene Wee Hong</b>	CHUA	SGP
<b>Carlos</b>	VALENCIA MORA	COL	<b>Ana</b>	KOVRLIJA	SRB
<b>Vilem</b>	MADR	CZE	<b>Ambre</b>	CIVIERO-AIVANO	SUI
<b>Abd Allah</b>	SAMEH	EGY	<b>Tomasz</b>	GORAL	SWE
<b>Vanesa</b>	CHICHON	ESP	<b>Nunta</b>	CHANTASUVANNASIN	THA
<b>David</b>	SAKHVADZE	GEO	<b>Hao Chih</b>	HUANG	TPE
<b>Benjamin</b>	DENZER	GER	<b>Iheb</b>	BEN CHAABENE	TUN
<b>Andreas</b>	DOUVIS	GRE	<b>Abdussamet</b>	ARSLAN	TUR
<b>Gerald</b>	CHENG CHI-HUNG	HKG	<b>Abdullah</b>	AL HAMMADI	UAE
<b>Reza</b>	PEYKARARA	IRI	<b>Khaled</b>	AL MARZOOQI	UAE
<b>Alaa A.</b>	FALAH	IRQ	<b>Khalifa</b>	AL ZAROONI	UAE
<b>Vincenzo</b>	COSTANZO	ITA	<b>Omran</b>	ALBLOOSHI	UAE
<b>Eyyad</b>	MAGHAYREH	JOR	<b>Ali Albaqer</b>	ALHAMMADI	UAE
<b>Ken-Ichi</b>	SASADA	JPN	<b>Sultan</b>	ALMAAZMI	UAE
<b>Yevgeniy</b>	DYAKOKIN	KAZ	<b>Ali</b>	ALMARZOOQI	UAE
<b>Jong Hwan</b>	KO	KOR	<b>Ashwaq</b>	ALMESSABI	UAE
<b>Rashed</b>	ALSHAMALI	KUW	<b>Laura</b>	DECKER	USA
<b>Mihail</b>	PAGHIEV	MDA	<b>Le Ba Quang</b>	NGUYEN	VIE
<b>Juan Carlos</b>	RIOS RIVERA	MEX			

## RESULTS OF INDIVIDUAL EVENTS – CADETS

WOMEN'S EPEE			
1	ERTURK	Aleyna	TUR
2	MAKSYMENKO	Anna	UKR
3	HOMMA	Mizuki	JPN
3	CHEN	Hailin	HKG
5	HU	Grace	CAN
6	GU	Sarah	USA
7	LOZANO	Candela	ESP
8	PATRI	Maja	HUN

MEN'S EPEE			
1	IMREK	Samuel	USA
2	SARID	Alon	ISR
3	MASTROMARINO	Fabio	ITA
3	PERCHUK	Maksym	UKR
5	LIU	Alexander	USA
6	ZHANG	Nicholas	CAN
7	PELLE	Domankos	HUN
8	BROOKE	Alec	GBR

WOMEN'S FOIL			
1	GUO	Jessica Zi Jia	CAN
2	STUTCHBURY	Carolina	GBR
3	NAGASE	Rino	JPN
3	MOLINARI	Matilde	ITA
5	CHEUNG	Kemei	SGP
6	IIMURA	Ayano	JPN
7	KIM	Seungyeon	KOR
8	KURITZKY	Gili	ISR

MEN'S FOIL			
1	CHENG	Tit Nam	HKG
2	LINDNER	Ruben	GER
3	IACOMONI	Matteo	ITA
3	CHEN	Andrew	USA
5	HELMY-COCOYNACQ	Adrien	FRA
6	SPICHIGER	Antoine	FRA
7	SOSNOV	David	GBR
8	DE CRISTOFARO	Mattia	ITA

WOMEN'S SABRE			
1	SKARBONKIEWICZ	Magda	USA
2	SULLIVAN	Siobhan	USA
3	MANGA	Alejandra	FRA
3	KIM	Eunyu	KOR
5	KUVAEVA	Alexandra	GEO
6	SHOKIROVA	Samira	UZB
7	HUSEYNOVA	Zarifa	AZE
8	JANE	Melissa	GBR

MEN'S SABRE			
1	KODIROV	Zuhriddin	UZB
2	HEATHCOCK	Colin	GER
3	JI	Cody	USA
3	MORRILL	William	USA
5	LIANG	Connor	USA
6	PECH	Kornel	HUN
7	POGU	Axel	FRA
8	AYMURATOV	Musa	UZB

## MEDALS TABLE

	Gold	Silver	Bronze	Total
USA	2	1	3	6
HKG	1	0	1	2
UZB	1	0	0	1
TUR	1	0	0	1
CAN	1	0	0	1
GER	0	2	0	2
UKR	0	1	1	2

	Gold	Silver	Bronze	Total
ISR	0	1	0	1
GBR	0	1	0	1
ITA	0	0	3	3
JPN	0	0	2	2
KOR	0	0	1	1
FRA	0	0	1	1

## GRAND PRIX OF NATIONS

The Cadet Grand Prix of Nations was awarded to USA.

### RESULTS OF INDIVIDUAL EVENTS – JUNIORS

WOMEN'S EPEE			
1	HUSISIAN	Hadley	USA
2	FEYGIN	Nicole	ISR
3	KETKAR	Ketki	USA
3	ERTURK	Aleyna	TUR
5	ZGRZYNIAK	Kinga	POL
6	MUHARI	Eszter	HUN
7	BUKI	Lili	HUN
8	KLASIK	Alicja	POL

MEN'S EPEE			
1	KESZTHELYI	Zsombor	HUN
2	YASSEEN	Mohamed	EGY
3	JEAL	James	GBR
3	HEURLIN VAZQUEZ	Lino	FRA
5	SATHASIVAN NIRMALA	Siva Magesh	IND
6	VINEIS	Sven	SUI
7	FRAZAO	Miguel	POR
8	MATSUMOTO	Ryu	JPN

WOMEN'S FOIL			
1	SCRUGGS	Lauren	USA
2	TAKEYAMA	Yuzuha	JPN
3	STUTCHBURY	Carolina	GBR
3	BUDENKO	Kateryna	UKR
5	GUO	Jessica Zi Jia	CAN
6	SOPIT	Olga	UKR
7	WIECZOREK	Aleksandra	POL
8	HONG	Sein	KOR

MEN'S FOIL			
1	IIMURA	Kazuki	JPN
2	AN	Hyeonbhin	KOR
3	ANANE	Anas	FRA
3	EMMER	Chase	USA
5	LI	Brandon	USA
6	DI VEROLI	Damiano	ITA
7	LOUIE	Bryce	USA
8	SOSNOV	David	GBR

WOMEN'S SABRE			
1	SKARBONKIEWICZ	Magda	USA
2	JOHNSON	Honor	USA
3	BATAI	Sugar Katinka	HUN
3	DAYIBEKOVA	Zaynab	UZB
5	ATANASOVA	Kalina	BUL
6	GIRARDIN	Cyrielle	FRA
7	STEFANELLO	Lucia	ITA
8	ERBIL	Nisanur	TUR

MEN'S SABRE			
1	HEATHCOCK	Colin	GER
2	TORRE	Pietro	ITA
3	HWANG	Heegeun	KOR
3	HEATHCOCK	Antonio	GER
5	NITU	Radu	ROU
6	DAN	Wei Zuo	SGP
7	CHAN	Lok Hei Royce	HKG
8	MORAN	Yago	ESP



## RESULTS OF TEAM EVENTS – JUNIORS

Women's epee		Men's epee		Women's foil		Men's foil		Women's sabre		Men's sabre	
1	ISR	1	EGY	1	USA	1	ITA	1	FRA	1	ITA
2	POL	2	USA	2	ITA	2	FRA	2	HUN	2	ROU
3	USA	3	FRA	3	JPN	3	HUN	3	ITA	3	EGY
4	SWE	4	SUI	4	UKR	4	POL	4	MEX	4	ESP
5	ROU	5	UKR	5	CAN	5	USA	5	USA	5	FRA
6	GBR	6	POL	6	CZE	6	KOR	6	TUR	6	HUN
7	UZB	7	HUN	7	POL	7	SVK	7	KOR	7	SGP
8	ESP	8	KAZ	8	ESP	8	UZB	8	SGP	8	UZB

## MEDALS TABLE

	Gold	Silver	Bronze	Total
USA	4	2	3	9
ITA	2	2	1	5
FRA	1	1	3	5
HUN	1	1	2	4
JPN	1	1	1	3
EGY	1	1	1	3
ISR	1	1	0	2
GER	1	0	1	2

	Gold	Silver	Bronze	Total
KOR	0	1	1	2
ROU	0	1	0	1
POL	0	1	0	1
GBR	0	0	2	2
UZB	0	0	1	1
UKR	0	0	1	1
TUR	0	0	1	1

## PARTICIPATION

Number of fencers 1357  
Number of countries 99

## GRAND PRIX OF NATIONS

The Junior Grand Prix of Nations was awarded to USA.

Weapons	Cadets	Juniors	Teams
Women's epee	109	161	33
Men's epee	142	210	42
Women's foil	104	149	32
Men's foil	119	180	37
Women's sabre	92	128	27
Men's sabre	96	154	34

### 3.3 SENIOR WORLD CHAMPIONSHIPS 2022

The World Championships took place from **15th to 23rd July 2022** in Cairo (EGY).  
The **officials** and **referees** appointed by the FIE were as follows:



#### Officials:

Dieter	LAMMER	GER	President of the Directoire Technique
Arno	PERILLIER SCHNEIDER	BRA	Head of Protocol
Ziad	FERIANI	TUN	Member of the Directoire Technique
Marjorie	GINOUVIER-DUFRENE	FRA	Member of the Directoire Technique
Ting	HAN	CHN	Member of the Directoire Technique
Andras	SZETEY	HUN	Member of the Directoire Technique
Jennifer	YAMIN	USA	Member of the Directoire Technique
Salma	MOKABEL	EGY	Member of the Directoire Technique
Jeremy	SUMMERS	USA	Medical Commission Delegate
Maha	MOURAD	EGY	Medical Commission Delegate
Abed	HAZEM	KSA	Medical Commission Delegate
Irina	KNYSCH	RSA	Refereeing Commission Delegate
Amgad	BADAWI	PUR	Refereeing Commission Delegate
Pape Khassoum	TOURE	SEN	Refereeing Commission Delegate
Olga	COJOCARI	MDA	Refereeing Commission Delegate
Changgon	KIM	KOR	Refereeing Commission Delegate
Marius	FLOREA	ROU	Refereeing Commission Delegate
Maria Wilda	EBERL LOPEZ	CHI	SEMI Commission Delegate
Zeyad	SALEEM	IRQ	SEMI Commission Delegate
Islam Bilel	HADI	ALG	SEMI Commission Delegate

### Referees:

Fikrat	Valiyev	AZE
Yevgeniy	Dyaokokin	KAZ
Ken-Ichi	Sasada	JPN
Andreas	Douvis	GRE
Luigi	Martilotti	ITA
Abdussamet	Arslan	TUR
Min	Qiao	CHN
Andreea	Doana	ROU
Adriana	Attar Cohen	ARG
Vanesa	Chichon	ESP
Miklos	Kosa	HUN
Reza	Peykarara	IRI
Vasil	Milenchev	BUL
Laura	Decker	USA
Zaza	Mchedlidze	GEO
Pascal	Mage	FRA
Gaspare	Armata	ITA
Tim	Bardenhagen	GER
Eugene	Chua	SGP
Nunta	Chantasuvannasin	THA
Miguel	Machado	POR
Sangwon	Suh	KOR
Andrzej	Witkowski	POL

Vilem	Madr	CZE
Florin	Gheorghe	ROU
Hao Chih	Huang	TPE
Ayoub	Ferjani	TUN
Katalin	Varga	HUN
Khadidja	Zerabib	ALG
Mads	Herskov	DEN
Ana Clara Franke	Rodrigues	BRA
Aleska	Aular	VEN
Dilorom	Turdikulova	UZB
Adrian	Speakman	GBR
Mihail	Paghiev	MDA
Andrei	Kovrijnykh	RSA
Ambre	Civiero	SUI
Tamim	Ghazy	EGY
Amr	Khaled	EGY
Islam	Emad	EGY
Abdallah	Sameh	EGY
Ahmed	Mamdouh	EGY
Aya	Hashem	EGY
Rabab	Hossama	EGY
Ahmed	Amr Samir	EGY
Mostafa	Elmoataz	EGY

## RESULTS OF INDIVIDUAL EVENTS

WOMEN'S EPEE			
1	SONG	Sera	KOR
2	NDOLO	Alexandra	GER
3	FIAMINGO	Rossella	ITA
3	KONG	Man Wai Vivian	HKG
5	DIFFERT	Nelli	EST
6	NAVARRIA	Mara	ITA
7	ZHU	Mingye	CHN
8	YU	Sihan	CHN

MEN'S EPEE			
1	CANNONE	Romain	FRA
2	MINOBE	Kazuyasu	JPN
3	LOYOLA	Neisser	BEL
3	REIZLIN	Igor	UKR
5	KANO	Koki	JPN
6	KURBANOV	Ruslan	KAZ
7	ALIMZHANOV	Elmir	KAZ
8	FONG	Hoi Sun	HKG

WOMEN'S FOIL			
1	THIBUS	Ysaora	FRA
2	ERRIGO	Arianna	ITA
3	BOLDOR	Maria	ROU
3	KIEFER	Lee	USA
5	UENO	Yuka	JPN
6	PALUMBO	Francesca	ITA
7	AZUMA	Sera	JPN
8	RANVIER	Pauline	FRA

MEN'S FOIL			
1	LEFORT	Enzo	FRA
2	MARINI	Tommaso	ITA
3	CHEUNG	Ka Long	HKG
3	ITKIN	Nick	USA
5	FOCONI	Alessio	ITA
6	ABOUELKASSEM	Alaaeldin	EGY
7	CHOUPENITCH	Alexander	CZE
8	SZEMES	Gergo	HUN

WOMEN'S SABRE			
1	EMURA	Misaki	JPN
2	BASHTA	Anna	AZE
3	GEORGIADOU	Despina	GRE
3	NAVARRO	Araceli	ESP
5	GKOUNTOURA	Theodora	GRE
6	MARTIN-PORTUGUES	Lucia	ESP
7	NOUTCHA	Sarah	FRA
8	EIFLER	Larissa	GER

MEN'S SABRE			
1	SZILAGYI	Aron	HUN
2	PIANFETTI	Maxime	FRA
3	BAZADZE	Sandro	GEO
3	TEODOSIU	Iulian	ROU
5	OH	Sanguk	KOR
6	SAMELE	Luigi	ITA
7	PAKDAMAN	Ali	IRI
8	TORRE	Pietro	ITA

## RESULTS OF TEAM EVENTS

Women's epee		Men's epee		Women's foil		Men's foil		Women's sabre		Men's sabre	
1	KOR	1	FRA	1	ITA	1	ITA	1	HUN	1	KOR
2	ITA	2	ITA	2	USA	2	USA	2	FRA	2	HUN
3	POL	3	JPN	3	FRA	3	FRA	3	JPN	3	ITA
4	FRA	4	HUN	4	JPN	4	JPN	4	ESP	4	GER
5	USA	5	SUI	5	CAN	5	HKG	5	GER	5	FRA
6	SUI	6	CHN	6	ESP	6	KOR	6	AZE	6	EGY
7	HKG	7	KOR	7	POL	7	CAN	7	ITA	7	CHN
8	UKR	8	UKR	8	CHN	8	EGY	8	USA	8	TUR

## MEDALS TABLE

	Gold	Silver	Bronze	Total		Gold	Silver	Bronze	Total
FRA	4	2	2	8	ROU	0	0	2	2
KOR	3	0	0	3	HKG	0	0	2	2
ITA	2	4	2	8	GRE	0	0	1	1
HUN	2	1	0	3	ESP	0	0	1	1
JPN	1	1	2	4	POL	0	0	1	1
USA	0	2	2	4	BEL	0	0	1	1
GER	0	1	0	1	GEO	0	0	1	1
AZE	0	1	0	1	UKR	0	0	1	1

## PARTICIPATION

Number of fencers 895  
Number of countries 104

## GRAND PRIX OF NATIONS

The Senior Nations Grand Prix was awarded to France.

Weapons	Individuals	Teams
Women's epee	158	33
Men's epee	192	44
Women's foil	118	24
Men's foil	156	33
Women's sabre	133	29
Men's sabre	143	32

### 3.4 2022 VETERANS WORLD CHAMPIONSHIPS

The veterans World Championships took place in **Zadar (CRO)** from **6th to 12th October 2022**.

The **officials** and **referees** appointed by the FIE were as follows:

#### Officials:

Ziad	FERIANI	TUN	President of the Directoire Technique
Benoit	PINCEMAILLE	FRA	Member of the Directoire Technique
Filip	VUKOVIC	CRO	Member of the Directoire Technique
Jennifer	YAMIN	USA	Member of the Directoire Technique
Giandomenico	VARALLO	ITA	SEMI Commission Delegate
Sabrina	HALAIMIA	ALG	Medical Commission Delegate
Jameleddine	FERJANI	TUN	Medical Commission Delegate
Salah	FERJANI	TUN	Refereeing Commission Delegate
Velichka	HRISTEVA	BUL	Representative of the Executive Committee in the Veterans Council

#### Referees:

Iheb	BEN CHAABENE	TUN	Jaroslaw	MOJSKI	POL
Tamim	GHAZY	EGY	Tomasz	GORAL	SWE
Adriana	ATTAR COHEN	ARG	Pavol	CELLER	SVK
Jacobo	MORALES	MEX	Dora	DELI	HUN
Kelly	KOEHLER	USA	Mihail	PAGHIEV	MDA
Konstantin	GRITSAEV	PUR	Irina	PEIKRISHVILI	GEO
Margarita	ANDREEVA	UZB	Florence	DUCARME	FRA
Hwa Jung	DOO	KOR	Tin	VRBANC	CRO
Junsangsee	WONGSAKUN	THA	Zoran	BUNTJELIC	CRO
Yevgeniy	DYAKOKIN	KAZ	Ante	POLJAK	CRO
Tomoko	HIROSE	JPN	Vasil	MILENCHEV	BUL
Vincenzo	COSTANZO	ITA	Reka	BALOGH	ROU
Roman	BEREUTER	AUT	Denis	OSTROVSKI	EST
Vanesa	CHICHON	ESP	Milijan	KOVACEVIC	SRB
Ilgin	GUCLUER	TUR	Efstathios	GEROSIDERIS	GRE
Mads	HEJRSKOV	DEN			

## RESULTS OF INDIVIDUAL EVENTS

WOMEN'S EPEE 50 +			
1	ALBERTSON	Pia	SWE
2	MILANOLI	Luisa	ITA
3	USHER	Georgina	GBR
3	GYIURKAN	Judit	HUN
5	NUTT	Abigail	AUS
6	STIHL	Judith	GER
7	PREAUX	Valerie	FRA
8	TANZMEISTER	Dorothea	AUT

MEN'S EPEE 50 +			
1	ATANASSOW	Aleksander	POL
2	PRADON	Emmanuel	FRA
3	RUMETSCH	Hannes	GER
3	CALAMBE	Thierry	FRA
5	SERGUN	Eduard	FIN
6	PEYRET LACOMBE	Emmanuel	FRA
7	WENDT	Carl-Henrik	SWE
8	PIRANI	Claudio	ITA

WOMEN'S FOIL 50 +			
1	GANASSIN	Martina	ITA
2	KOLLMETZ	Hilke	GER
3	REESE	Stefanie	GER
3	PREAUX	Valerie	FRA
5	GOMAERE	Mariele	FRA
6	ROUSSELOT	Bella	FRA
7	BENUCCI	Elena	ITA
8	SHAHINYAN	Anahit	ARM

MEN'S FOIL 50 +			
1	DI RUSSO	Fabio	ITA
2	LACROIX	Cyril	FRA
3	SUAREZ C.	Rafael A.	USA
3	PETERS	Peer-Uwe	GER
5	TYSHCHENKO	Andrey	AUS
6	TROBOE	Bruno	FRA
7	ABIDOGUN	Kola	GBR
8	RAEKER	Hans Martin	GER

WOMEN'S SABRE 50 +			
1	SEAL	Julie	USA
2	DAVIDSON	Beth	GBR
3	KOLLMETZ	Hilke	GER
3	TANZMEISTER	Dorothea	AUT
5	DRIGO	Costanza	ITA
6	MARTIN	Caroline	GBR
7	GRAUDINS	Gunilla	GER
8	LEVEQUE	Isabelle	FRA

MEN'S SABRE 50 +			
1	ESQUERRE	Olivier	FRA
2	MARGETICH	Gerhard	AUT
3	BERGER	Sven	GER
3	QUENTIN	Frédéric	FRA
5	THORNTON	Ronald	USA
6	NICASTRO	Carlo	ITA
7	PRUDOVSKI	Dimitri	GER
8	MIRONOVAS	Michailas	LTU

## RESULTS OF INDIVIDUAL EVENTS

WOMEN'S EPEE 60 +			
1	HOHLBEIN	Frauke	GER
2	HEINAMAA	Anna	FIN
3	REGUIGNE	Patricia	FRA
3	KIRCHEIS	Astrid	GER
5	HUTCHISON	Jane S	GBR
6	ASHER	Valerie	USA
7	GORDET	Christina	USA
8	RUNOLD	Jeannette	SWE

MEN'S EPEE 60 +			
1	SOKOLOV	Volodymyr	UKR
2	BELLMANN	Achim	GER
3	LE BARBIER	Herve	FRA
3	KERNOHAN	Hugh Deans	GBR
5	CONY	Philippe	FRA
6	JINDRA	Jan	CZE
7	ZUIKOV	Viktor	EST
8	KRZEMINSKI	Mariusz	POL

WOMEN'S FOIL 60 +			
1	WALTERS	Anne-Marie	USA
2	STARKE-FAULKNER	Jenette	USA
3	ANDERSON	Sheila	GBR
3	BONNEY-MILLETT	Jenny	AUS
5	WORMAN	Gillian	GBR
6	CIRILLO	Gianna	ITA
7	FELLEGI	Ildiko	HUN
8	SZEREDAY	Judith Marta	ROU

MEN'S FOIL 60 +			
1	HUERTO	Stephane	FRA
2	JOLYOT	Pascal	FRA
3	TROIANO	John	GBR
3	MIRALDI	Fabio	ITA
5	CSAK	Attila	HUN
6	BOSIO	Marco	ITA
7	EPPLY-SCHMIDT	Paul	USA
8	RIJSENBRIJ	Hans	NED

WOMEN'S SABRE 60 +			
1	DU	Min Yi	AUS
2	HUTCHISON	Jane S	GBR
3	CERBONI BOUSQUET	Anne	FRA
3	RUNYAN	Heidi	USA
5	EYRE	Jane	USA
6	ZINI	Sylvie	FRA
7	JERKINS	Jayne	USA
8	BANDIERI	Claudia	ITA

MEN'S SABRE 60 +			
1	LUNDBORG	Mark	USA
2	FEIRA CHIOS	Alberto	ITA
3	TAKACSY	Laszlo	HUN
3	RUNYAN	Joshua	USA
5	TAILLANDIER	Jean Francois	FRA
6	PIMENAU	Aleh	NED
7	LUZZO	Antonio	ITA
8	KOPYLOV	Dmitri	USA



## RESULTS OF INDIVIDUAL EVENTS

### WOMEN'S EPEE 70 +

1	KOCAB	Elizabeth	USA
2	SOMEROJA	Marja-Liisa Tuulikki	FIN
3	DEMAILLE	Marie Chantal	FRA
3	UFF	Susan	GBR
5	BARON	Janet	GBR
6	MARTIN	Annick	FRA
7	GARDINI	Iris	ITA
8	HALDANE	Fiona	GBR

### MEN'S EPEE 70 +

1	GOOSSENS	Bruno	USA
2	MANDRIOLI	Dino	ITA
3	TAYLOR	Daryl	USA
3	MOREAU	John	USA
5	GAUDRY	Francois	FRA
6	DAMAS	Fernando	ESP
7	MARINO	Giuseppe	ITA
8	BOTHELIO	Jere	USA

### WOMEN'S FOIL 70 +

1	SOMEROJA	Marja-Liisa Tuulikki	FIN
2	DEMAILLE	Marie Chantal	FRA
3	GARDINI	Iris	ITA
3	UFF	Susan	GBR
5	STEVENS	Joanne	USA
6	MYERS	Margaret	GBR
7	SCHRAMM	Angelika	GER
8	OFFERLE	Judith	USA

### MEN'S FOIL 70 +

1	PRECHTL	Hanns	GER
2	MCCARTHY	Daniel	USA
3	HINOSHITA	Kenichi	JPN
3	PURDIE	Richard	AUS
5	STREB	Joseph	USA
6	PATTERSON	Jan	USA
7	SCHAUM	Berthold	GER
8	NIZARD	Jean Claude	FRA

### WOMEN'S SABRE 70 +

1	TURNER	Delia	USA
2	DUNN	Linda	USA
3	GARDINI	Iris	ITA
3	GARZINI	Marinella	ITA
5	BROWN	Silvia	GBR
6	FRITH	Vivien Ena	GBR
7	OFFERLE	Judith	USA
8	LEPELTIER	Marie-Josophe	FRA

### MEN'S SABRE 70 +

1	PAROLI	Giulio	ITA
2	STREB	Joseph	USA
3	BOCCONI	Andrea	ITA
3	FILIPPI	Fabrizio	ITA
5	SEUSS	David	USA
6	HELFRICHT	Helmut	GER
7	YUNG	Wang Yip	HKG
8	BAKER	Keith	USA

## RESULTS OF TEAM EVENTS

Women's epee		Men's epee		Women's foil		Men's foil		Women's sabre		Men's sabre	
1	USA	1	ITA	1	ITA	1	FRA	1	ITA	1	ITA
2	GBR	2	GBR	2	USA	2	HUN	2	GBR	2	USA
3	ITA	3	GER	3	FRA	3	GBR	3	USA	3	GER
4	GER	4	SWE	4	GBR	4	GER	4	FRA	4	POL
5	FRA	5	USA	5	GER	5	ITA	5	AUS	5	HUN
6	FIN	6	POL	6	AUS	6	AUS	6	GER	6	FRA
7	SWE	7	CAN	7	FIN	7	USA			7	GBR
8	AUS	8	JPN	8	HUN	8	JPN			8	CAN

## MEDALS TABLE

	Gold	Silver	Bronze	Total
USA	7	6	6	19
ITA	7	3	7	17
FRA	3	4	8	15
GER	2	2	8	12
FIN	1	2	0	3
AUS	1	0	2	3
POL	1	0	0	1

	Gold	Silver	Bronze	Total
UKR	1	0	0	1
SWE	1	0	0	1
GBR	0	5	7	12
HUN	0	1	2	3
AUT	0	1	1	2
JPN	0	0	1	1

## PARTICIPATION

Number of fencers 722  
Number of countries 47

## GRAND PRIX OF NATIONS

The Veterans Grand Prix des Nations was awarded to USA.

EF 50+	63
FF 50+	46
SF 50+	39
EM 50+	92
FM 50+	59
SM 50+	62

EF 60+	45
FF 60+	31
SF 60+	29
EM 60+	89
FM 60+	54
SM 60+	50

EF 70+	26
FF 70+	21
SF 70+	19
EM 70+	56
FM 70+	40
SM 70+	28

## 3.5 CONTINENTAL CHAMPIONSHIPS

### 3.5.1 EUROPE

#### 3.5.1.1 2022 EUROPEAN JUNIOR CHAMPIONSHIPS

These championships were held in **Novi Sad (SRB) from 26th February to 2nd March 2022.**

The **officials** and **referees** who officiated were as follows:

#### Officials:

Dieter	LAMMER	GER	President of Directoire technique
Sanjin	KOVACIC	CRO	Member of Directoire technique
Marjorie	GINOUVIER DUFRÈNE	FRA	Member of Directoire technique
Julius	KRALIK	SVK	Sport Director - DT
Olga	COJOCARI	MDA	FIE Referees Commission delegate
Martina	GANASSIN	ITA	EFC Referees Commission delegate
Vilem	MADR	CZE	EFC Referees Commission delegate
Vasil	MILENCHEV	BUL	EFC Referees Commission delegate
Peter	HUGGINS	GBR	EFC SEMI Commission delegate
Piet	WAUTERS	BEL	EFC SEMI Commission delegate
Dejan	ALEXANDRIC	SRB	EFC Medical Commission delegate
Alessandro	PAGLIACCIA	ITA	EFC Medical Commission delegate
Nikolay	MATEEV	ISL	Safeguarding Officer

#### Referees:

Thibault	OOSTERBOSCH	BEL
Julian	STOYCHEV	BUL
Bojan	MIJATOVIC	CRO
Jan	SRNA	CZE
Mads Vetli	HEJRSKOV	DEN
Ignacio	CASARES	ESP
Denis	OSTROVSKI	EST
Christophe	LIMBARDET	FRA
Christopher	LENNON	GBR
Tatia	APTSIAURI	GEO
Christian	GASPER	GER
Efstathios	GEROSSIDERIS	GRE
Katalin	VARGA	HUN
Sarah	STEACY	IRL
Marco	DAL POZZOLO	ITA
Mindaugas	PALCINSKAS	LTU
András	BORSODI	NOR

Rashed	ALSHAMALI	KUW
Yeraly	TILENSHIYEV	KAZ
Jackobo	MORALES	MEX
Eugene Wee Hong	CHUA	SGP
Laura	DECKER	USA
Min	QIAO	CHN
Marek	GNIEWKOWSKI	POL
Andreea	DOANA	ROU
Maxim	ROGUSHKIN	RUS
Léon	AMEZ-DROZ	SUI
Pavol	CELLER	SVK
Tomasz	GORAL	SWE
Dimitar	PRUGINIC	FIN
Cem	ORAY	TUR
Jure	JEZA	SLO
Miljan	KOVAČEVIĆ	SRB

## RESULTS OF INDIVIDUAL EVENTS

WOMEN'S EPEE			
1	RUSTAMOVA	Anastasiia	RUS
2	MUHARI Eszter	Eszter	HUN
3	KOZIELSKI	Katharina	GER
3	GACHALYI	Greta	HUN
5	NAZAROVA	Anastasiia	RUS
6	CARON	Julia	GBR
7	SILETTI	Vittoria	ITA
8	GOLDMANN	Lara	GER

MEN'S EPEE			
1	KESZTHELYI	Zsombor	HUN
2	BROOKE	Alec	GBR
3	COHEN	Yonatan	ISR
3	GALASSI	Matteo	ITA
5	PIATTI	Enrico	ITA
6	GUROV	Kirill	RUS
7	MAURY	Julien	FRA
8	SALM	Markus	EST

WOMEN'S FOIL			
1	STUTCHBURY	Carolina	GBR
2	BERTINI	Irene	ITA
3	VASILE	Karina	ROU
3	DRUCK	Lior	ISR
5	FERRARI	Carlotta	ITA
6	BONNY	Esther	FRA
7	ROUSSEAU	Marion	FRA
8	BLAZIC	Dorja	CRO

MEN'S FOIL			
1	LOMBARDI	Giulio	ITA
2	CASTANIE	Valérian	FRA
3	DE BELVAL	Paul Antoine	FRA
3	CHAGNON	Eliot	FRA
5	MIHALYI	Andor Istvan	HUN
6	BONATO	Jacopo	ITA
7	KAPPUS	Bastian	GER
8	KARLSEN	Jonas Benjamin	DEN

WOMEN'S SABRE			
1	AIME	Amalia	FRA
2	ERBIL	Nisanur	TUR
3	BATTAI	Sugar Katinka	HUN
3	HERBON	Felice	GER
5	KOROLEVA	Alina	RUS
6	PLEKHANOVA	Vlada	RUS
7	VIALE	Mariella	ITA
8	SKONIECZNA	Daria	POL

MEN'S SABRE			
1	HEATHCOCK	Colin	GER
2	NITU	Radu	ROU
3	GARRIGUE	Remi	FRA
3	HRYCIUK	Szymon	POL
5	ASLAN	Tolga	TUR
6	CIDU	Casian	ROU
7	NASONOV	Dmitriy	RUS
8	HEATHCOCK	Antonio	GER

## RESULTS OF TEAM EVENTS

	Women's epee	Men's epee	Women's foil	Men's foil	Women's sabre	Men's sabre
1	HUN	1 SUI	1 ROU	1 ITA	1 HUN	1 GER
2	GER	2 GBR	2 FRA	2 POL	2 FRA	2 ITA
3	CZE	3 ITA	3 UKR	3 FRA	3 ITA	3 BUL
4	RUS	4 FRA	4 RUS	4 BEL	4 TUR	4 ESP
5	POL	5 HUN	5 CZE	5 HUN	5 POL	5 GEO
6	SUI	6 ISR	6 GER	6 GER	6 ROU	6 FRA
7	EST	7 ESP	7 ITA	7 DEN	7 GER	7 POL
8	ITA	8 EST	8 ESP	8 ESP	8 BUL	8 SRB

## MEDALS TABLE

	Gold	Silver	Bronze	Total
HUN	3	1	2	6
ITA	2	2	3	7
GER	2	1	2	5
FRA	1	3	4	8
GBR	1	2	0	3
ROU	1	1	1	3
SUI	1	0	0	1

	Gold	Silver	Bronze	Total
RUS	1	0	0	1
POL	0	1	1	2
TUR	0	1	0	1
ISR	0	0	2	2
CZE	0	0	1	1
UKR	0	0	1	1
BUL	0	0	1	1

## PARTICIPATION

Number of fencers 509

Number of countries 37

Weapons	Individuals	Teams
Women's epee	92	20
Men's epee	112	22
Women's foil	83	17
Men's foil	89	17
Women's sabre	61	13
Men's sabre	72	16

### 3.5.1.2 2022 EUROPEAN SENIOR CHAMPIONSHIPS

These championships were held in **Antalya (TÜR)** from **17th to 22nd June 2022**.

The **officials** and **referees** who officiated were as follows:

#### Officials:

Jacek	SLUPSKI	POL	Secretary General
Julius	KRALIK	SVK	Sport Director - DT
Dieter	LAMMER	GER	President of Directoire technique
Jonathan	WILLIS	GBR	Member of Directoire technique
Sanjin	KOVACIC	CRO	Member of Directoire technique
Salah	FERJANI	TUN	FIE Referees Commission delegate
Vasil	MILENCHEV	BUL	EFC Referees Commission delegate
Martina	ZMAIC	CRO	EFC SEMI Commission delegate
Sebastien	ROBINEAUX	FRA	EFC Medical Commission delegate
Ana	VALERO - COLLANTES	SWE	Media Manager
Nikolay	MATEEV	ISL	Safeguarding Officer

#### Referees:

Fikrat	VALIYEV	AZE	Jaroslav	MOJSKI	POL
Roman	BEREUTER	AUT	Miguel	MACHADO	POR
Jeffrey	DELATRE	BEL	Ana	KOVRLIJA	SRB
Lazarina	PETKOVA	BUL	Murtaza Berkan	ANIL	TUR
Mirna	BOROSAK	CRO	Ambre	CIVIERO-AIVANO	SUI
Mads	HAJRSKOV	DEN	Tomasz	GORAL	SWE
Vilem	MADR	CZE	Pavol	CELLER	SVK
Pablo	ACEVEDO	ESP	Yevgeniy	DYAOKOKIN	KAZ
Stanislav	MUTSENIK	EST	Mohamed Ayoub	FERJANI	TUN
Pascal	MAGE	FRA	Reza	PEYKARARA	IRI
Adrian	SPEAKMAN	GBR	Ilgin	GÜÇLÜER SÜREKCIGIL	TUR
Zaza	MCHEDLIDZE	GEO	Cem	ORAY	TUR
Alex	SCHIFFERS	GER	Abdussamet	ARSLAN	TUR
Andreas	DOUVIS	GRE	Tansu	TANAÇAN	TUR
Miklos	KOSA	HUN	Ayşe Begümhan	BILGIN ŞEKER	TUR
Jacopo	RUBINI	ITA	Murat	ERDEN	TUR
Mihail	PAGHIEV	MDA	Fatih	GÜNEŞ	TUR
András	BORSODI	NOR			

## RESULTS OF INDIVIDUAL EVENTS

WOMEN'S EPEE			
1	KHARKOVA	Vlada	UKR
2	FIAMINGO	Rossella	ITA
3	SWATOWSKA-WENGLARCZYK	Martyna	POL
3	NAVARRIA	Mara	ITA
5	MUHARI	Eszter	HUN
6	NDOLO	Alexandra	GER
7	KIRPU	Erika	EST
8	BRUNNER	Pauline	SUI

MEN'S EPEE			
1	BOREL	Yannick	FRA
2	TULEN	Tristan	NED
3	BAYAR	Alexis	SUI
3	HEINZER	Max	SUI
5	JURKA	Jakub	CZE
6	LOYOLA	Neisser	BEL
7	SCHMIDT	Richard	GER
8	BRINKMANN	Marco	GER

WOMEN'S FOIL			
1	EBERT	Leonie	GER
2	ERRIGO	Arianna	ITA
3	THIBUS	Ysaora	FRA
3	VOLPI	Alice	ITA
5	SAUER	Anne	GER
6	STUTCHBURY	Carolina	GBR
7	PALUMBO	Francesca	ITA
8	KONDRICZ	Kata	HUN

MEN'S FOIL			
1	GAROZZO	Daniele	ITA
2	MARINI	Tommaso	ITA
3	CHASTANET	Maximilien	FRA
3	AVOLA	Giorgio	ITA
5	CHOUPENITCH	Alexander	CZE
6	SIDO	Alexandre	FRA
7	LLAVADOR	Carlos	ESP
8	FOCONI	Alessio	ITA

WOMEN'S SABRE			
1	BASHTA	Anna	AZE
2	GREGORIO	Rossella	ITA
3	BALZER	Sara	FRA
3	CIESLAR	Zuzanna	POL
5	KHARLAN	Olga	UKR
6	QUEROLI	Caroline	FRA
7	EIFLER	Larissa	GER
8	NAVARRO	Araceli	ESP

MEN'S SABRE			
1	BAZADZE	Sandro	GEO
2	CURATOLI	Luca	ITA
3	APITHY	Bolade	FRA
3	BIBI	Eliott	FRA
5	URSACHI	Razvan	ROU
6	TEODOSIU	Iulian	ROU
7	BAZADZE	Beka	GEO
8	GEMESI	Csanad	HUN

## RESULTS OF TEAM EVENTS

Women's epee		Men's epee		Women's foil		Men's foil		Women's sabre		Men's sabre	
1	FRA	1	ITA	1	ITA	1	ITA	1	FRA	1	HUN
2	ITA	2	ISR	2	FRA	2	FRA	2	ITA	2	UKR
3	UKR	3	FRA	3	GER	3	POL	3	UKR	3	TUR
4	SUI	4	DEN	4	POL	4	ESP	4	HUN	4	FRA
5	HUN	5	SUI	5	ESP	5	UKR	5	ESP	5	ROU
6	SWE	6	UKR	6	UKR	6	GER	6	GRE	6	GER
7	POL	7	HUN	7	HUN	7	GBR	7	GER	7	ITA
8	GER	8	POL	8	ROU	8	BEL	8	TUR	8	POL

## MEDALS TABLE

	Gold	Silver	Bronze	Total
ITA	4	7	3	14
FRA	3	2	6	11
UKR	1	1	2	4
GER	1	0	1	2
AZE	1	0	0	1
GEO	1	0	0	1
HUN	1	0	0	1

	Gold	Silver	Bronze	Total
ISR	0	1	0	1
NED	0	1	0	1
POL	0	0	3	3
SUI	0	0	2	2
TUR	0	0	1	1

## PARTICIPATION

Number of fencers 431

Number of countries 36

Weapons	Individuals	Teams
Women's epee	86	19
Men's epee	102	21
Women's foil	59	11
Men's foil	70	15
Women's sabre	61	13
Men's sabre	55	12



### 3.5.2 ASIA – OCEANIA

#### 3.5.2.1. 2022 ASIAN JUNIOR CHAMPIONSHIPS

These championships were held in **Tashkent (UZB) from 28th February to 3rd March 2022.**

The **officials** and **referees** who officiated were as follows:

#### Officials:

Abbas	FARYABI	IRI	Member of the Directoire Technique
Aida	KHASANOVA	UZB	Member of the Directoire Technique

#### Referees:

Peter	CREESE	AUS
Fikrat	VALIYEV	AZE
Alexey	KUZNETSOV	CAN
Lohith	NAVENDRAN	IND
Mohammad Hassan	GHAHVEHCHIAN	IRI
Ali	SHEHADEH	JOR
Yevgeniy	DYAKOKIN	KAZ
Hassen Matok	ALQUARISHI	KSA
Mihail	PAGHIEV	MDA
Qasim Abdulla	YAHYA	QAT
Natalia	ZHURAVLEVA	RUS
Oleg	KHORVAT	SGP

Nunta	CHANTASUVANNASIN	THA
Abdussamet	ARSLAN	TUR
Khalifa	AL ZAROONI	UAE
Roman	ALEKSANDROV	UZB
Margarita	ANDREEVA	UZB
Ortik	BURIEV	UZB
Rustam	IBRAGIMOV	UZB
Igor	KNYAZEV	UZB
Dilorom	TURDIKULOVA	UZB

## RESULTS OF INDIVIDUAL EVENTS

WOMEN'S EPEE			
1	MURZATAEVA	Dilnaz	UZB
2	CHEN	Hailin	HKG
3	RAKHIMOVA	Sevara	UZB
3	EGAMBERDIEVA	Shakhzoda	UZB
5	TAMBOVTSEVA	Alexandra	KAZ
6	KHATRI	Taniksha	IND
7	TIMASHEVSKAYA	Xeniya	KAZ
8	ZINYAKOVA	Natalya	KAZ

MEN'S EPEE			
1	ALTAWEEL	Hussain	KSA
2	FEDOTOV	Alexandr	KAZ
3	ODEH	Iyad	JOR
3	AL MAAZMI	Mohamed	UAE
5	TIMUROV	Meyirkhan	UZB
6	ALAKKAS	Omar	KSA
7	ISLOMOV	Sarvar	UZB
8	SHUBHAM	Shubham	IND

WOMEN'S FOIL			
1	LEUNG	Ya Lei Janelle	HKG
2	CHUNG	Wan Yin	HKG
3	CHAN	Nok Sze Daphne	HKG
3	DAVRONOVA	Maftunabonu	UZB
5	USMONOVA	Marjona	UZB
6	MAJALI	Roaa	JOR
7	KHOSHKHAHI	Hanieh	IRI
8	GNOYEVA	Alyona	KAZ

MEN'S FOIL			
1	LEUNG	Chin Yu	HKG
2	CHOY	Lucas Brendan	HKG
3	MOLINA	Ilyas	UZB
3	CHENG	Tit Nam	HKG
5	ASRANOV	Mukhammad Yusuf	UZB
6	YUEN	Chi Shun Michael	HKG
7	NURUMOV	Galim	KAZ
8	MIRZAOLIMOV	Muslimbek	UZB

WOMEN'S SABRE			
1	PERDIBAEVA	Gulistan	UZB
2	VASILEVA	Veronika	AUS
3	DAYIBEKOVA	Zaynab	UZB
3	ISROILOVA	Venera	UZB
5	LEUNG	Lok Man Laren	HKG
6	KAPYDZHY	Zhasmin	KAZ
7	PHOKAEW	Tonkhaw	THA
8	SERIKBAY	Adema	KAZ

MEN'S SABRE			
1	MAMUTOV	Sherzod	UZB
2	CHAN	Lok Hei Royce	HKG
3	TAHLA	Abdallah	JOR
3	DUSHAMBOEV	Jaloliddin	UZB
5	SHINDE	Abhay Krishna	IND
6	ALBAHRANI	Ali	KSA
7	SHOKOUHI	Erfan	IRI
8	RASULOV	Bobirjon	UZB

## RESULTS OF TEAM EVENTS

Women's epee		Men's epee		Women's foil		Men's foil		Women's sabre		Men's sabre	
1	UZB	1	HKG	1	HKG	1	HKG	1	KAZ	1	UZB
2	IND	2	UZB	2	KAZ	2	UZB	2	UZB	2	KAZ
3	KAZ	3	KAZ	3	UAE	3	IND	3	HKG	3	HKG
4	KGZ	4	IRI	4	IND	4	KAZ	4	IND	4	KSA
5	HKG	5	IND	5	UZB	5	MAS	5	JOR	5	IRI
6	UAE	6	KSA	6	JOR	6	KUW			6	IND
7	JOR	7	KUW			7	JOR			7	JOR
8	KSA	8	UAE			8	UAE			8	KUW

## MEDALS TABLE

	Gold	Silver	Bronze	Total		Gold	Silver	Bronze	Total
UZB	5	3	7	15	IND	0	1	1	2
HKG	5	4	4	13	AUS	0	1	0	1
KAZ	1	3	2	6	JOR	0	0	2	2
KSA	1	0	0	1	UAE	0	0	2	2

## PARTICIPATION

Number of junior fencers	213
Number of countries	21

Weapons	Individuals	Teams
Women's epee	38	9
Men's epee	49	13
Women's foil	27	6
Men's foil	40	9
Women's sabre	25	5
Men's sabre	34	9

### 3.5.2.2. 2022 ASIAN SENIOR CHAMPIONSHIPS

These championships were held in **Seoul (KOR)** from **10th to 15th June 2022**.

The **officials** and **referees** appointed were as follows:

#### Officials:

Abbas	FARYABI	IRI	President of the Directoire Technique
Tsui Man	VINCENT	HKG	Member of the Directoire Technique
Choi	MYUNG JIN	KOR	Member of the Directoire Technique
Irina	KNYSCH	RSA	FIE Refereeing Commission Delegate
Eyyad	MAGHAYREH	JOR	Delegate of the FCA Refereeing Commission
Suminori	OKMOTO	JPN	Delegate of the SEMI Commission
Davood Reza	SHAFAT	IRI	Delegate of the FIE Medical Commission

#### Referees:

Tamim	GHAZY	EGY
Andreas	DOUVIS	GRE
Gerald	CHENG CHI-HUNG	HKG
Katalin	VARGA	HUN
Edi	SUWARTO	INA
Mojtaba	SARSHOGH	IRI
Tomoko	HIROSE	JPN
Yevgeniy	DYAKOKIN	KAZ
Hwa Jung	DOO	KOR
Soon Young	HONG	KOR
Jin Man	JUNG	KOR
Doo Hong	KIM	KOR
Hyoungryul	KIM	KOR
Jong Hwan	KO	KOR
Jungjae	LEE	KOR

Sangwon	SUH	KOR
Seung Hwan	YANG	KOR
Adnan Abdulhai H	AL SALMI	KSA
Rashed	ALSHAMALI	KUW
Nicola	SHACKLETON	NZL
Richard	FUENZALIDA	PHI
Qasim Abdulla	YAHYA	QAT
Andrei	KOVRIJNYKH	RSA
Eugene Wee Hong	CHUA	SGP
Wongsakun	JUNSANGSEE	THA
Majed	AL MANSOORI	UAE
Margarita	ANDREEVA	UZB
Anh Tuan	PHAM	VIE

## RESULTS OF INDIVIDUAL EVENTS

WOMEN'S EPEE			
1	KONG	Man Wai Vivian	HKG
2	CHOI	Injeong	KOR
3	CHAN	Wai Ling	HKG
3	SATO	Nozomi	JPN
5	SONG	Sera	KOR
6	KANG	Young Mi	KOR
7	YOSHIMURA	Miho	JPN
8	NIKOLAICHUK	Sofiya	KAZ

MEN'S EPEE			
1	KANO	Koki	JPN
2	KOMATA	Akira	JPN
3	PARK	Sangyoung	KOR
3	LAN	Minghao	CHN
5	ALIMZHANOV	Elmir	KAZ
6	KIM	Myeongki	KOR
7	ALEKSANDROV	Roman	UZB
8	SHARLAIMOV	Vadim	KAZ

WOMEN'S FOIL			
1	SHI	Yue	CHN
2	CHEN	Qingyuan	CHN
3	AZUMA	Sera	JPN
3	UENO	Yuka	JPN
5	BERTHIER	Amita	SGP
6	TAKEYAMA	Yuzuha	JPN
7	CHENG	Hui Wai Valerie	HKG
8	CAI	Yuanting	CHN

MEN'S FOIL			
1	CHEUNG	Ka Long	HKG
2	MO	Ziwei	CHN
3	WU	Bin	CHN
3	CHOI	Chun Yin Ryan	HKG
5	SHIKINE	Takahiro	JPN
6	ROBSON	Samuel Elijah	SGP
7	XU	Jie	CHN
8	MATSUYAMA	Kyosuke	JPN

WOMEN'S SABRE			
1	CHOI	Sooyeon	KOR
2	EMURA	Misaki	JPN
3	YANG	Hengyu	CHN
3	FU	Ying	CHN
5	YOON	Jisu	KOR
6	OZAKI	Seri	JPN
7	LIN	Kesi	CHN
8	CHU	Wing Kiu	HKG

MEN'S SABRE			
1	GU	Bongil	KOR
2	KIM	Junghwan	KOR
3	SARKISSYAN	Artyom	KAZ
3	OH	Sanguk	KOR
5	FOTOUHI	Mohammad	IRI
6	STREETS	Kaito	JPN
7	KOKUBO	Mao	JPN
8	ZAHEDI	Nima	IRI

## RESULTS OF TEAM EVENTS

Women's epee		Men's epee		Women's foil		Men's foil		Women's sabre		Men's sabre	
1	KOR	1	KOR	1	JPN	1	JPN	1	KOR	1	KOR
2	HKG	2	UZB	2	CHN	2	KOR	2	JPN	2	JPN
3	JPN	3	JPN	3	KOR	3	HKG	3	CHN	3	IRI
4	CHN	4	CHN	4	SGP	4	TPE	4	KAZ	4	HKG
5	SGP	5	KAZ	5	HKG	5	CHN	5	IND	5	CHN
6	THA	6	HKG	6	AUS	6	SGP	6	SGP	6	KAZ
7	TPE	7	KGZ	7	PHI	7	AUS	7	HKG	7	KUW
8	IND	8	AUS	8	TPE	8	KUW	8	THA	8	THA

## MEDALS TABLE

	Gold	Silver	Bronze	Total
KOR	6	3	3	12
JPN	3	4	5	12
HKG	2	1	3	6
CHN	1	3	5	9

	Gold	Silver	Bronze	Total
UZB	0	1	0	1
KAZ	0	0	1	1
IRI	0	0	1	1

## PARTICIPATION

Number of fencers 298

Number of countries 25

Weapons	Individuals	Teams
Women's epee	44	11
Men's epee	65	17
Women's foil	42	10
Men's foil	50	12
Women's sabre	39	9
Men's sabre	58	14

### 3.5.3 AMERICA

#### 3.5.3.1. 2022 PAN AMERICAN JUNIOR CHAMPIONSHIPS

These championships were held in **Lima (PER) from 21st to 27th March 2022.**

The **officials** and **referees** officiated were as follows:

#### Officials:

Jose Gregorio	BENAVIDES	VEN	President of the Directoire Technique
Melissa	ALVARENGA	ESA	Member of the Directoire Technique
Luis	CRUZ	CRC	Member of the Directoire Technique
Luis	FILARDI	URU	Member of the Directoire Technique
Renan	MATTOS	PER	Member of the Directoire Technique
Amgad	BADAWI	PUR	FIE Refereeing Commission Delegate
Maria Wilda	LOPEZ EBERL	CHI	FIE SEMI Commission Delegate
Catalina	BLANCO	COL	Medical Delegate
Pablo	PÉRES	COL	Medical Delegate

#### Referees:

Pilar	ARENAS	COL	Martin Ezequiel	LORA GRUNWALDT	ARG
Adam	BREWER	USA	Marcos	MORAN	ESA
Karen	CARDENAS	PER	Alejandra	MUÑOZ	CHI
Gerald	CHENG	HKG	Mihail	PAGHIEV	MDA
Alberto	CORTEZ	MEX	Histor	RAMIREZ	COL
Angel	DIAZ	MEX	Natalia	RAMIREZ	COL
Florin-Sebastian	GHEORGE	ROU	Juan Carlos	RIOS RIVERA	MEX
Bruno	GIRON	PER	Carlos	VALENCIA	COL
Miguel	GRANDON	CHI	Luis Fernando	VELASCO	COL
Paulo	JUAN VELOSO	BRA	Suzanne	VOGT	CAN
Kelly	KOEHLER	USA			
Alexey	KUZNETSOV	CAN			

## RESULTS OF INDIVIDUAL EVENTS

WOMEN'S EPEE			
1	HU	Grace	CAN
2	JOYCE	Michaela	USA
3	CORREA SANTA	Carmen Andrea	COL
3	VIZEU	Victoria	BRA
5	GU	Sarah	USA
6	MORALES	Maria Fernanda	MEX
7	XIAO	Ruien	CAN
8	PIEDRAHITA GOMEZ	Alejandra	COL

MEN'S EPEE			
1	SILVERS	Noah	USA
2	IYOKI	Kent	USA
3	PEREZ ONDARTS	Lucio	ARG
3	LIVERANT	Skylar	USA
5	CANDELA	Nicholas	USA
6	SCHEMBRI	Kruz	ISV
7	ROJAS	Rafael Gerado	MEX
8	OJEDA BUITRAGO	Daniel	CRC

WOMEN'S FOIL			
1	PROESTAKIS	Katina	CHI
2	CHEN	Jessie	CAN
3	CAO	Arianna	USA
3	KIM	Katherine	USA
5	CALAZANS	Talia	BRA
6	TORRES	Jimena	MEX
7	CALDERON	Ana Sofia	MEX
8	GOMES	Rafaella	BRA

MEN'S FOIL			
1	EMMER	Chase	USA
2	KELLY	William	USA
3	GRIFFIN	John	USA
3	HAMILTON	Bogdan	CAN
5	FUKUDA	Alessio	PER
6	KASI	Sanjay	USA
7	ALARCON	David	CHI
8	WU	Nicholas Ze-Wei	CAN

WOMEN'S SABRE			
1	BOTELLO	Natalia	MEX
2	LEE	Alexandra	USA
3	CHIERIGHINI	Pietra	BRA
3	PAK	Kaitlyn	USA
5	GUZMAN	Mariana	MEX
6	PEKELMAN	Luana	BRA
7	PEDRAZA	Regina	MEX
8	TONG	Kunling	USA

MEN'S SABRE			
1	MOON	Sean	USA
2	MORRILL	William	USA
3	PINZON GUERRA	Alejandro	COL
3	LAI	Adam	USA
5	CHEN	Leo	CAN
6	FIGUEREDO SULIVERES	Adrian	PUR
7	GUALTERO CRUZ	Samuel	COL
8	WOODWARD	Connor Bryce	PUR



## RESULTS OF TEAM EVENTS

Women's epee		Men's epee		Women's foil		Men's foil		Women's sabre		Men's sabre	
1	USA	1	USA	1	USA	1	USA	1	USA	1	MEX
2	CAN	2	CHI	2	BRA	2	CAN	2	MEX	2	USA
3	COL	3	ARG	3	MEX	3	BRA	3	BRA	3	CAN
4	BRA	4	BRA	4	CAN	4	MEX	4	CAN	4	COL
5	MEX	5	MEX	5	CHI	5	PER	5	COL	5	BRA
6	CRC	6	COL	6	COL	6	ARG	6	CHI	6	ARG
7	CHI	7	CAN	7	PER	7	COL	7	PER	7	PUR
8	PUR	8	CRC	8	ARG	8	CHI			8	CHI

## MEDALS TABLE

	Gold	Silver	Bronze	Total
USA	8	6	6	20
MEX	2	1	1	4
CHI	1	1	0	2
CAN	1	3	2	6

	Gold	Silver	Bronze	Total
BRA	0	1	4	5
COL	0	0	3	3
ARG	0	0	2	2

## PARTICIPATION

Number of fencers 260

Number of countries 20

Weapons	Individuals	Teams
Women's epee	45	9
Men's epee	46	10
Women's foil	41	9
Men's foil	47	10
Women's sabre	38	7
Men's sabre	43	9

### 3.5.3.2. 2022 PANAMERICAN SENIOR CHAMPIONSHIPS

These championships were held in **Asunción (PAR) from 6th to 8th June 2022.**

The **officials** and **referees** appointed were as follows:

#### Officials:

Jose Gregorio	BENAVIDES	VEN	President of the Directoire Technique
Melissa	ALVARENGA	ESA	Member of the Directoire Technique
David	BLAKE	USA	Member of the Directoire Technique
Olga	COJOCARI	MDA	FIE Refereeing Commission Delegate
Maria Wilda	EBERL LOPEZ	CHI	FIE SEMI Commission Delegate
Nadia Judith	PAIVA GIMENEZ	PAR	Medical Delegate
Alberto Ramon	ESPINOLA JARA	PAR	Medical Delegate
Juan José	ARAUJO CAPPELLO	PAR	Medical Delegate

#### Referees:

Juan Pablo	BARBOSA	ARG	Yexis Niurvis	SALAZAR LEBOT	CUB
Martin Exequiel	LORA GRUNWALDT	ARG	David Isaac	BARRIOS	GUA
Fikrat	VALIYEV	AZE	Mihail	PAGHIEV	MDA
Lucio	BERTASO GOLDANI	BRA	Alberto	CORTES	MEX
Paulo Juan	VELOSSO	BRA	Angel	DIAZ	MEX
Alexey	KUZNETSOV	CAN	Juan Carlos	RIOS RIVERA	MEX
Suzanne	VOGT	CAN	Ever Augusto	COLMAN ORTELLADO	PAR
Miguel Angel	GRANDON FICA	CHI	Franco	ACQUADRO	URU
Alejandra	MUNOZ	CHI	Adam	BREWER	USA
Pilar Adriana	ARENAS GOMEZ	COL	Kelly	KOEHLER	USA
Carlos	VALENCIA MORA	COL	Daniel	CHACON	VEN
Luis Fernando	VELASCO PARRA	COL	Joselina	PINEDA	VEN
Daniela	JURADO SALAZAR	CRC	Joslyn	RODRIGUEZ	VEN
Michel	HERNANDEZ CUESTA MICHEL	CUB			

## RESULTS OF INDIVIDUAL EVENTS

WOMEN'S EPEE			
1	DI TELLA	Isabel	ARG
2	HOLMES	Katharine	USA
3	TEJEDA	Sheila Liliana	MEX
3	VIVEROS	Montserrat	PAR
5	MACKINNON	Leonora	CAN
6	VAN BRUMMEN	Anna	USA
7	DOIG CALDERON	Maria Luisa	PER
8	MENDEZ BELLO	Josefina Maria	ARG

MEN'S EPEE			
1	LIMARDO GASCON	Ruben	VEN
2	LUGO	Grabiél	VEN
3	LIMARDO	Francisco	VEN
3	GALLAGHER PELLETIER	Samuel	CAN
5	GARCIA	Eduardo	PER
6	MCDOWALD	Curtis	USA
7	SCHWANTES	Athos	BRA
8	CARRION ARCE	Dariel	CUB

WOMEN'S FOIL			
1	HARVEY	Eleanor	CAN
2	KIEFER	Lee	USA
3	DUBROVICH	Jacqueline	USA
3	GUO	Jessica Zi Jia	CAN
5	PROESTAKIS	Katina	CHI
6	RHODES	Zander	USA
7	FANG	Sabrina	CAN
8	PISTOIA	Mariana	BRA

MEN'S FOIL			
1	MASSIALAS	Alexander	USA
2	VAN HAASTER	Maximilien	CAN
3	MEINHARDT	Gerek	USA
3	ITKIN	Nick	USA
5	EMMER	Chase	USA
6	CERQUETTI	Dante Leonel	ARG
7	BROSZUS	Blake	CAN
8	SCHENKEL	Eli	CAN

WOMEN'S SABRE			
1	STONE	Anne-Elizabeth	USA
2	PAGE	Gabriella	CAN
3	RODRIGUEZ	Shia	VEN
3	THURGOOD	Madison	CAN
5	BOTELLO	Natalia	MEX
6	TARTAKOVSKY	Elizabeth	USA
7	PEREZ MAURICE	Maria Belen	ARG
8	TOLEDO	Julieta	MEX

MEN'S SABRE			
1	HOMER	Daryl	USA
2	DERSHWITZ	Eli	USA
3	DI TELLA	Pascual Maria	ARG
3	MACKIEWICZ	Andrew	USA
5	ARFA	Fares	CAN
6	ROMERO	Eliecer	VEN
7	QUINTERO	Jose	VEN
8	MONSALVA	Roberto	CHI

## RESULTS OF TEAM EVENTS

Women's epee		Men's epee		Women's foil		Men's foil		Women's sabre		Men's sabre	
1	USA	1	VEN	1	CAN	1	USA	1	USA	1	USA
2	VEN	2	COL	2	USA	2	CAN	2	CAN	2	CAN
3	CAN	3	ARG	3	CHI	3	BRA	3	BRA	3	COL
4	ARG	4	USA	4	BRA	4	ARG	4	VEN	4	BRA
5	MEX	5	CAN	5	MEX	5	VEN	5	MEX	5	VEN
6	BRA	6	CUB	6	COL	6	CHI	6	ARG	6	ARG
7	COL	7	BRA	7	ARG	7	MEX	7	COL	7	MEX
8	CRC	8	PAN	8	PER	8	COL	8	CHI	8	CHI

## MEDALS TABLE

	Gold	Silver	Bronze	Total
USA	7	4	4	15
CAN	2	5	4	11
VEN	2	2	2	6
ARG	1	0	2	3
COL	0	1	1	2

	Gold	Silver	Bronze	Total
BRA	0	0	2	2
MEX	0	0	1	1
PAR	0	0	1	1
CHI	0	0	1	1

## PARTICIPATION

Number of fencers 300

Number of countries 24

Weapons	Individuals	Teams
Women's epee	55	13
Men's epee	58	13
Women's foil	44	10
Men's foil	47	12
Women's sabre	47	11
Men's sabre	53	14

### 3.5.4 AFRICA

#### 3.5.4.1. 2022 AFRICAN JUNIOR CHAMPIONSHIPS

These championships were held in **Lagos (NGR) from 25th to 27th February 2022**.  
The **officials** and **referees** who officiated were as follows:

#### Officials:

Islam Bilel	HADI	ALG	President of the Directoire Technique
Akram	BOUNABI	ALG	Referee
Ahmed	AMR	EGY	Referee
Aya	HASHIM	EGY	Referee
Mostafa	MOATAZ	EGY	Referee
Pablo	ACEVEDO	ESP	Referee
Andreas	DOUVIS	GRE	Referee
Ehab	ABUSHKEWA	LBA	Referee
Louise	LOMBARD	RSA	Referee
Pape Mamadou	NDIAYE	SEN	Referee

## RESULTS OF INDIVIDUAL EVENTS

WOMEN'S EPEE			
1	GUEHAM	Maroua	ALG
2	TAREK	Salma	EGY
3	HUSSEIN	Aya	EGY
3	ZBOUDJ	Yousra	ALG
5	EMUSA	Natania	NGR
6	ABDELRAHMAN	Loulwa	EGY
7	ROUBET	Yasmine	ALG
8	MALEK	Leia Racha	ALG

MEN'S EPEE			
1	ELSAIED	Mohamed	EGY
2	ABDELBAKY.	An Amr	EGY
3	ALGADI	Abubaker Reda	LBA
3	ELSAIED	Mahmoud	EGY
5	YASSEEN	Mohamed	EGY
6	HOAREAU-BERKANI	Raphael Jacques	ALG
7	JORDAAN	Jaco	RSA
8	KRARIA	Mohamed Cherif	ALG

WOMEN'S FOIL			
1	KHALED	Lojain	EGY
2	MEBARKI	Meriem	ALG
3	HAMZA	Malak	EGY
3	ZBOUDJ	Sonia	ALG
5	ABDELHAMID	Aisha	EGY
6	RADWAN	Alia	EGY
7	BENCHEKOR	Selma Lilia	ALG
8	GUEMMAR	Chaima Nihal	ALG

MEN'S FOIL			
1	MADY	Yahia	EGY
2	FELLAH	Dani-Adam	ALG
3	FOUDA	Youssef	EGY
3	OSSAMA	Abdelrhman	EGY
5	TOLBA	Abdelrahman	EGY
6	DELLALI	Souheil	ALG
7	TAFUR	Alexander	RSA
8	ONOKPITE	Smith	NGR

WOMEN'S SABRE			
1	SALEH	Zeina	EGY
2	ABDALLAH	Dalya	EGY
3	ADEL ELDOKSH	Renad	EGY
3	SHOUMAN	Sara	EGY
5	BENCHEKOR	Naila	ALG
6	MOHAMED BELKEBIR	Kaouther	ALG
7	NASSOZI KIGGUNDU	Renee Gertrude	UGA
8	WONAME	Kelsey Victoria Afriyie	GHA

MEN'S SABRE			
1	HESHAM	Ahmed	EGY
2	MOATAZ	Adham	EGY
3	MADANI	Abdelhakim	ALG
3	NOFAL	Zeyad	EGY
5	BASSEM	Fares	EGY
6	SAAD	Youcef Abdelaziz	ALG
7	BOUNACEUR	Mohammed Belsem	ALG
8	BOUNCHADA	Zacharia	ALG

## RESULTS OF TEAM EVENTS

Women's epee		Men's epee		Women's foil		Men's foil		Women's sabre		Men's sabre	
1	EGY	1	EGY	1	EGY	1	EGY	1	EGY	1	EGY
2	ALG	2	LBA	2	ALG	2	ALG	2	ALG	2	ALG
3	SEN	3	ALG	3	NGR	3	NGR	3	SEN	3	SEN
4	NGR	4	SEN					4	NGR	4	NGR
		5	NGR								

## MEDALS TABLE

	Gold	Silver	Bronze	Total
EGY	11	4	8	23
ALG	1	7	4	12
LBA	0	1	1	2
SEN	0	0	3	3
NGR	0	0	2	2

## PARTICIPATION

Number of fencers 78

Number of countries 10

Weapons	Individuals	Teams
Women's epee	16	4
Men's epee	19	5
Women's foil	11	3
Men's foil	10	3
Women's sabre	11	4
Men's sabre	11	4

### 3.5.4.2. 2022 AFRICAN SENIOR CHAMPIONSHIPS

These championships were held in **Casablanca (MAR) from 15th to 19th June 2022.**

The **officials** and **referees** who officiated were as follows:

#### Officials:

Hassene	ZOUARI	TUN	President of the Directoire Technique
Rachid	MAFTOUH	MAR	Member of the Directoire Technique
Mohamed	NAHI	MAR	General Director
Rachid	MAFTOUH	MAR	Competition Manager
Essadiqi	OTHMAN	MAR	Doctor
Abdelaziz	EL FALJI	MAR	SEMI delegate

#### Referees:

Bilel Islam	HADI	ALG
Luigi	MARTILOTTI	ITA
Tim	BARDENHAGEN	GER
Jean	KONAN KOUAKOU	CIV
Ahmed	AMR	EGY
Mostafa	MOATAZ	EGY
Nabil	RIAD	MAR
Issa Keletigui	COULIBALY	MLI
Louise	LOMBARD	RSA
Baytir Sidy	DIOP	SEN
Pape Mamadou	NDIAYE	SEN
Hichem	SAMANDI	TUN



## RESULTS OF INDIVIDUAL EVENTS

WOMEN'S EPEE			
1	EHAB	Nardin	EGY
2	GABER	Shirwit	EGY
3	DIONGUE	Ndeye Binta	SEN
3	HUSSEIN	Aya	EGY
5	EL KORD	Camilia	MAR
6	BOUSFIHA	Chloe	MAR
7	TUKU	Aphiwe	RSA
8	SABALY	Aminata	SEN

MEN'S EPEE			
1	ELSAIED	Mohamed	EGY
2	ELSOKKARY	Ahmad	EGY
3	BEUGRE	Bedi Paul Alex	CIV
3	SANER	Harry	RSA
5	YASSEEN	Mohamed	EGY
6	TYCHLER	Pavel	RSA
7	LOSEVSKIY	Sergey	RSA
8	HOAREAU-BERKANI	Raphael Jacques	ALG

WOMEN'S FOIL			
1	MOHAMED	Nora	EGY
2	ZAKARANI	Youssra	MAR
3	ELSHARKAWY	Yara	EGY
3	HANY	Noha	EGY
5	MEBARKI	Meriem	ALG
6	GUEMMAR	Chaima Nihal	ALG
7	B'CHIR	Nourane	TUN
8	ELZOHEIRY	Mariam	EGY

MEN'S FOIL			
1	ABOUELKASSEM	Alaaeldin	EGY
2	HAMZA	Mohamed	EGY
3	HASSAN	Mohamed	EGY
3	MADI	Youcef	ALG
5	KERYHUEL	Jeremy Fafa	CIV
6	METOUJ	Mohamed Aziz	TUN
7	ESSAM	Mohamed	EGY
8	ALVARES DE OLIVEIRA	Victor	CPV

WOMEN'S SABRE			
1	KEHLI	Zohra Nora	ALG
2	HAFEZ	Nada	EGY
3	BOUDIAF	Saoussen	ALG
3	DEGHIEDY	Mariam	EGY
5	DAGHFOUS	Yasmine	TUN
6	BOUNGAB	Abik	ALG
7	SARAA	Manal	MAR
8	FERJANI	Rania	TUN

MEN'S SABRE			
1	FERJANI	Fares	TUN
2	MOATAZ	Medhat	EGY
3	AMER	Mohamed	EGY
3	FERJANI	Ahmed	TUN
5	MOATAZ	Adham	EGY
6	ELSISSY	Ziad	EGY
7	HMISSI	Amenallah	TUN
8	GIRAULT	Evann Jean Abba	NIG

## RESULTS OF TEAM EVENTS

Women's epee		Men's epee		Women's foil		Men's foil		Women's sabre		Men's sabre	
1	EGY	1	EGY	1	EGY	1	EGY	1	ALG	1	TUN
2	MAR	2	MAR	2	ALG	2	ALG	2	TUN	2	EGY
3	ALG	3	RSA	3	MAR	3	TUN	3	EGY	3	ALG
4	SEN	4	SEN	4	CIV	4	CIV	4	MAR	4	MLI
		5	ALG			5	GHA	5	CIV	5	SEN
		6	TUN			6	MAR	6	SEN	6	CIV
		7	LBA							7	MAR
		8	CIV								
		9	GHA								

## MEDALS TABLE

	Gold	Silver	Bronze	Total
EGY	8	6	7	21
ALG	2	2	4	8
TUN	2	1	2	5
MAR	0	3	1	4

	Gold	Silver	Bronze	Total
RSA	0	0	2	2
SEN	0	0	1	1
CIV	0	0	1	1

## PARTICIPATION

Number of fencers 138

Number of countries 17

Weapons	Individuals	Teams
Women's epee	24	4
Men's epee	31	9
Women's foil	15	4
Men's foil	24	6
Women's sabre	21	6
Men's sabre	30	7

### 3.6 2022 MEDITERRANEAN GAMES

The Mediterranean Games were held in **Oran (ALG) from 3rd to 5th July 2022**.

The **officials** and **referees** appointed by the FIE were as follows:

#### Officials:

Velichka	HRISTEVA	BUL	Technical Delegate
Dieter	LAMMER	GER	President of the Directoire Technique
Islam Bilel	HADI	ALG	Member of the Directoire Technique
Abdelkader	SAIDI	ALG	Member of the Directoire Technique
Aida	KHASANOVA	UZB	Member of the FIE Refereeing Commission
Baiba	BRANDULE	LAT	Member of the FIE SEMI Commission

#### Referees:

Roman	BEREUTER	AUT
Mihail	PAGHIEV	MDA
Ahmed	IBRAHIM	EGY
Abdussamet	ARSLAN	TÜR
Yann	MARPEAUX	FRA
Pietro	FREZZA	ITA
Andreas	DOUVIS	GRE
Pablo	ACEVEDO ROYER	ESP
Nabil	RIAD	MAR
Miljan	KOVACEVIC	SRB
Ehab	ABUSHKEWA	LBA
Ahmed	MAMDOUH ALY	EGY
Nacim Islam	BERNAOUI	ALG
Khadidja	ZERABIB	ALG
Nassim	DERRAGUI	ALG
Zakaria Ameer	TAHIR	ALG

## RESULTS OF INDIVIDUAL EVENTS

WOMEN'S EPEE			
1	RIZZI	Giulia	ITA
2	FOIETTA	Nicol	ITA
3	MARZANI	Roberta	ITA
3	VANRYSSEL	Eloise	FRA
5	VITALIS	Coraline	FRA
6	LOUIS MARIE	Alexandra	FRA
7	GRIJAK	Jana	SRB
8	FERNANDEZ CALLEJA	Sara	ESP

MEN'S EPEE			
1	ELSAIED	Mohamed	EGY
2	CUOMO	Valerio	ITA
3	TAGLIARIOL	Matteo	ITA
3	PAOLINI	Giacomo	ITA
5	YASSEEN	Mohamed	EGY
6	JERENT	Daniel	FRA
7	ALLEGRE	Paul	FRA
8	ELSOKKARY	Ahmad	EGY

WOMEN'S FOIL			
1	CALISSI	Olga Rachele	ITA
2	PATRU	Morgane	FRA
3	DIAZ ESCALONA	Maria Teresa	ESP
3	KARAMETE	Irem	TÜR
5	CIPRESSA	Erica	ITA
6	MARINO	Maria	ESP
7	BATINI	Martina	ITA
8	ISBIR	Alisa	TÜR

MEN'S FOIL			
1	CUK	Veljko	SRB
2	LLAVADOR	Carlos	ESP
3	FILIPPI	Davide	ITA
3	HAMZA	Mohamed	EGY
5	LUPERI	Edoardo	ITA
6	BIANCHI	Guillaume	ITA
7	ELICE	Meddy	FRA
8	ABOUELKASSEM	Alaaeldin	EGY

WOMEN'S SABRE			
1	BOUDIAF	Saoussen	ALG
2	MORMILE	Chiara	ITA
3	GARGANO	Rebecca	ITA
3	PASSARO	Eloisa	ITA
5	VONGSAVADY	Malina	FRA
6	LEMBACH	Charlotte	FRA
7	MARTIN PORTUGUES	Lucia	ESP
8	SHCHUKLA	Iryna	TÜR

MEN'S SABRE			
1	ELSISSY	Ziad	EGY
2	NUCCIO	Riccardo	ITA
3	CAVALIERE	Dario	ITA
3	BRAVO	Inaki	ESP
5	REPETTI	Giovanni	ITA
6	AHMER	Mohamed	EGY
7	FERJANI	Fares	TUN
8	MOATAZ	Adham	EGY

### MEDALS TABLE

	Gold	Silver	Bronze	Total
ITA	2	4	7	13
EGY	2	0	1	3
ALG	1	0	0	1
SRB	1	0	0	1

	Gold	Silver	Bronze	Total
ESP	0	1	2	3
FRA	0	1	1	2
TÜR	0	0	1	1

### PARTICIPATION

Number of fencers 108

Number of countries 16

Weapons	Individuals
Women's epee	17
Men's epee	25
Women's foil	15
Men's foil	18
Women's sabre	15
Men's sabre	19



To the Congress of members of the  
**Fédération Internationale d'Escrime, Lausanne**

Lausanne, 20 June 2023

## **Auditors' report on the limited audit**

In our capacity as auditor, we have checked the annual accounts (balance sheet, income statement and annexes to the financial statements) of the Fédération Internationale d'Escrime for the financial year ending 31 December 2022.

Responsibility for drawing up the annual accounts rests with management, whereas our task is to audit those accounts. We confirm our compliance with the legal requirements regarding approval and independence.

Our audit was carried out according to the Swiss standard relating to a limited audit. This standard requires the audit to be planned and conducted in such a way that significant anomalies in the annual accounts may be ascertained. A limited audit primarily consists of hearings, analytical audit operations and appropriate detailed checks of the documents available in the audited company. However, checks of operating flow and the internal auditing system as well as other audit operations and hearings aimed at detecting fraud or other breaches of the law do not form part of this audit.

In the course of our audit, we did not encounter anything to lead us to conclude that the annual accounts do not comply with the law and statutes.

Ernst & Young SA



Alfred  
Widmann  
(Qualified  
Signature)

Senior Auditor  
(Audit Manager)



Pascal Tréhan  
(Qualified  
Signature)

Senior Auditor

### **Attached**

- ▶ Annual accounts (balance sheet, income statement and annexes to the financial statement)

# FINANCIAL REPORT

2022



## FINANCIAL REPORT 2022

On 19 June 2023

Mr. President,  
Ladies and Gentlemen, Members of Honour,  
Members of the Executive Committee,  
Presidents of the Federations,  
Ladies and Gentlemen, Congress participants,

I am pleased to submit for your approval the balance sheet and income statements for the financial year 2022 (1<sup>er</sup> January to 31 December), together with the budget for the year 2024 (1<sup>er</sup> January to 31 December).

### 1. INCOME STATEMENTS

#### SUMMARY

The income and expenditure accounts for the financial period submitted for your approval show a difference between revenue and expenditure of **CHF -6,757,552** from capital and a capital of **CHF 29,595,641**.

#### EXPENSES

##### Total administrative and financial expenses:

	<b>CHF</b>	<b><u>2 736 389</u></b>	;	10,66 %	<i>below budget.</i>
1) Payroll expenses	<b>CHF</b>	<b>1 216 283</b>	;	17,81 %	<i>below budget.</i>
2) Administrative expenses		<b>455 170</b>	;	0,03 %	<i>over budget.</i>

The main categories are :

• Office rental	<b>CHF</b>	124 236
• Fees	<b>CHF</b>	140 636
• Translation services	<b>CHF</b>	55 027
• IT	<b>CHF</b>	39 233
• Various insurances	<b>CHF</b>	37 509

3) Organisation of the FIE Congress in Lausanne	<b>CHF</b>	<b>416 470</b>	;	38.82 %	<i>over budget.</i>
---	------------	----------------	---	---------	---------------------

All the costs of the 2022 Congress in Lausanne were borne by the FIE, which explains the budget overrun.

The main categories are :

• Plane tickets	CHF	98 200
• Hotel	CHF	68 470
• Transport	CHF	25 800
• Security	CHF	18 000
• Covid tests	CHF	7 080
• SwissTech, venue renting and meals	CHF	101 782
• Olympic Museum	CHF	46 440

4) Bureau and Executive Committee (meetings) CHF 194 790 ; 2,52 % *over budget.*

The main categories are :

• Executive Committee meetings	CHF	94 966
• Executive Committee travel expenses	CHF	64 980
• Executive Committee per diem	CHF	28 315

5) Executive Committee and staff travel (WCH) CHF 103 570 ; 3,57 % *over budget.*

6) Commissions and Councils CHF 78 849 ; 67,14 % *below budget.*

Including

• Refereeing Commission	CHF	39 896
• Special Commission	CHF	5 680

7) Anti-doping management services, out-of-competition testing and promotion of anti-doping CHF 158 292 ; 39,11 % *below budget.*

**Total financial expenses :** CHF **112 472** ; 240,82 % *over budget.*

• Foreign exchange losses	CHF	-
• Financial expenses	CHF	97 724
• Amortisation	CHF	14 748
• Provisions / losses on receivables	CHF	-

Financial expenses come from account management fees, investment fees and bank payment fees.

**Total Sport Department expenses:**

CHF **2 520 292** ; 23,69 % *below budget.*

1) Subsidies to Confederations CHF 240 000 ; *in the budget.*

2) Equipment for Federations CHF 594 971 ; 0,83 % *below budget.*

• Africa	CHF	135 078		23 federations
• Americas	CHF	146 138		25 federations
• Asia	CHF	158 941		25 federations
• Europe	CHF	138 641		24 federations
• Oceania	CHF	16 173		3 federations

A total of 100 national federations have benefited from the equipment support programme.

3) Schools, training for fencing masters

CHF 519 423 ; 35,87 % *below budget.*

• Africa	CHF	109 635
• Americas	CHF	118 779
• Asia	CHF	119 383
• Europe	CHF	157 445
• Oceania	CHF	14 181

4) World Championships training camp

CHF 120 901 ; 20,90 % *over budget.*

The budget overrun is due to the increasing cost of plane tickets.

5) Refereeing: examinations, seminars, bonuses

CHF 194 594 ; 55,77 % *below budget.*

6) Aid to Federations (1+1+1)

CHF 465 958 ; 2,92 % *below budget.*

7) Junior/Cadet World Championship

CHF 108 229 ; 8,22 % *over budget.*

8) Senior/Veteran World Championship

CHF 87 767 ; 28,64 % *below budget.*

9) Grand Prix, World Cups, Zonal Championships

CHF 41 917 ; 44,11 % *below budget.*

10) Service providers

CHF 59 356 ; 20,85 % *below budget.*

11) Athlete career programme

CHF -

12) Confederation Sports Directors

CHF 72 000 ; 40,00 % *below budget.*

13) Projects

CHF 15 176 ; 83,13 % *below budget.*

**Total Communication/Marketing/TV department expenses:**

**CHF 1 223 272 ; 56,18 % *below budget.***

1) Video portal/ Digital content / Website	<b>CHF</b>	<b>141 645</b>	<b>;</b>	<b>59,53</b>	<b>%</b>	<i>below budget.</i>
• Digital content / Video portal	<b>CHF</b>	116 495				
• Website	<b>CHF</b>	25 150				
2) Magazines	<b>CHF</b>	<b>46 788</b>	<b>;</b>	<b>68,80</b>	<b>%</b>	<i>below budget.</i>
3) Communication	<b>CHF</b>	<b>55 690</b>	<b>;</b>	<b>20,44</b>	<b>%</b>	<i>below budget.</i>
4) Marketing	<b>CHF</b>	<b>79 545</b>	<b>;</b>	<b>0,56</b>	<b>%</b>	<i>below budget.</i>
5) Events	<b>CHF</b>	<b>181 987</b>	<b>;</b>	<b>62,08</b>	<b>%</b>	<i>below budget.</i>
6) Service providers	<b>CHF</b>	<b>153 221</b>	<b>;</b>	<b>8,66</b>	<b>%</b>	<i>over budget.</i>
7) TV broadcast (Eurosport)	<b>CHF</b>	<b>564 395</b>	<b>;</b>	<b>62,89</b>	<b>%</b>	<i>below budget.</i>

Contract with Eurosport has been renegotiated, resulting in a significant reduction in costs.

**Total exceptional aid:**

**CHF**    **1 221 737** ;    **20,71** %    *below budget.*

1) Exceptional aid for organisers

**CHF**    **674 737** ;

2) Swisstiming

**CHF**    **547 000** ;

**Total expenses for the FIE was CHF 7,741,541, with a revaluation of foreign currencies of CHF 210,322.**

## EXPENSES

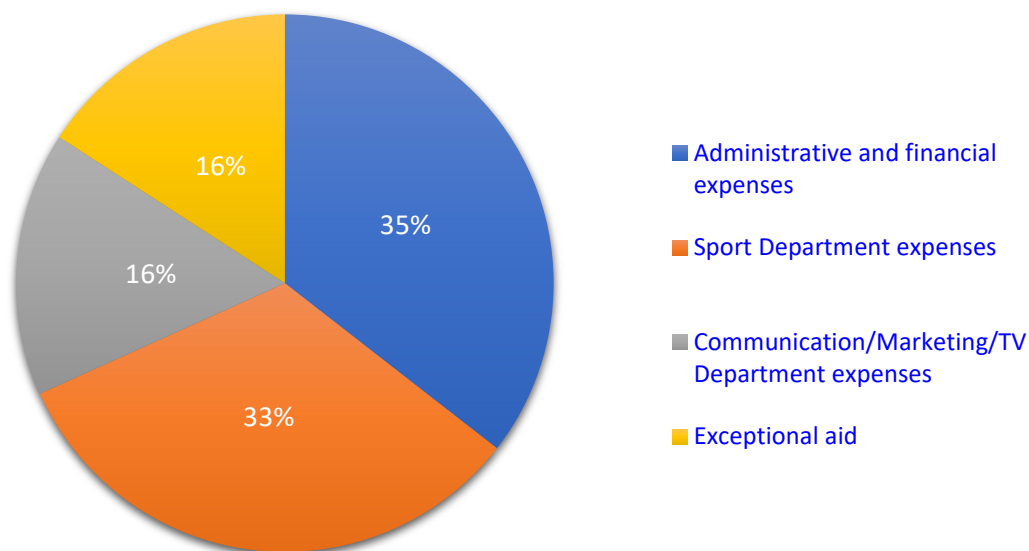

## REVENUE

1) Donations :	CHF	-		
2) Revenue from Federations	CHF	349 863 ;	13,22 %	over budget.
Including :				
• Federations' annual fees	CHF	55 130 ;	3,28 %	below budget.
• Organisation fees (GP, CM)	CHF	33 328 ;		
• International licences	CHF	169 457 ;	15,27 %	below budget.
• Referee examination fees	CHF	9 771 ;	18,57 %	below budget.
• Other revenue	CHF	82 176 ;	205,44 %	over budget.
3) Finance and provisions	CHF	475 557 ;	851,11 %	over budget.

Including :

• Financial income	CHF	46 887 ;	6,22 %	<i>below budget.</i>
• Foreign exchange gains	CHF	210 322 ;		
• Income from previous years	CHF	218 348 ;		
• Release of provisions	CHF	-		

4) IOC-	CHF	66 570 ;	0,93 %	<i>below budget.</i>
• IOC development aid subsidy	CHF	66 570 ;	0,93 %	<i>below budget.</i>

5) Communication/Marketing/TV	CHF	92 000 ;	15,00 %	<i>over budget.</i>
-------------------------------	-----	----------	---------	---------------------

Including

• Escribe magazine	CHF	26 944 ;	51,01 %	<i>below budget.</i>
• Sponsorship	CHF	-		
• Television rights	CHF	65 056 ;	160,22 %	<i>over budget.</i>

Total revenue was **CHF 983,990**, 90.80% below budget.

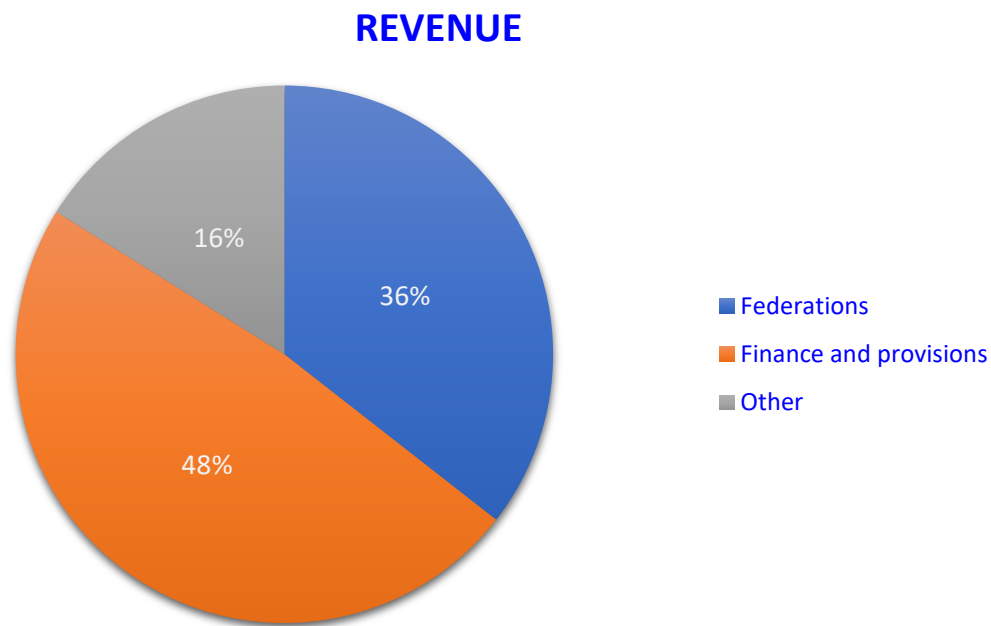

**BALANCE SHEET:** Our total capital is CHF 29,595,641

**ASSETS :**

Current assets :

1) Cash (cash funds, bank balances and term accounts)	CHF	29 379 083
---	-----	------------

2) Stock (ties, scarves, flags)	CHF	12 489
3) Receivables from federations	CHF	20 792
4) Other customers	CHF	44 984
5) Accrued income	CHF	4 308
6) Prepaid expenses	CHF	123 439

**Total current assets :** CHF 29 585 094

Fixed assets :

1) Tangible fixed assets	CHF	10 547
• Office and IT equipment	CHF	2 882
• Office furniture	CHF	0
• Sports equipment	CHF	0
• General equipment	CHF	7 665
2) Financial fixed assets	CHF	0
3) Intangible fixed assets	CHF	0

**Total fixed assets :** CHF 10 547

**Total assets: CHF 29,595,641**

LIABILITIES :

1) The capital as at 01.01.2022 (CHF 15,286,078) represents the FIE's financial position at the beginning of the financial year.

The negative balance between income and expenses of CHF 6,757,552 is the result of the profit and loss account.

• Capital as at 31 December 2022	CHF	15 286 078
• Loss for the year	CHF	6 757 552
• Long-term reserve	CHF	20 000 000

Total equity amounted to CHF 28,528,526.

2) Suppliers and accrued liabilities

• Suppliers	CHF	268 296
• Accrued liabilities	CHF	798 818
• Income received in advance	CHF	0
• Other creditors	CHF	0

Total short-term capital amounted to CHF 1,067,114.

**Total liabilities: CHF 29,595,641**

I would like to thank my colleagues on the Executive Committee, all the FIE staff and especially Sandra Baroni, our Accounting Manager, for her invaluable help.

Recognition and thanks also to Ms Nathalie Rodriguez, our CEO, who in 2022 celebrated thirty years with the International Fencing Federation, for all that she continues to contribute to our Federation.

Ferial Salhi  
Secretary Treasurer



FEDERATION INTERNATIONALE D'ESCRIME

LAUSANNE

BALANCE SHEET

<b>ASSETS</b>	<b>31.12.2022</b>	<b>31.12.2021</b>
	<b>CHF</b>	<b>CHF</b>
Cash funds	42 637	37 198
Bank balances	7 347 287	35 585 118
Securities	21 989 159	0
<b>Treasury</b>	<b>29 379 083</b>	<b>35 622 316</b>
Receivables from federations	20 792	20 971
Other short-term receivables	44 984	16 739
Stocks	12 489	15 824
Accrued income (net)	4 308	1 253 237
Prepaid expenses	123 439	67 278
<b>Accruals - assets</b>	<b>127 747</b>	<b>1 320 515</b>
<b>Current assets</b>	<b>29 585 094</b>	<b>36 996 365</b>
Office and IT equipment	2 882	3 762
General facilities	7 665	17 884
<b>Tangible fixed assets</b>	<b>10 547</b>	<b>21 646</b>
<b>Fixed assets</b>	<b>10 547</b>	<b>21 646</b>
<b>Total assets</b>	<b>29 595 641</b>	<b>37 018 011</b>

INTERNATIONAL FENCING FEDERATION

LAUSANNE

BALANCE SHEET

LIABILITIES	31.12.2022 CHF	31.12.2021 CHF
Debts arising from the purchase of services	268 296	236 284
Other short-term liabilities (VAT payable)	0	458 304
Accruals - liabilities	798 818	1 037 346
	<hr/>	<hr/>
<b>Foreign short-term capital</b>	<b>1 067 114</b>	<b>1 731 933</b>
	<hr/>	<hr/>
Initial capital	15 286 078	2 656 059
Loss for the year	-6 757 552	12 630 019
<b>Final capital</b>	<b>8 528 526</b>	<b>15 286 078</b>
Reserve fund	20,000,000	20,000,000
	<hr/>	<hr/>
<b>Total equity</b>	<b>28 528 526</b>	<b>35 286 078</b>
	<hr/>	<hr/>
<b>Total liabilities</b>	<b>29 595 641</b>	<b>37 018 011</b>
	<hr/>	<hr/>

INTERNATIONAL FENCING FEDERATION

LAUSANNE

INCOME STATEMENT

	Notes	2022 CHF	2021 CHF
Donations	5	0	6 534 500
Net income from Federations	6	349 862	53 082
IOC contributions	8	66 570	178 182
Olympics revenue	9	0	13 889 878
Communication and marketing products	10	92 000	19 536
<b>TOTAL INCOME</b>		<b>508 432</b>	<b>20 675 177</b>
Salaries		-1 081 342	-1 280 281
Social security charges		-157 747	-187 237
Other staff costs		-5 492	-19 204
<b>Staff costs</b>	<b>1.1 + 1.C</b>	<b>-1 244 581</b>	<b>-1 486 722</b>
Operating expenses	1.2	-455 170	-415 000
Organisation of the Congress	1.3	-416 470	-588 836
Bureau and Executive Committee	1.4	-194 790	-163 155
Travels of the Executive Committee	1.5	-103 571	-48 202
Commissions and Councils	1.6	-78 849	-4 011
Anti-doping	1.7	-158 292	-187 953
<b>Administrative expenses</b>		<b>-1 407 142</b>	<b>-1 407 158</b>
Sport expenses	2	-2 520 292	-1 739 288
Communication and marketing expenses	3	-1 223 271	-1 219 295
Tokyo Olympics		0	-529 801
Global Support Plan	4	-1 221 737	-1 599 193
<b>EARNINGS BEFORE INTEREST, TAXES, DEPRECIATION AND AMORTISATION (EBITDA)</b>		<b>-7 108 591</b>	<b>12 693 720</b>
Amortisation	1.8	-14 748	-23 516
Provision for losses on receivables	1.10	-494	-102 495
Interest and bank charges	1.9	-97 724	-15 588
Losses on financial investments	1.9.1	-301 305	
<b>Financial expenses</b>		<b>-399 029</b>	<b>-15 588</b>
Bank interest	7.1	42	4 247
Interest on financial investments	7.1	259 486	0
Gains on financial investments	7.1	88 664	0
Gains on financial investments	7.2	210 322	46 785
Net foreign exchange gain (revaluation)	7	558 514	51 032
<b>Financial income</b>			
Exceptional expenses	4Bis	-11 552	-22 743
Extraordinary income	7.3	218 348	49 609
<b>Exceptional result</b>	<b>4Bis + 7.3</b>	<b>206 796</b>	<b>26 866</b>
<b>RESULT FOR THE YEAR</b>		<b>-6 757 552</b>	<b>12 630 019</b>

# INTERNATIONAL FENCING FEDERATION

## LAUSANNE

### NOTES TO THE FINANCIAL STATEMENTS AT 31 DECEMBER 2022

#### 1. Accounting policies applied and not prescribed by law :

- 1.1. The Fédération Internationale d'Escrime (hereinafter the "FIE") is a non-governmental, non-profit-making international organisation, having the legal form of an association under Swiss law, with its registered office in Lausanne, Switzerland.

It is recognised by the International Olympic Committee (IOC) as the world governing body for fencing. The FIE lays down the rules governing the organisation of international competitions and supervises their application.

- 1.2. The financial statements are presented in Swiss francs (CHF) in accordance with the accounting standards governed by the Swiss Code of Obligations, the regulations and statutes of the FIE and the accounting methods set out below.

- 1.3. *Investment securities*

*Investment securities are managed by a recognised banking institution and are marked to market daily.*

- 1.4. *Items denominated in foreign currency*

Transactions in foreign currencies are converted into Swiss francs (CHF) at the exchange rate in effect at the time they are made. Monetary assets and liabilities denominated in foreign currencies are converted at the exchange rate in effect on the year-end date.

The rates applicable to the balance sheet below correspond to the year-end rates at 31 December 2022:

	31.12.2022	31.12.2021
	CHF	CHF
EUR/CHF	<u>0,9858</u>	<u>1.0363</u>
USD/CHF	<u>0,9234</u>	<u>0,9151</u>

- 1.5. *Federations and other short-term receivables*

Receivables from Federations and other short-term receivables are carried at their nominal value. Individual value corrections are made, with the residual balance being subject to a flat-rate value correction of 5% and 10%.

- 1.6. *Stocks*

Stocks are valued at acquisition cost or production cost. The acquisition cost and production cost of stocks are determined using the weighted cost method.

**INTERNATIONAL FENCING FEDERATION**

**LAUSANNE**

**NOTES TO THE FINANCIAL STATEMENTS AT 31 DECEMBER 2022**

**1.7. Tangible fixed assets**

Tangible fixed assets are recognised in the balance sheet at their historical cost, after deduction of the accumulated depreciation. Depreciation is calculated using the straight-line method. Any immediate depreciation are recognised within the tax deductibility limits allowed, on the basis of a decision by the Treasurer.

Depreciation rates are set on estimated useful life:

Office equipment and IT	Between 2 and 3 years
Office furniture	4 years
Sports equipment	5 years
General facilities	Between 3 and 5 years
Media	3 years

**2. Information and comments on the main balance sheet and income statement items :**

<b>2.1. Cash balances by currency</b>	<b>31.12.2022</b>	<b>31.12.2021</b>
	<b>CHF</b>	<b>CHF</b>
CHF	6 746 635	8 345 387
HUF, 6'160	15	17
EUR, 539,012.36	531 358	7 144 719
USD, 119,570.06	110 411	20 129 509
AED, 3,187.90	801	0
EGP, 5,746.59	214	0
JPY	0	2 413
GBP, 440	490	272
	<u>7 389 924</u>	<u>35 622 316</u>

<b>2.2. Securities by currency</b>	<b>31.12.2022</b>	<b>31.12.2021</b>
	<b>CHF</b>	<b>CHF</b>
CHF	1 000 000	0
EUR, 4,950,815.10	4 880 514	0
USD, 17,444,927.32	16 108 646	0
	<u>21 989 159</u>	<u>0</u>

**2.3. Income statement**

The breakdown of the headings is provided in the attached table, with the annual budget for comparison.

INTERNATIONAL FENCING FEDERATION

LAUSANNE

NOTES TO THE FINANCIAL STATEMENTS AT 31 DECEMBER 2022

2.3.1 Exceptional expenses 2021 :

These are the waiver of the Federation of Canada's debts of KChf 5, the entry in the accounts of current advance from the Romanian Federation of KChf 11 and an invoice for the World Cup of Luxembourg of March 2020 received in October 2021 of KChf 7.

Exceptional income from previous years 2021 :

These include the reversal of the 2017 FE-ITA provision of KChf 21, the reversal of the aid plan of 2020 by KChf 1, the cancellation of the M Elbakry invoice for 2018 by KChf 5, the reversal of the 2020 anti-doping provision of KChf 5, the reimbursement of Favero for material assistance 2020 of KChf 8 and the grant for the WCH JC 2020 from the Conf. European KChf 10.

Expenses from previous years/ exceptional expenses for 2022 :

This includes the waiver of costs relating to the 2022 YOG and 2018-19 annual fees KChf 3, invoices for services 2021 not received for KChf 9.

Income from previous years /exceptional income 2022

Waiver of the 2020 global aid plan, reimbursement of airline tickets for the Tokyo Olympics, 2021 and 2010 heating bills, correction of LAA and IND rates for KChf 16, reversal of provisions for athletes and 2021 equipment aid of KChf 203.

**3. Average annual number of full-time jobs :**

On an annual average, the number of full-time jobs is between 10 and 20 people.

31.12.2022	31.12.2021
CHF	CHF

**4. Leasing and other long-term commitments  
non-cancellable :**

Commercial lease expiring on 30 September 2026, not recognised on the balance sheet

468 117	592 948
---------	---------

31.12.2022	31.12.2021
CHF	CHF

**5. Liabilities to pension and welfare funds :**

0	22 789
---	--------

**2. INCOME STATEMENT FROM 1 JANUARY TO 31 DECEMBER 2022**

**SWISS FRANCS (CHF)**

	EXPENSES			REVENUE	
	Jan/Dec 2022	Jan/Dec 2022		Jan/Dec 2022	Jan/Dec 2022
	Budget 2022	Expenses 2022		Budget 2022	Revenue 2022
<b>1A. Administration</b>	<b>3 063 000</b>	<b>2 638 172</b>	<b>5. Donations</b>	<b>5 000 000</b>	<b>-</b>
1.1 Payroll expenses	1 480 000	1 216 283	5.1 Donations	5 000 000	-
1.2 Operating expenses	455 000	455 170			
1.3 Organisation of the Congress/participation of the President of each NF in the Congress	300 000	416 470			
1.4 Bureau and Executive Committee	190 000	194 790	<b>6. Federations</b>	<b>309 000</b>	<b>349 862</b>
1.5 Executive Committee and staff travel to WCH	100 000	103 571	6.1 Federation annual fees	57 000	55 130
1.6 Commissions and Councils	240 000	78 849	6.2 Organisation fees	-	33 328
1.7 Anti-doping	260 000	158 292	6.3 International licences	200 000	169 457
1.8 Amortisation	8 000	14 748	6.4 Referee examination fees	12 000	9 771
<b>1B. Finance and provisions</b>		<b>399 523</b>	6.5 Other revenue	40 000	82 176
1.9 Bank financial expense	25 000	97 724			
1.9.1 Financial expenses - Lombard Odier investments	-	301 305			
1.10 Provisions/losses on receivables	5 000	494			
<b>1C. Provision for holidays and overtime</b>		<b>28 297</b>			
<b>2. Sport</b>	<b>3 303 000</b>	<b>2 520 292</b>	<b>7. Finance and provisions</b>	<b>50 000</b>	<b>776 862</b>
2.1 Subsidies to confederations	240 000	240 000	7.1 Financial income	50 000	348 193
2.2 Equipment for federations	600 000	594 971	7.2 Net foreign exchange gain (revaluation)	-	210 322
2.3 Schools, training for Fencing masters	810 000	519 423	7.3 Income from previous years	-	218 348
2.4 Championships training camps	100 000	120 901			
2.5 Refereeing (examinations, seminars, bonuses)	440 000	194 594			
2.6 Aid to federations	480 000	465 958			
2.7 J/C World Championships	100 000	108 229	<b>8. IOC</b>	<b>67 200</b>	<b>66 570</b>
2.8 Senior/Veteran World Championships	123 000	87 767	8.1 IOC development aid grant	67 200	66 570
2.9 World Cups, GP, ZCH	75 000	41 917			
2.10 Service providers	75 000	59 356			
2.11 Athlete career programme	50 000	-	<b>9. Revenue from the Olympic Games</b>	<b>-</b>	<b>-</b>
2.12 Confederation sports directors	120 000	72 000			
2.13 Projects	90 000	15 176			
<b>3. Com/Mkt/TV</b>	<b>2 792 000</b>	<b>1 223 271</b>	<b>10. Com/Mkt/TV</b>	<b>80 000</b>	<b>92 000</b>
3.1 Video portal / Digital content / Website	350 000	141 645	10.1 Escrime magazine	55 000	26 944
3.2 Magazines	150 000	46 788	10.2 Sponsorship	-	-
3.3 Communication	70 000	55 690	10.3 Television rights	25 000	65 056
3.4 Marketing	80 000	79 545			
3.5 Events	480 000	181 987			
3.6 Service providers	141 000	153 221	<b>11. Other revenue (reserve)</b>	<b>5 192 800</b>	<b>-</b>
3.7 Specific projects	-	-			
3.8 TV Broadcast (Eurosport, CNN)	1 521 000	564 395			
<b>4. FIE 2021-2022 support for organisers</b>	<b>1 541 000</b>	<b>1 221 737</b>			
<b>4. Bis Previous years' expenses (invoices received after the accounts have been closed)</b>		<b>11 552</b>			
<b>SUB-TOTAL</b>	<b>10 699 000</b>	<b>8 042 846</b>	<b>SUB-TOTAL</b>	<b>10 699 000</b>	<b>1 285 294</b>
<b>12. Income surplus</b>			<b>13. Expenses surplus</b>		<b>6 757 552</b>
<b>TOTAL</b>	<b>10 699 000</b>	<b>8 042 846</b>	<b>TOTAL</b>	<b>10 699 000</b>	<b>8 042 846</b>

**FINANCIAL STATEMENTS (REVENUE AND EXPENSES) AS PER BUDGET FROM 1 JANUARY 2022 TO 31 DECEMBER 2022**  
**SWISS FRANCS (CHF)**

	EXPENSES			REVENUE	
	Budget 2022	Expenses 2022		Budget 2022	Revenue 2022
<b>1A. Administration</b>	<b>3 063 000</b>	<b>2 736 389</b>	<b>5. Donations</b>	<b>5 000 000</b>	<b>-</b>
1.1 Payroll expenses	1 480 000	1 216 283	5.1 Donations	5 000 000	-
1.2 Operating expenses(fees, insurance, translations, rent, IT, etc)	455 000	455 170			
1.3 Congresses (total paid by the FIE)		-			
1.3a Organisation (venues, security, covid measures, translation, medals, gifts, etc)	300 000	227 865			
1.3b Participation of the President of each NF, air tickets, rooms, transport, meals, etc.		188 605			
1.4 Bureau and Executive Committee	190 000	194 790	<b>6. Federations</b>	<b>309 000</b>	<b>349 863</b>
1.5 Executive Committee and staff travel to WCH		-	6.1 Federation annual fees	57 000	55 130
1.5.a flights, rooms and visas WCH Juniors-Cadets		62 489	6.2 Organisation fees	-	33 328
1.5.b Per diem WCH Juniors-Cadets	100 000	12 358	6.3 International licences	200 000	169 457
1.5.c Fights, rooms and visas WCH seniors		22 270	6.4 Referee examination fees	12 000	9 771
1.5.b Per diem WCH Seniors		6 453	6.4 Other revenue	40 000	82 176
1.6 Commissions and Councils (specific meetings)	240 000	78 849			
1.7 Anti-doping	260 000	158 292			
<b>1B. Finance and provisions</b>	<b>38 000</b>	<b>112 965</b>			
1.8 Amortisation	8 000	14 748			
1.9 Financial bank charges (bank transfer charges and management fees)	25 000	97 724			
1.10 Provisions/Losses on receivables	5 000	494			
<b>1.C Provision for holidays and overtime</b>		<b>28 297</b>			
<b>2. Sport</b>	<b>3 303 000</b>	<b>2 520 292</b>	<b>7. Finance and provisions</b>	<b>50 000</b>	<b>475 557</b>
2.1 Subsidies to confederations	240 000	240 000	7.1 Financial income	50 000	46 887
2.2 Equipment for federations	600 000	594 971	7.2 Net foreign exchange gain (revaluation)	-	210 322
2.3 Schools, training for Fencing masters	810 000	519 423	7.3 Income from previous years	-	218 348
2.4 Championship training camps	100 000	120 901			
2.5 Referecing - bonuses	440 000	194 594			
2.6 Aid to federations	480 000	465 958			
2.7 J/C World Championships	100 000	108 229	<b>8. IOC</b>	<b>67 200</b>	<b>66 570</b>
2.8 Seniors/Veterans World Championships	123 000	87 767	8.1 IOC development aid subsidy	67 200	66 570
2.9 World Cups, GP, ZCH	75 000	41 917			
2.10 Service providers	75 000	59 356			
2.11 Athlete career programme	50 000	-	<b>9. Revenues from the Olympic Games</b>	<b>-</b>	<b>-</b>
2.12 Confederation sports directors	120 000	72 000			
2.13 Projects	90 000	15 176			
<b>3. Com/Mkt/TV</b>	<b>2 792 000</b>	<b>1 223 272</b>	<b>10. Com/Mkt/TV</b>	<b>80 000</b>	<b>92 000</b>
3.1 Video portal / Digital content / Website	350 000	141 645	10.1 Escrime magazine	55 000	26 944
3.2 Magazines	150 000	46 788	10.2 Sponsorship	-	-
3.3 Communication	70 000	55 690	10.3 Television rights	25 000	65 056
3.4 Marketing	80 000	79 545			
3.5 Events	480 000	181 987			
3.6 Service providers	141 000	153 221	<b>11. Other revenue (reserve)</b>	<b>5 192 800</b>	<b>-</b>
3.7 TV Broadcast (Eurosport)	1 521 000	564 395			
<b>4. FIE 2021-2022 support for organisers</b>	<b>1 541 000</b>	<b>1 221 737</b>			
<b>4. Bis Previous years' expenses (invoices received after the accounts have been closed)</b>		<b>11 552</b>			
<b>SUB-TOTAL</b>	<b>10 699 000</b>	<b>7 741 541</b>		<b>10 699 000</b>	<b>983 990</b>
<b>12. Income surplus</b>			<b>13. Expenses surplus</b>		<b>6 757 551</b>
<b>TOTAL</b>	<b>10 699 000</b>	<b>7 741 541</b>	<b>TOTAL</b>	<b>10 699 000</b>	<b>7 741 541</b>



2024 BUDGET - SWISS FRANCS (CHF)					
	EXPENSES			REVENUES	
	Jan/Dec 2023	Jan/Dec 2024		Jan/Dec 2023	Jan/Dec 2024
	Budget	Budget		Budget	Budget
<b>1. ADMINISTRATION AND FINANCES</b>	<b>2 355 000</b>	<b>2 355 000</b>	<b>6. Donations</b>	-	-
1.1. Personnel costs	1 190 000	1 190 000			
1.2. Operating costs	425 000	425 000			
1.3. Organisation of the Congress/subsidy flights Presidents NFs	220 000	240 000	<b>7. Federations</b>	<b>399 100</b>	<b>356 100</b>
1.4. Bureau and Executive Committee (on site and online meetings)	100 000	100 000	7.1. Federations annual fee	55 000	55 000
1.5 Displacements of the Executive Committee and staff to World Championships	100 000	60 000	7.2. Organising fees	92 100	92 100
1.6. Commissions and Councils	70 000	40 000	7.3. International licences	200 000	160 000
1.7. Anti-doping	200 000	250 000	7.4. Refereeing exam fees	12 000	9 000
1.8. Exchange losses	-	-	7.5. Other revenues	40 000	40 000
1.9 Financial costs	25 000	25 000			
1.10 Amortization	20 000	20 000			
1.11 Provisions/losses	5 000	5 000			
<b>2. SPORT</b>	<b>2 658 000</b>	<b>2 400 000</b>	<b>8. Finances</b>	<b>50 000</b>	<b>50 000</b>
2.1. Confederation subsidies	240 000	240 000	8.1. Interests	50 000	50 000
2.2. Material for federations	600 000	600 000	8.2. Exchange gain realised	-	-
2.3. Schools, training	600 000	400 000	8.3. Adjustements in currency values		
2.4. Training camp at J/C World Championships	100 000	60 000	8.4. Previous years' revenue		
2.5. Refereeing - exams, seminars, primes	240 000	240 000	8.5. Dissolution of provision		
2.6. Aid for federations	480 000	480 000			
2.7. Junior/Cadet World Championships	100 000	100 000			
2.8. Senior/Veteran World Championships	123 000	30 000	<b>9. IOC</b>	<b>67 200</b>	<b>15 067 200</b>
2.9. Grand Prix, World Cups, Zonal Champs, Zonal qualifying events	75 000	150 000	9.1. Subsidy for development programme	67 200	67 200
2.10. Service providers	100 000	100 000	9.2. Revenue of the 2024 Olympic Games	-	15 000 000
<b>3. Com/Mkt/TV</b>	<b>1 685 000</b>	<b>1 375 000</b>	<b>10. Paris 2024</b>	<b>-</b>	<b>80 000</b>
3.1. Digital content/video/website	350 000	200 000	10.1 Subsidy for ITOs costs		80 000
3.2. Publications	120 000	80 000			
3.3. Communication	85 000	85 000			
3.4. Marketing	80 000	80 000	<b>11. Com/Mkt/TV</b>	<b>80 000</b>	<b>50 000</b>
3.5. Events (live streaming/commentary/photography)	300 000	180 000	11.1 Magazine	55 000	25 000
3.6. Service providers	200 000	200 000	11.2 Sponsoring	-	-
3.7. Broadcast	550 000	550 000	11.3 Television rights	25 000	25 000
<b>Sub-total</b>	<b>6 698 000</b>	<b>6 130 000</b>			
<b>4. Olympic Games 2024</b>	<b>-</b>	<b>420 000</b>	<b>12. Other financial resources (reserve)</b>	<b>6 833 700</b>	
4.1. Rooms (final payments)		90 000			
4.2. Displacements of the Executive Committee and staff		80 000			
4.3. ITOs (flights, per diem, transportation, etc.)		180 000			
4.4. Promotion (videos, website, communications, promotional tools, etc.)		70 000			
<b>5. FIE support plan (Swiss Timing in season 2023-2024 for GPs)</b>	<b>732 000</b>	<b>400 000</b>			
<b>TOTAL EXPENSES</b>	<b>7 430 000</b>	<b>6 950 000</b>	<b>TOTAL INCOME</b>	<b>7 430 000</b>	<b>15 603 300</b>
<b>Excess of revenue over expenses</b>		<b>8 653 300</b>			
<b>GENERAL TOTAL</b>	<b>7 430 000</b>	<b>15 603 300</b>	<b>TOTAL INCOME</b>	<b>7 430 000</b>	<b>15 603 300</b>



**BID QUESTIONNAIRE**

**FOR ORGANISATION**

**OF THE JUNIOR AND CADET**

**FENCING WORLD CHAMPIONSHIPS**

## IMPORTANT INFORMATION FOR BIDDING FEDERATIONS

- ❖ The FIE assigns the organisation of the World Championships to the National Federation of the host city. This federation will create a World Championships Organising Committee, which, coordinating at all times with the National Federation, will, from its inception, communicate directly with the FIE, from whom it receives its instructions.
- ❖ FIE World Championships and other official FIE events are only assigned to National Member Federations who ensure free access to competitors and officials and whose Organizing Committees commit to send invitations to all the Federations having the right to take part, and who do everything in their power to obtain the visas needed.
- ❖ The Organising Committee must comply with all the FIE Rules, Statutes, Administrative Rules and the Handbook of Regulations of the FIE from its inception up until its dissolution. The member Federation which applies as a candidate to organise congresses, official competitions, or any other FIE international events will document that the organizer will use all means to enable all the member Federations to take part in those events, without any discrimination whatever.
- ❖ The FIE retains the right of final say on all questions pertaining to the World Championships.
- ❖ The bid must be sent by the national federation and reach the FIE Head Office **three (3) years before** the date of organization of the World Championships, before the Congress. On this occasion the candidates will be announced.
- ❖ The complete file of candidature must reach the FIE Head Office before the 1<sup>st</sup> of September.
- ❖ The candidate federation will have to make a commitment, in front of the Congress, to respect the FIE Handbooks of regulations and its financial obligations. A signed protocol between the FIE and the organizing federation will state its perfect knowledge of its obligation
- ❖ The bid procedure has to take place according to the FIE statutes
- ❖ The Organising Federation must provide a written agreement from the Ministry of Foreign Affairs guaranteeing the granting of visas to all the participants of the member national federations of the FIE.
- ❖ As specified on the relevant articles of the questionnaire it is obligatory to present plans and dimensions of all the competition venues attached to this document.

**Do you herewith accept the presented FIE bidding rules, procedure and specified special requirements?**                      YES                       NO

## QUESTIONNAIRE

### 1. Name of the Bidding Federation

Chinese Fencing Association

---

---

### 2. Bidding Event (tick the corresponding square)

- Junior and Cadet World Championship

### 3. Place and dates of the event

Place City / Town: Wuxi city, Jiangsu province, China

Dates: From 1<sup>st</sup> Apr. To 15<sup>th</sup> Apr. Year 2025

### 4. Presentation of the City/Town

- Present map with marked position of competition venues, hotels, airport, train station etc.

#### MAP



- City/Town details (Population, surface, climate, height etc.)  
Population: about 7.5 million  
Surface: belongs to the plain area  
Climate: four distinct seasons and mild climate

---

- Present the major fencing competitions or other sports tournaments already organized in this city/town  
1.Asian & Oceanic Olympic Qualifiers  
2.2016 Asian Fencing Championships  
3.2018 World Fencing Championship  
4.2022 National Fencing Championship  
5.2023 Asian Fencing Championship

---

**5. Composition of the Organising Committee****5.1 Organizing Committee Management**

Title	Surname	Name	Contact Details
President	Wang	Haibin	wanghaibin.fe@sports.cn
Vice President			
Secretary General	Wang	Junyan	wangjunyan.fe@sports.cn
Treasurer			

**5.2 Organising Committee Important Portfolios**

To be confirmed.

Portfolio	Surname	Name	Contact Details
Administration			
Invitation of Participants			
Invitation of Officials			
Immigration and Visas			
Entries and Accreditations			
Technical Organization			
Venue Renting			
Telecommunications			
IT Support			
Safety and Security			
Accommodation			
Catering and Refreshments			
Transportation			
Technical Support			
Maintenance			
Publicity and Promotion			
Press and Media Relations			
Relations with Officials			
Call Room Services			
Equipment Control			
Medical Service			
Protocol			
Sound System			

**6. Organising Committee Contact Details**Physical Address: Luo She Zhen Mei Jing Cun, Huishan District, Wuxi City, Jiangsu Province, ChinaPostal address: 6F Absolute Fencing Center, 618 Zhongshan Road, Liangxi District, Wuxi City, Jiangsu Province, ChinaTel.: +864001088858

Fax: \_\_\_\_\_

E-mail: affencing@wuxiweiteng.comUrl: http://www.affencing.com/Mobile Phone: +8617315510261

## 7. Financing

The following is detailed Budget of the event, with specified sources of the Income and estimated Expenditures:

### 7.1 Income

Description	Amount (Currency)
Public Subventions	
• National	¥1000000
• Regional	¥1000000
• Local	¥5000000
• Others	¥200000
Business Sponsors and Partners	¥1000000
Private Sponsors and Donors	¥250000
Official providers	¥800000
Miscellaneous Sales	
• Tickets	¥0
• Rent of Stands	¥60000
• By-products	¥50000
• Catering and Refreshments	¥30000
• TV Rights	¥0
Other	¥0
<b>Total</b>	<b>¥9390000</b>

### 7.2 Expenditures

Description	Amount (Currency)
• Accommodation	¥800000
• Accreditation	¥50000
• Administrators	¥100000
• Air conditioning	¥120000
• Anti-doping service	¥60000
• Ceremonies and receptions	¥500000
• Cleaning	¥100000
• Computers, telephone, fax	¥50000
• Decoration	¥600000
• Electricity and water	¥100000
• Equipment	¥200000
• FIE guests, officials and VIP	¥100000
• Hostesses, Interpreters, Drivers etc....	¥150000
• Information/Public relations/Promotion:	¥300000
• Insurance	¥20000
• Medical service	¥100000
• Organising Committee	¥500000

• Officials	¥100000
• Other Expenses	¥200000
• Pistes and equipment specific to fencing	¥1150000
• Promotion and Publicity	¥500000
• Referees	¥350000
• Results system	¥200000
• Security	¥250000
• Settings	¥60000
• Sound system, lights	¥500000
• Technicians	¥100000
• Transportation	¥600000
• Venues	¥1000000
• Volunteers	¥360000
• Wireless	
<b>Total</b>	<b>¥9220000</b>

**8. Official Support Documents from the National and/or Local Authorities**

Can you provide Official Support Documents from the National and/or Local Authorities (including visa guarantee letter)? YES  NO

If YES, these documents are to be listed and attached to this document.

Authority	Document
Jiangsu Sports Bureau	

**9. Event Program**

Detailed Program of the event will be submitted to the FIE Executive committee for approval.

Typical program of the Junior and Cadet World Championship is as follows:

DAY 1 - Friday		
Junior Women's Sabre	Pools - DE 64 - Final	HALLS _____
Junior Men's Sabre	Pools - DE 64 - Final	HALLS _____
DAY 2 - Saturday		
Cadet Women's Sabre	Pools - DE 64 - Final	HALLS _____
Cadet Men's Sabre	Pools - DE 64 - Final	HALLS _____
DAY 3 - Sunday		
Junior Women's Sabre Team	DE 64 - Final	HALLS _____
Junior Men's Sabre Team	DE 64 - Final	HALLS _____
DAY 4 - Monday		
Junior Women's Foil	Pools - DE 64 - Final	HALLS _____
Junior Men's Foil	Pools - DE 64 - Final	HALLS _____

<b>Opening Ceremony</b>		HALLS _____
<b>DAY 5 - Tuesday</b>		
Cadet Women's Foil	Pools - DE 64 - Final	HALLS _____
Cadet Men's Foil	Pools - DE 64 - Final	HALLS _____
<b>DAY 6 – Wednesday</b>		
Junior Women's Foil Team	DE 64 - Final	HALLS _____
Junior Men's Foil Team	DE 64 - Final	HALLS _____
<b>DAY 7 – Thursday</b>		
Junior Women's Epee	Pools - DE 64 - Final	HALLS _____
Junior Men's Epee	Pools - DE 64 - Final	HALLS _____
<b>DAY 8 – Friday</b>		
Cadet Women's Epee	Pools - DE 64 - Final	HALLS _____
Cadet Men's Epee	Pools - DE 64 - Final	HALLS _____
<b>DAY 9 - Saturday</b>		
Junior Women's Epee Team	DE 64 - Final	HALLS _____
Junior Men's Epee Team	DE 64 - Final	HALLS _____
<b>Closing Ceremony</b>		HALL _____

**Do you herewith confirm that you will implement the presented Typical Program of the Junior and Cadet World Championship?**

YES  NO

#### **10. Venue for the Competition**

Name of the Venue: Wuxi Taihu International Expo Center

Address of the Venue: No.88,Qingshu Road,Binhu District,Wuxi,Jiangsu province,China

Number of the Available Halls: 6

Number of Halls to be Used: 6

#### **10.1 Allocation of the Selected Halls:**

##### **10.1.1 Preliminary Phase Halls**

- Number of Preliminary Phase Halls: 2
- Dimensions of each Hall: 110m\*65m
- Number of Pistes at each Hall: 20
- Total Number of Pistes: 40
- Average Width of the Refereeing Zone: 4m

#### **DRAWINGS OF THE PRELIMINARY PHASE HALLS**





**10.1.2 Hall for the Direct Elimination**

- Dimensions of the Hall: 110m\*65m
- Four (4) Coloured Pistes in different colours YES  NO
- Wireless System (optional) YES  NO
- Location for the Video-Refereeing Camera on the same side as the referee, outside of Refereeing zone YES  NO
- Video Refereeing Station on the same side as the referee, outside of refereeing zone YES  NO

**DRAWING OF THE HALL FOR DIRECT ELIMINATION**

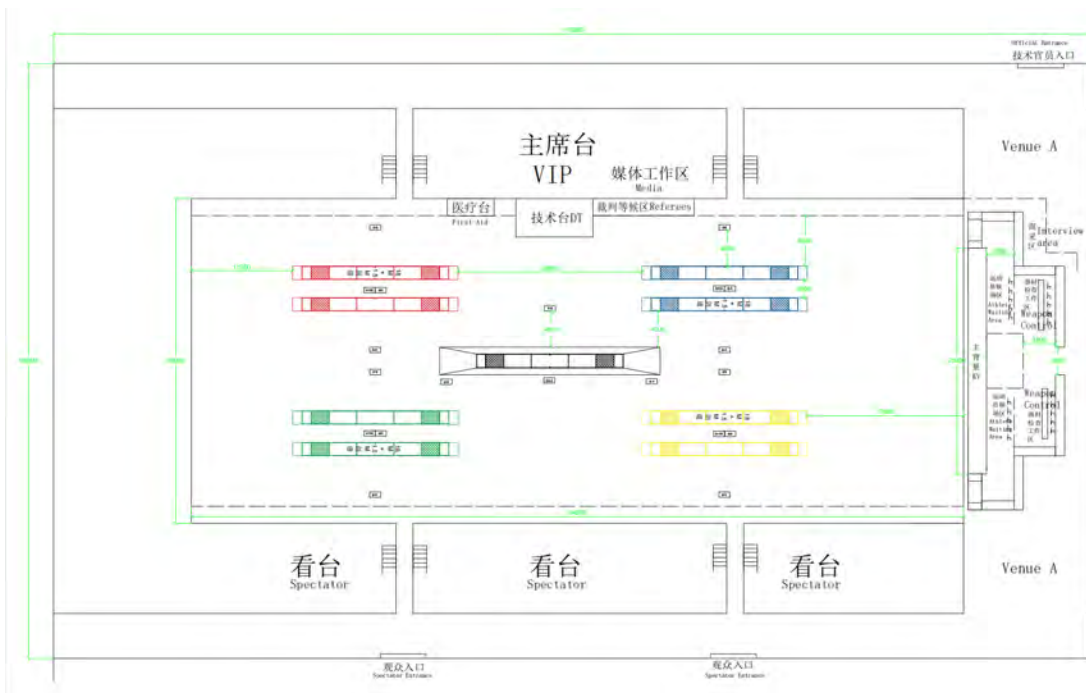

**10.1.3 Hall for the Finals – Single Piste**

- YES  NO

- Blue carpet on the entire square four (4) Coloured Pistes around podium (Final piste)  
**YES**       **NO**
- Dimensions of the Hall: 84m\*36m
- One (1) Piste 1.5m to 2m wide, 18m Lng      **YES**       **NO**
- Piste on the podium 30 – 50cm raised, with lateral safety minimum 25cm and inclines at the end of the piste      **YES**       **NO**
- Refereeing zone 4.0 – 4.5m from the piste      **YES**       **NO**
- Wireless System (optional)      **YES**       **NO**
- Location for the Video-Refereeing Camera on the same side as the referee, outside of Refereeing zone      **YES**       **NO**
- Video Refereeing Station on the same side as the referee, outside of Refereeing zone (4.0m minimum)      **YES**       **NO**
- Wireless Microphone for the Referees      **YES**       **NO**

**DRAWING OF THE HALL FOR FINALS**

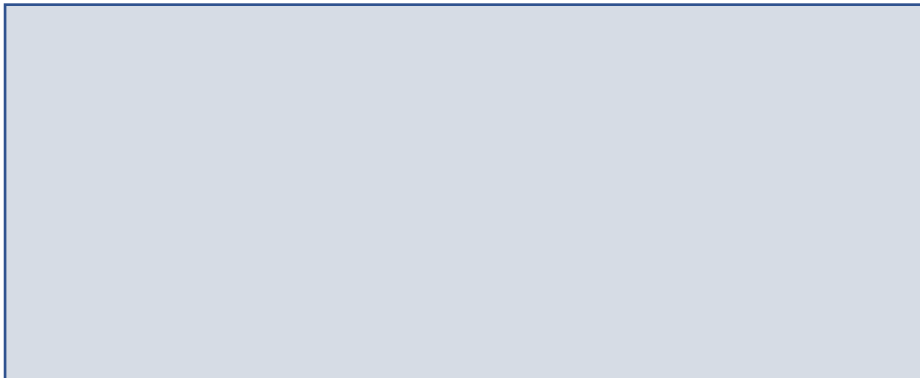

**10.1.4 Hall for the Direct Elimination and Finals with Single Piste and four (4) Coloured Pistes.**

- YES**       **NO**
- Blue carpet on the entire square four (4) Coloured Pistes and around podium (Final piste)  
**YES**       **NO**
  - Dimensions of the Hall: 84m\*36m
  - Four (4) Coloured Pistes in different colours      **YES**       **NO**
  - Wireless System (optional)      **YES**       **NO**
  - Location for the Video-Refereeing Camera on the same side as the referee, outside of Refereeing zone      **YES**       **NO**
  - Video Refereeing Station on the same side as the referee, outside of Refereeing zone      **YES**       **NO**
  - One (1) Final Piste 1.5m to 2m wide, 18m Long      **YES**       **NO**
  - Piste on the podium 30 – 50cm raised, with lateral safety minimum 25cm and inclines at the end of the piste      **YES**       **NO**
  - Refereeing zone 4.0 – 4.5m from the piste      **YES**       **NO**
  - Wireless System (optional)      **YES**       **NO**
  - Location for the Video-Refereeing Camera on the same side as the referee, outside of Refereeing zone      **YES**       **NO**

- Video Refereeing Station on the same side as the referee, outside of Refereeing zone (4.0 m minimum) **YES**  **NO**
- Wireless Microphone for the Referees **YES**  **NO**

**DRAWINGS OF THE HALL FOR DIRECT ELIMINATION AND FINALS**

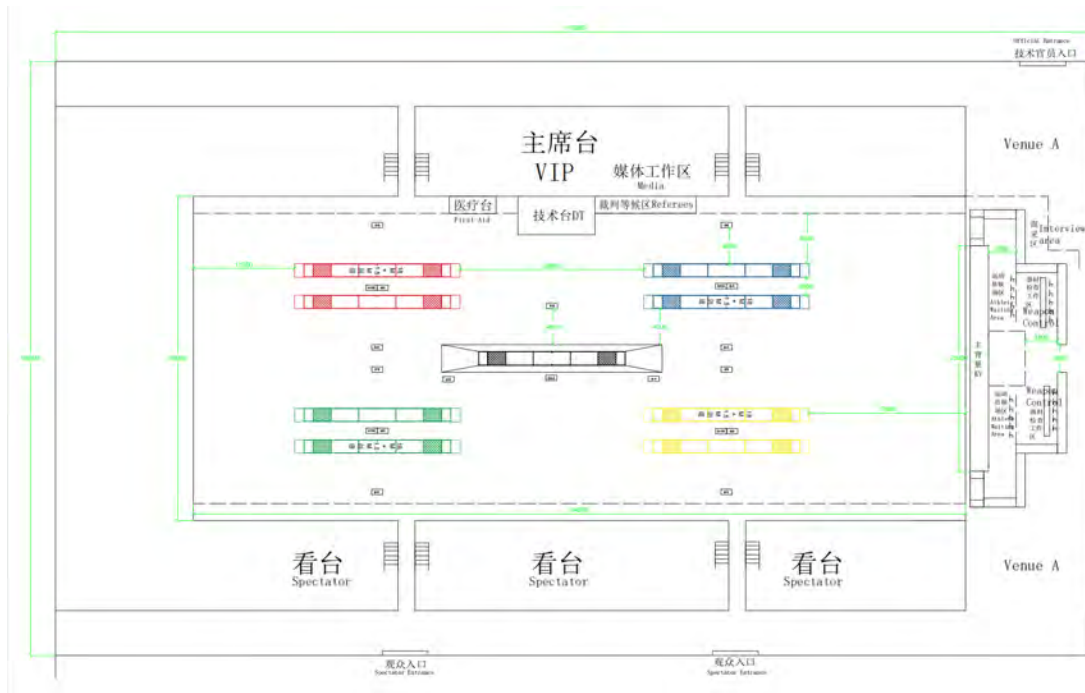

**10.1.5 Training Halls** **YES**  **NO**

- Number of Training Halls: 1
- Dimensions of the Halls: 110m\*65m
- Total Number of Pistes: 20
- Total Number of Team boxes 130
- Team box dimensions (for National team) 3mx4m

**10.1.6 Warm-up Halls** **YES**  **NO**

- Number of Warm-up Halls: 1

**10.2 Capacity of Spectators per Each Hall**

Preliminary Phase Halls: 1000  
 Hall for the Direct Elimination: 2000  
 Hall for the Finals: 2000

**10.3 Rest rooms for the Athletes** **YES**  **NO**

- Number of Rest Rooms for Athletes: 2
- Dimensions of Rest Rooms: 15m\*10m

#### 10.4 Rooms for Control of Weapons and Equipment

- Size of the selected room 400 m<sup>2</sup> (Minimum 150m<sup>2</sup>-)
- Room must be operational and open 72 hours before the beginning of the first event. Is that realisable? **YES**  **NO**

#### 10.5 Office of Directoire Technique

- Size of the selected room 200 m<sup>2</sup> (Recommended 150-200m<sup>2</sup>-)
- Internet access and ADSL/Fiber Optic Line **YES**  **NO**
- Six (6) Tables of 2m length **YES**  **NO**
- Two (2) Computers for administration **YES**  **NO**
- Two (2) Computers with Printers **YES**  **NO**
- Reserve set of equipment (computers, printers, cartridges etc.) **YES**  **NO**
- One (1) High-performance Photocopier **YES**  **NO**
- Telephone Line and Telephone **YES**  **NO**
- Two (2) Wireless Microphones **YES**  **NO**
- Notice Board **YES**  **NO**

#### 10.6 Other rooms and halls (tick the existing)

- FIE Offices Size: 60 m<sup>2</sup>
- President's office Size: 60 m<sup>2</sup>
- Secretary General/Treasurer's office Size: 60 m<sup>2</sup>
- FIE Meetings Room Size: 80 m<sup>2</sup>
- OC Room Size: 80 m<sup>2</sup>
- Referees Room (min 150m<sup>2</sup>) Size: 300 m<sup>2</sup>
- Doping Control Station Size: 100 m<sup>2</sup>
- Accreditation Room (min 100m<sup>2</sup>) Size: 100 m<sup>2</sup>
- Information Centre Size: 100 m<sup>2</sup>
- Press Centre (equipped) Size: 120 m<sup>2</sup>
- Conference Room Size: 300 m<sup>2</sup>
- FIE Stands (DYFG, Clean sport, Safe sport, others) Size: 300 m<sup>2</sup>
- Fencing equipment suppliers Size: 100 m<sup>2</sup>
- Other Size: \_\_\_\_\_

#### 10.7 Specification and Description of the Equipment available in Each Room

FIE Offices : 6 Tables of 2m length, Several chairs, wireless Internet

OC Room : 6 Tables of 2m length, Several chairs, wireless Internet

Referees Room : 20 Tables of 2m length, Several chairs, wireless Internet

Doping Control Station : 6 Tables of 2m length, Several chairs, one fridge, Male and female restrooms

Press Centre : 10 Tables of 2m length, Several chairs, wireless Internet

FIE Stands : 2 Tables of 2m length, Several chairs, wireless Internet

Fencing equipment suppliers : 6 Tables of 2m length, Several chairs, wireless Internet

**10.8 Catering Facilities at the Venue**

- Number of Restaurants 1
- Number of Snacks (Sandwiches and fast Food Service) \_\_\_\_\_
- Number of Drinks Sale Services 1
- Number of Tuck Shops \_\_\_\_\_

**10.9 Food and Refreshment Prices (Attach Price Lists)**

Fast food: about 40 RMB

Buffet in the hotel: about 120 RMB

Coffee: about 25-50 RMB

Fruit juice: about 20-30RMB

Bottled water: about 10-20RMB

**10.10 Staff in the Venue**

- Professionals  Number: 20
- Volunteers  Number: 100

**11. Material and Equipment**

a) Name of the supplier of fencing material and equipment for Weapon Control:  
Aboslute Fencing

---

b) List of equipment for weapon control:

1. gauges
2. weights (500g and 750g)
3. scales
4. electrical measuring machines
5. device allowing the lighting stroke and residual travel
6. labels
7. foucault current device
8. special stamp
9. special ink and paint

c) Name of the supplier of fencing material and equipment: for fencing halls  
Aboslute Fencing

---

d) Name of apparatus and reels (supplier/model):  
Aboslute Fencing

---

---

e) Name of supplier of fencing pistes:  
Aboslute Fencing

---

f) Name of software for the management of the competitions:  
FencingTime

g) Name of the person in charge of computers in the OC:  
David Blake

h) Number of computers for the management of the competitions:  
4

i) Name of the person in charge of computers in the OC:  
To be confirmed

## **12. Accommodation and Transportation**

### **12.1 Available International Travel Options**

- Airplane  Name of the Airport Wuxi Shuofang International Airport, Southern Jiangsu
  - Train  Name of the Station Wuxi railway station and Wuxi East Railway Station
- Other  Details: If you arrive at shanghai, you can take train to wuxi. If you arrive at other country, you can transfer to Wuxi Shuofang International Airport, Southern Jiangsu.

### **12.2 Category, Number and Prices of the Officially Selected Hotels**

<b>Venue</b>	<b>Number of Hotels</b>	<b>Price P/P Single Room</b>	<b>Price P/P Double Room</b>	<b>Price P/P Breakfast</b>
Worldhotel Grand Juna Wuxi	370	¥1200	¥1200	¥128 (including 2 breakfast)
HOLIDAY INN WUXI TAIHU NEW CITY	226	¥800	¥800	¥68 (including 2 breakfast)
HOLIDAY INN EXPRESS WUXI TAIHU NEW CITY	158	¥600	¥600	¥38 (including 2 breakfast)
HUALUXE Wuxi Taihu Hotel	302	¥1200	¥1200	¥138 (including 2 breakfast)
Pullman Wuxi New Lake	404	¥1000	¥1000	¥128 (including 2 breakfast)

Other Accommodations.				
-----------------------	--	--	--	--

### 12.3 Distance between the Airport / Railway Station and Hotels

Venue	Distance (km)	Timing (hrs)
Worldhotel Grand Juna Wuxi	15-16	0.3-0.5
HOLIDAY INN WUXI TAIHU NEW CITY	12-13	0.25
HOLIDAY INN EXPRESS WUXI TAIHU NEW CITY	12-13	0.25
HUALUXE Wuxi Taihu Hotel	14-15	0.3-0.5
Pullman Wuxi New Lake	11-17	0.3-0.5
Other Accommodations.		

### 12.4 Distance between Hotels and Competition Venue

Venue	Distance (km)	Timing (hrs)
Worldhotel Grand Juna Wuxi	0.9	5-6 minutes walk
HOLIDAY INN WUXI TAIHU NEW CITY	1	5-6 minutes walk
HOLIDAY INN EXPRESS WUXI TAIHU NEW CITY	1	5-6 minutes walk
HUALUXE Wuxi Taihu Hotel	2.9	5-6 minutes by car
Pullman Wuxi New Lake	5.2	8-10 minutes by car
Other Accommodations.		

### 12.5 Arrangement for Transportation of Delegations

Transport Description	Bus	Mini-Bus	Shuttle	Other	Price
From Airport/ Station to Hotels	√				¥300/person
From Hotels to Competition Venues			√		¥100/person
From Hotels to Training Venues			√		¥100/person

**12.6 Arrangement for Transportation of Officials**

Transport Description	Bus	Mini-Bus	Shuttle	Other	Price
From Airport/ Station to Hotels	√	√	√	√	free of charge
From Hotels to Competition Venues	√	√	√	√	free of charge

**13. Publicity and Promotion**

What publicity and promotion methods you plan to use:

- Advertisements on Radio
- Advertisements on TV
- Press conferences
- Street Posters and Bans
- Dedicated website/social media
- Other

Present details of the publicity and promotion plan:

In the scope of publicity, from the two levels of the province at the same time, the early stage of the city-based media, the game to focus on the media outside the city.

In the propaganda period, it is divided into three stages: pre-stage, mid-stage and post-stage, each with different emphasis.

Mobilize all kinds of media in and out of the city on the propaganda team.

In the content of the publicity, the city's overall image publicity and the special combination of the event, the organization of reporters to track the entire event report.

In the means of propaganda, sensory media (i.e. broadcast and television media), print media, Internet media, outdoor advertising, news release, event promotion and other methods combined to use new media-based. At the same time, it creates news suspense and commercial hype, and sets up columns and separate pages in important media to produce special topics such as event publicity reports, sports rules, athlete analysis, etc. .

**14. Tickets and Derived Products**

- How many tickets you expect to sell during the WC? 1000 per day
- What price of tickets you will apply? Free

**15. Press Coverage**

Press coverage of the World Championship must be in line with the FIE Press Handbook.



**Do you herewith confirm that you are committed to implement the FIE Press Handbook?** YES  NO

**16. Television Coverage**

TV coverage of the World Championship must be in line with the FIE Television Handbook.

**Do you herewith confirm that you are committed to implement the FIE Television Handbook?** YES  NO

**16.1 Details of the Television Coverage Plan**

- National TV Channels
  - Live Broadcast  Number of Hours: 1
  - Recorded Broadcast  Number of Hours: 18
- Regional TV Channels
  - Live Broadcast  Number of Hours: 18
  - Recorded Broadcast  Number of Hours: 55
  - Other

Present details of the TV Coverage plan:

Interactive Q & A in the studio

Live interview.

Interactive discussion.

ExpertForum.

**17. Marketing plan**

**17.1 Details of the Marketing Plan**

Recruitment of volunteers

Face-to-face exchanges between college coaches

Face-to-face exchanges between Olympic and world fencing champions

**17.2 Date when the complete Marketing Plan will be submitted to the FIE**

7-10 days

**18. Sponsors**

**18.1 Sponsors Selection**

Organising Committee cannot approach or make sponsorship arrangements with any company that is competitor with the major FIE sponsors.

**Do you herewith confirm that you will comply with presented criteria for selection of the sponsors?** YES  NO

**Do you herewith confirm that you are committed to implement Requirements that are specified in the FIE Press Handbook and the FIE Handbook of Regulations for WC?** YES  NO

**18.2 Date when the complete List of Sponsors will be submitted to the FIE**

1month before the match

## 19. Protocol

The protocol ceremonies must be organised as specified in the FIE Handbook of Regulations for the Organization of Protocol Ceremonies at FIE Competitions.

The FIE Chief of Protocol coordinates with the LOC Protocol Manager to ensure that all elements of FIE protocol are respected.

**Do you herewith confirm that Protocol will be organised according to this FIE document?** YES

NO

## 20. Medical Service

Medical Service is to be provided in accordance for by the FIE Rules, the FIE Administrative Rules, the FIE Handbooks of Regulations and FIE Medical Handbook.

**Do you herewith confirm that you will comply organization of the Medical Service with the listed FIE Documents?** YES  NO

Medical Service is covering Medical Emergencies, Sports Trauma, General Medical Care and Additional Medical Services (Physiotherapy etc.).

Basic requirements are as follows

- Medical Stations, with locally licenced paramedic or doctor, must be present in competition halls, **MAXIMUM two (2) minutes away from the furthest hall**, and properly marked;
- Adequate ambulance must be present on site or **MAXIMUM at ten (10) minutes' drive distance**;
- Hospital with the emergency ward and facilities required for treatment of the possible injuries and illnesses must be selected and arrangements made for adequate support in case of emergency;

**Do you herewith confirm that you will meet Medical Service requirements?**

YES  NO

## 21. Doping Control

According to the FIE Anti-Doping Rules, Doping Control tests are obligatory at all World Championships.

Testing process must be strictly managed according to the WADA regulations.

Doping Control Office (DCO) must be supplied by the National Anti-Doping Organization (NADO).

Analysis of the samples must be performed by the IOC accredited laboratory. Coordinator of the doping control is the FIE Medical Delegate.

Doping Control station must be allocated as close as possible to the Finals venue, with all required facilities to accommodate limited access, privacy, preparation of the documentation, taking and processing samples.

Sample collection bottles, containers and forms are to be supplied the NADO.

**Do you herewith confirm that you will meet Doping Control requirements according to these regulations?** YES  NO

**22. Security**

The Organizing Committee has to organise Security and Safety Service in order to provide:

- The health and physical security of all the participants;
- Safety of all the installed equipment;
- Regulation of access to various sites of the competition in line with the applied accreditation;
- No unauthorised access of the pistes and official rooms by the public;
- Good and safe circulation of people;

Also, discreet police service and the presence of a fire service is to be planned.

**Do you herewith confirm that you will meet presented Security requirements?**

**YES**       **NO**

**23. Insurance**

The Organising Committee must, at its own costs, institute:

- Liability Insurance policy which will include general liability coverage, as well as a guarantee for non-consecutive intangible damages (pure financial loss).
- All other mandatory insurance, such as:
  - ❖ Fire and fire damage insurance policies for premises necessary to the organisation
  - ❖ Automobile insurance policies (if necessary)
  - ❖ All policies mandated by local legislation.
- Repatriation Assistance coverage for the Fencing family, but without covering the designated officials or referees, the Executive Committee, or FIE personnel.

**Do you herewith confirm that you will meet presented Insurance requirements?**

**YES**       **NO**

**24. Rewards for the Winners**

**YES**       **NO**

Present details of the planned Rewards for the Winners:  
MEDALS and certificates

---

**25. Cultural Programme Plan**

**YES**       **NO**

Present details of the Cultural Plan:  
professional promotion team is in charge

---

**26. Environmental Protection Plan**

**YES**       **NO**

Present details of the Environmental Protection Plan:  
In accordance with international environmental requirements.

---



# 中国击剑协会

## Chinese Fencing Association

---

### Letter of commitment

(On letterhead of the NF)

Letter of Commitment

The national federation of China

hereby bidding to the organisation of the 2025 Junior& Cadet World Championships

- 1) Hereby confirms that it has full knowledge of all its obligations and financial obligations to organise an FIE 2025 Junior&Cadet World Championships.
- 2) Hereby confirms that it is committed:
  - a) to respect and implement the FIE Statutes, including articles 1.2.4 and 1.2.5, the FIE Ethics and Safeguarding codes, the FIE rules, the FIE Administrative Rules, the FIE handbook of regulations, FIE Protocol handbook and any FIE rule in force.
  - b) to respect Its financial obligations
- 3) confirms that it has received from its national authorities a written agreement guaranteeing the granting of visas to all the participants of the member national federations of the FIE.

13th Sept., Beijing China

  
Chinese Fencing Association  

Official Support Document from the Local Authorities:

Jiangsu Provincial Sports Bureau on the approval of Wuxi City bid for the 2025 Junior and Cadet World Championships

# 江苏省体育局

## 江苏省体育局关于商请同意无锡市申办 世界青少年击剑锦标赛的函

中国击剑协会：

我省无锡市申请承办2025或2026年世界青少年击剑锦标赛。经研究，我局认为无锡市满足办赛条件，具备良好的接待能力和办赛经验，并能够承担赛事所需经费，故商请贵协会同意无锡市承办此项赛事。

特致此函，请予批准。

附件：无锡市体育局关于报请省体育局同意申办世界青少年击剑锦标赛的请示



(联系人：赵迪，电话：025-51889596, 18020140925)

Translation

## Official Support Document from the Local Authorities:

Jiangsu Province Sports Bureau on the approval of Wuxi City bid for the 2025 Junior and Cadet World Championships

Chinese Fencing Association:

Wuxi City of our province applies to host the 2025 or 2026 World Junior and Cadet World Championships. After research, we believe that Wuxi City can meet the requirement of hosting the event. The local organizing committee has plenty of international experience and can bear the cost of the event. Therefore, we would like to ask you to agree that Wuxi bid for World Junior and Cadet World Championships.

I am writing to you for your approval.

Jiangsu Province Sports Bureau

September 7, 2023



**BID QUESTIONNAIRE**

**FOR ORGANISATION**

**OF THE JUNIOR AND CADET**

**FENCING WORLD CHAMPIONSHIPS**

## **IMPORTANT INFORMATION FOR BIDDING FEDERATIONS**

- ❖ The FIE assigns the organisation of the World Championships to the National Federation of the host city. This federation will create a World Championships Organising Committee, which, coordinating at all times with the National Federation, will, from its inception, communicate directly with the FIE, from whom it receives its instructions.
- ❖ The Organising Committee must comply with the Rules, Statutes, Administrative Rules and the Handbook of Regulations of the FIE from its inception up until its dissolution.
- ❖ The FIE retains the right of final say on all questions pertaining to the World Championships.
- ❖ The bid must be sent by the national federation and reach the FIE Head Office **three (3) years before** the date of organization of the World Championships, before the Congress. On this occasion the candidates will be announced.
- ❖ The complete file of candidature must reach the FIE Head Office before the 1<sup>st</sup> of September.
- ❖ The candidate federation will have to make a commitment, in front of the Congress, to respect the FIE Handbooks of regulations and its financial obligations. A signed protocol between the FIE and the organizing federation will state its perfect knowledge of its obligation
- ❖ The bid procedure has to take place according to the FIE statutes
- ❖ The Organising Federation must provide a written agreement from the Ministry of Foreign Affairs guaranteeing the granting of visas to all the participants of the member national federations of the FIE.
- ❖ As specified on the relevant articles of the questionnaire it is obligatory to present plans and dimensions of all the competition venues attached to this document.

**Do you herewith accept the presented FIE bidding rules, procedure and specified special requirements?                      YES                       NO**



## QUESTIONNAIRE

1. **Name of the Bidding Federation**

Estonian Fencing Association

2. **Bidding Event (tick the corresponding square)**

- Junior and Cadet World Championship

3. **Place and dates of the event**

Place City / Town: Tallinn

Dates: From 05.04. to 13.04. Year 2025

4. **Presentation of the City/Town**

- Present map with marked position of competition venues, hotels, airport, train station etc.

**MAP**

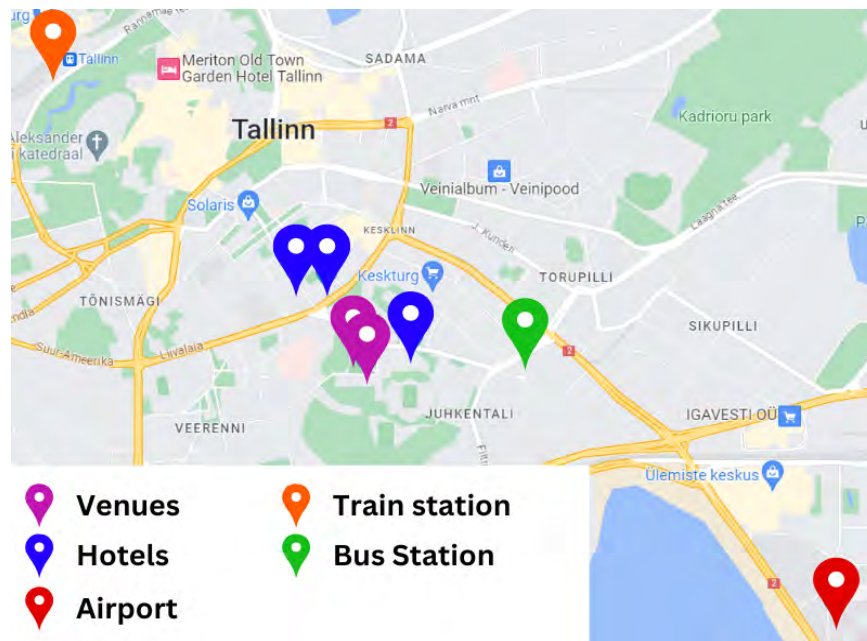

- City/Town details (Population, surface, climate, height etc.)  
Tallinn, Capital City of Estonia, Population 400 000. Tallinn has a population of about 454,000 (as of 2023) and administratively lies in the [Harju maakond \(county\)](#). Tallinn is the main financial, industrial, and cultural centre of Estonia. Daytime temperatures average 15.4 °C (59.7 °F), although nighttime temperatures still remain cool, averaging -3.7 to 5.2 °C (25.3 to 41.4 °F) from March to May. Snowfall is common in March and can occur in April.
- Present the major fencing competitions or other sports tournaments already organized in this city/town

Tallinn Glaive World Cup, U23 European Championships 2022, U17&U20 European Championships 2023.

## **5. Composition of the Organising Committee**

### **5.1 Organizing Committee Management**

Title	Surname	Name	Contact Details
President	Järvelaid	Peeter	+37256452476
Vice President	Märks	Heino	+3725057168
Secretary General	Paalberg	Aivar	+3725024394
Treasurer	Renser	Ruth	+37256563938

### **5.2 Organising Committee Important Portfolios**

Portfolio	Surname	Name	Contact Details
Administration	Märks	Meriliis	+37253470483
Invitation of Participants	Märks	Heino	+3725057168
Invitation of Officials	Ostrovski	Denis	+37256690552
Immigration and Visas	Kiis	Kaupo	+37258003800
Entries and Accreditations	Sel	Ana	+381645046340
Technical Organization	Dumitrov	Veselko	+381641292152
Venue Renting	Karavajev	Jevgeni	+37256609289
Telecommunications	Mänd	Moona-Liisa	+3725500554
IT Support	Scheer	Aleksander	+37253491600
Safety and Security	Märks	Uno	+37256568119
Accommodation	Loit	Meelis	+3725099401
Catering and Refreshments	Aujärv	Allan	+3725215122
Transportation	Tammeorg	Veiko	+3725063606
Technical Support	Meier	Jaan	+37256881404
Maintenance	Kaaberma	Kaido	+37256352410
Publicity and Promotion	Viil	Markus Johann	+37255970580
Press and Media Relations	Külvet	Grete	+37251962613
Relations with Officials	Jefimova	Maria	+37256669852
Call Room Services	Šitikov	Nikita	+37255560882
Equipment Control	Paalberg	Aivar (Jun)	+3725024394
Medical Service	Kuusk	Terje	+3725288034
Protocol	Kiis	Kaupo	+37258003800
Sound System	Kohver	Krister	+37259098418

## **6. Organising Committee Contact Details**

Physical Address: Kadaka tee 42N Tallinn 12915, Estonia

Postal address: Kadaka tee 42N Tallinn 12915, Estonia

Tel.: +3725043014

Fax: \_\_\_\_\_

E-mail: Heino.marks@vehklemisliit.ee      Url: \_\_\_\_\_

Mobile Phone: +3725057168

**7. Financing**

The following is detailed Budget of the event, with specified sources of the Income and estimated Expenditures:

**7.1 Income**

<b>Description</b>	<b>Amount (Currency)</b>
Public Subventions	
• National	250 000 EUR
• Regional	50 000 EUR
• Local	30 000 EUR
• Others	5000 EUR
Business Sponsors and Partners	20 000 EUR
Private Sponsors and Donors	10 000 EUR
Official providers	1000 EUR
Miscellaneous Sales	3000 EUR
• Tickets	-
• Rent of Stands	1500 EUR
• By-products	1000 EUR
• Catering and Refreshments	10 000 EUR
• TV Rights	
Other	200 000
<b>Total</b>	<b>581500</b>

**7.2 Expenditures**

<b>Description</b>	<b>Amount (Currency)</b>
• Accommodation	75000
• Accreditation	1500
• Administrators	35000
• Air conditioning	-
• Anti-doping service	16000
• Ceremonies and receptions	30000
• Cleaning	5000
• Computers, telephone, fax	10000
• Decoration	10000

• Electricity and water	3000
• Equipment	25000
• FIE guests, officials and VIP	20000
• Hostesses, Interpreters, Drivers etc....	30000
• Information/Public relations/Promotion:	10000
• Insurance	10000
• Medical service	10000
• Organising Committee	50000
• Officials	25000
• Other Expenses	10000
• Pistes and equipment specific to fencing	30000
• Promotion and Publicity	10000
• Referees	70000
• Results system	30000
• Security	10000
• Settings	10000
• Sound system, lights	25000
• Technicians	6000
• Transportation	40000
• Venues	60000
• Volunteers	20000
• Wireless	1000
<b>Total</b>	<b>581000</b>

**8. Official Support Documents from the National and/or Local Authorities**

Can you provide Official Support Documents from the National and/or Local Authorities (including visa guarantee letter)? YES  NO

If YES, these documents are to be listed and attached to this document.

Authority	Document
Ministry of Culture	Support letter

**9. Event Program**

Detailed Program of the event will be submitted to the FIE Executive committee for approval.

Typical program of the Junior and Cadet World Championship is as follows:

<b>DAY 1 - Friday</b>		
Junior Women's Sabre	Pools - DE 64 - Final	HALLS 1&2
Junior Men's Sabre	Pools - DE 64 - Final	HALLS 1&2
<b>DAY 2 - Saturday</b>		
Cadet Women's Sabre	Pools - DE 64 - Final	HALLS 1&2
Cadet Men's Sabre	Pools - DE 64 - Final	HALLS 1&2
<b>DAY 3 - Sunday</b>		
Junior Women's Sabre Team	DE 64 - Final	HALLS 1&2
Junior Men's Sabre Team	DE 64 - Final	HALLS 1&2
<b>DAY 4 - Monday</b>		
Junior Women's Foil	Pools - DE 64 - Final	HALLS 1&2
Junior Men's Foil	Pools - DE 64 - Final	HALLS 1&2
<b>Opening Ceremony</b>		HALLS 1&2
<b>DAY 5 - Tuesday</b>		
Cadet Women's Foil	Pools - DE 64 - Final	HALLS 1&2
Cadet Men's Foil	Pools - DE 64 - Final	HALLS 1&2
<b>DAY 6 - Wednesday</b>		
Junior Women's Foil Team	DE 64 - Final	HALLS 1&2
Junior Men's Foil Team	DE 64 - Final	HALLS 1&2
<b>DAY 7 - Thursday</b>		
Junior Women's Epee	Pools - DE 64 - Final	HALLS 1&2
Junior Men's Epee	Pools - DE 64 - Final	HALLS 1&2
<b>DAY 8 - Friday</b>		
Cadet Women's Epee	Pools - DE 64 - Final	HALLS 1&2
Cadet Men's Epee	Pools - DE 64 - Final	HALLS 1&2
<b>DAY 9 - Saturday</b>		
Junior Women's Epee Team	DE 64 - Final	HALLS 1&2
Junior Men's Epee Team	DE 64 - Final	HALLS 1&2
<b>Closing Ceremony</b>		HALL 2

**Do you herewith confirm that you will implement the presented Typical Program of the Junior and Cadet World Championship?**

YES  NO

### **10. Venue for the Competition**

Name of the Venue: Tallinna Spordihall, Kalevi korvpallihall

Address of the Venue: Herne 30

Number of the Available Halls:2

Number of Halls to be Used: 2

#### **10.1 Allocation of the Selected Halls:**

### 10.1.1 Preliminary Phase Halls

- Number of Preliminary Phase Halls: 1
- Dimensions of each Hall: 138,8 x 40,2m
- Number of Pistes at each Hall:31
- Total Number of Pistes: 42
- Average Width of the Refereeing Zone: 3m

### DRAWINGS OF THE PRELIMINARY PHASE HALLS

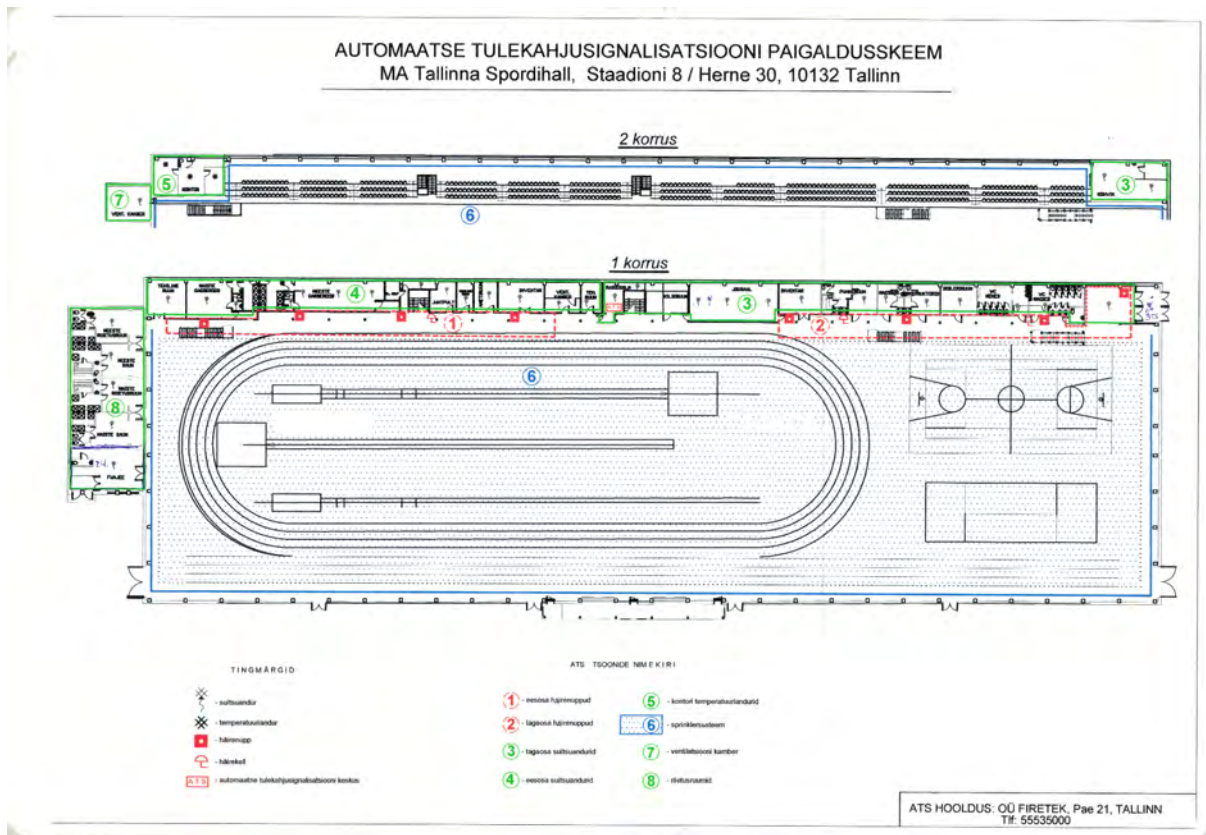
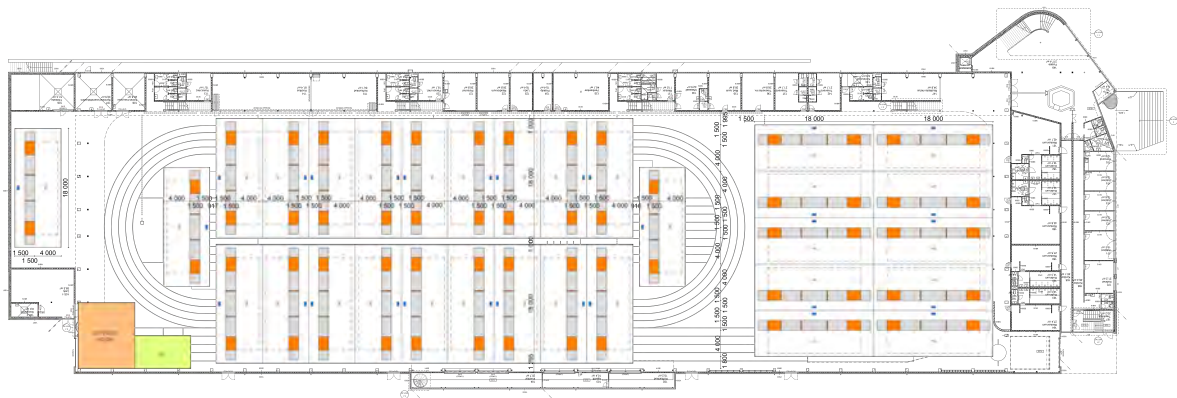

**10.1.2 Hall for the Direct Elimination and Finals with Single Piste and four (4) Coloured Pistes.**

**YES**  **NO**

- Blue carpet on the entire square four (4) Coloured Pistes and around podium (Final piste) **YES**  **NO**
- Dimensions of the Hall: 83,36 x 31,32 m
- Four (4) Coloured Pistes in different colours **YES**  **NO**
- Wireless System (optional) **YES**  **NO**
- Location for the Video-Refereeing Camera on the same side as the referee, outside of Refereeing zone **YES**  **NO**
- Video Refereeing Station on the same side as the referee, outside of Refereeing zone **YES**  **NO**
- One (1) Final Piste 1.5m to 2m wide, 18m Long **YES**  **NO**
- Piste on the podium 30 – 50cm raised, with lateral safety minimum 25cm and inclines at the end of the piste **YES**  **NO**
- Refereeing zone 4.0 – 4.5m from the piste **YES**  **NO**
- Wireless System (optional) **YES**  **NO**
- Location for the Video-Refereeing Camera on the same side as the referee, outside of Refereeing zone **YES**  **NO**
- Video Refereeing Station on the same side as the referee, outside of Refereeing zone (4.0 m minimum) **YES**  **NO**
- Wireless Microphone for the Referees **YES**  **NO**

**DRAWINGS OF THE HALL FOR DIRECT ELIMINATION AND FINALS**

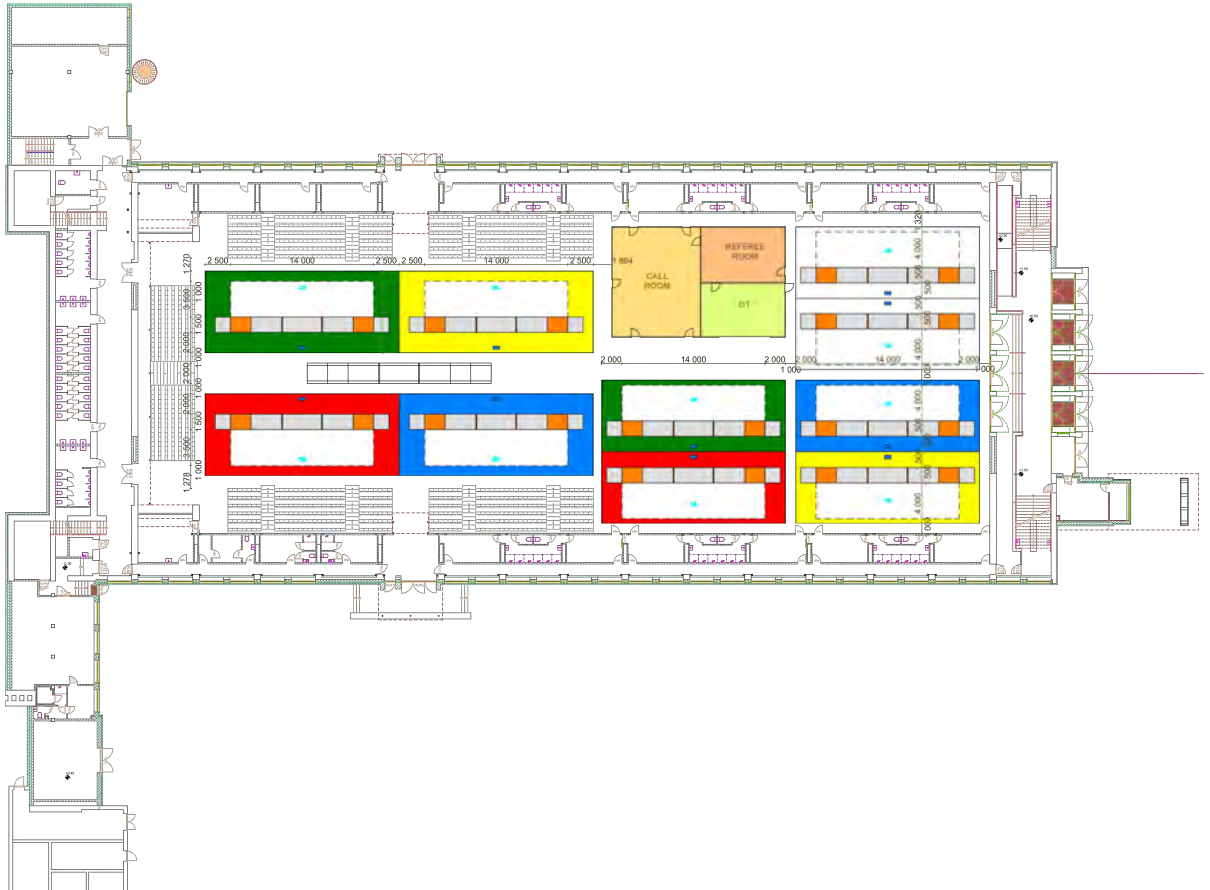

**10.1.3 Training Halls**

YES  NO

- Number of Training Halls: Training pistes are located in the preliminary phase hall.
- Dimensions of the Halls:
- Total Number of Pistes: 11
- Total Number of Team boxes 50
- Team box dimensions (for National team) 3m x 4m

**10.1.4 Warm-up Halls**

YES  NO

- Number of Warm-up Halls: we have warm-up pistes in the preliminary phase hall and in direct elimination and finals hall.

**10.2 Capacity of Spectators per Each Hall**

Preliminary Phase Halls: 2000

Hall for the Direct Elimination and the Finals: 4000

**10.3 Rest rooms for the Athletes**

YES  NO

- Number of Rest Rooms for Athletes: 16
- Dimensions of Rest Rooms: 15 m<sup>2</sup>



#### 10.4 Rooms for Control of Weapons and Equipment

- Size of the selected room 180 m<sup>2</sup> (Minimum 150m<sup>2</sup>)
- Room must be operational and open 72 hours before the beginning of the first event. Is that realisable? **YES**  **NO**

#### 10.5 Office of Directoire Technique

- Size of the selected room 200 m<sup>2</sup> (Recommended 150-200m<sup>2</sup>)
- Internet access and ADSL/Fiber Optic Line **YES**  **NO**
- Six (6) Tables of 2m length **YES**  **NO**
- Two (2) Computers for administration **YES**  **NO**
- Two (2) Computers with Printers **YES**  **NO**
- Reserve set of equipment (computers, printers, cartridges etc.) **YES**  **NO**
- One (1) High-performance Photocopier **YES**  **NO**
- Telephone Line and Telephone **YES**  **NO**
- Two (2) Wireless Microphones **YES**  **NO**
- Notice Board **YES**  **NO**

#### 10.6 Other rooms and halls (tick the existing)

- FIE Offices Size: 40 m<sup>2</sup>
- President's office Size: 30 m<sup>2</sup>
- Secretary General/Treasurer's office Size:30 m<sup>2</sup>
- FIE Meetings Room Size: 60 m<sup>2</sup>
- OC Room Size: 50 m<sup>2</sup>
- Referees Room (min 150m<sup>2</sup>) Size: 160 m<sup>2</sup>
- Doping Control Station Size: 30 m<sup>2</sup>
- Accreditation Room (min 100m<sup>2</sup>) Size: 120 m<sup>2</sup>
- Information Centre Size:60 m<sup>2</sup>
- Press Centre (equipped) Size: 100 m<sup>2</sup>
- Conference Room Size: 120 m<sup>2</sup>
- FIE Stands (DYFG, Clean sport, Safe sport, others) Size:30 m<sup>2</sup>
- Fencing equipment suppliers Size: 200 m<sup>2</sup>
- Other Size: 100 m<sup>2</sup>

#### 10.7 Specification and Description of the Equipment available in Each Room

We will equip all rooms with necessary equipment.

#### 10.8 Catering Facilities at the Venue

- Number of Restaurants 2
- Number of Snacks (Sandwiches and fast Food Service) 4
- Number of Drinks Sale Services 4
- Number of Tuck Shops 2

**10.9 Food and Refreshment Prices (Attach Price Lists)**

Lunch between 9-11 EUR

**10.10 Staff in the Venue**

- Professionals                        Number: 30
- Volunteers                            Number:50

**11. Material and Equipment**

a) Name of the supplier of fencing material and equipment for Weapon Control:

Favero

b) List of equipment for weapon control:

Favero, Allstar

c) Name of the supplier of fencing material and equipment: for fencing halls

Favero

d) Name of apparatus and reels (supplier/model):

Favero FA 7

e) Name of supplier of fencing pistes:

Uhlmann

f) Name of software for the management of the competitions:

Fencingtime

g) Name of the person in charge of computers in the OC:

Roman Zoltan

h) Number of computers for the management of the competitions:

20

i) Name of the person in charge of computers in the OC:

Aivar Paalberg

**12. Accommodation and Transportation**

**12.1 Available International Travel Options**

- Airplane                        Name of the Airport Tallinn

- Train  Name of the Station Tallinn
- Other  Details: International Bus Station

### 12.2 Category, Number and Prices of the Officially Selected Hotels

Venue	Number of Hotels	Price P/P Single Room	Price P/P Double Room	Price P/P Breakfast
Hotel Category 1	2	80 EUR	60 EUR	included
Hotel Category 2	1	70 EUR	50 EUR	Included
Hotel Category 3				
Hotel Category 4				
Hotel Category 5				
Other Accommod.				

### 12.3 Distance between the Airport / Railway Station and Hotels

Venue	Distance (km)	Timing (hrs)
Hotel Category 1	5 km	15 min
Hotel Category 2	5 km	15 min
Hotel Category 3		
Hotel Category 4		
Hotel Category 5		
Other Accommod.		

### 12.4 Distance between Hotels and Competition Venue

Venue	Distance (km)	Timing (hrs)
Hotel Category 1	500 m	
Hotel Category 2	300 m	
Hotel Category 3		
Hotel Category 4		
Hotel Category 5		
Other Accommod.		

### 12.5 Arrangement for Transportation of Delegations

Transport Description	Bus	Mini-Bus	Shuttle	Other	Price
From Airport/ Station to Hotels	X	X	X		20 EUR

From Hotels to Competition Venues	Walking distance				
From Hotels to Training Venues	Walking distance				

**12.6 Arrangement for Transportation of Officials**

Transport Description	Bus	Mini-Bus	Shuttle	Other	Price
From Airport/ Station to Hotels		X			
From Hotels to Competition Venues		X			

**13. Publicity and Promotion**

What publicity and promotion methods you plan to use:

- Advertisements on Radio
- Advertisements on TV
- Press conferences
- Street Posters and Bans
- Dedicated website/social media
- Other

Present details of the publicity and promotion plan: Complete plan will be ready one year before championships

**14. Tickets and Derived Products**

- How many tickets you expect to sell during the WC? Free Entry
- What price of tickets you will apply? 0

**15. Press Coverage**

Press coverage of the World Championship must be in line with the FIE Press Handbook.

**Do you herewith confirm that you are committed to implement the FIE Press Handbook?** YES  NO

16. **Television Coverage**

TV coverage of the World Championship must be in line with the FIE Television Handbook.

**Do you herewith confirm that you are committed to implement the FIE Television Handbook?** YES  NO

**16.1 Details of the Television Coverage Plan**

- National TV Channels
  - Live Broadcast  Number of Hours: \_\_\_\_\_
  - Recorded Broadcast  Number of Hours: 6
- Regional TV Channels
  - Live Broadcast  Number of Hours: \_\_\_\_\_
  - Recorded Broadcast  Number of Hours: 6
  - o Other

Present details of the TV Coverage plan: Will be ready a year before championships

## **17. Marketing plan**

### **17.1 Details of the Marketing Plan**

Advertisement in national broadcasts  
 Advertisement in Cinemas  
 Competition homepage  
 Competition App  
 Advertisement in radio channels  
 Advertisement in public transport

**17.2 Date when the complete Marketing Plan will be submitted to the FIE 01.09.2024**

## **18. Sponsors**

### **18.1 Sponsors Selection**

Organising Committee cannot approach or make sponsorship arrangements with any company that is a competitor with the major FIE sponsors.

**Do you herewith confirm that you will comply with presented criteria for selection of the sponsors? YES  NO**

**Do you herewith confirm that you are committed to implement Requirements that are specified in the FIE Press Handbook and the FIE Handbook of Regulations for WC? YES  NO**

**18.2 Date when the complete List of Sponsors will be submitted to the FIE 01.09.2024**

## **19. Protocol**

The protocol ceremonies must be organised as specified in the FIE Handbook of Regulations for the Organization of Protocol Ceremonies at FIE Competitions.

The FIE Chief of Protocol coordinates with the LOC Protocol Manager to ensure that all elements of FIE protocol are respected.

**Do you herewith confirm that Protocol will be organised according to this FIE document? YES  NO**

## **20. Medical Service**

Medical Service is to be provided in accordance for by the FIE Rules, the FIE Administrative Rules, the FIE Handbooks of Regulations and FIE Medical Handbook.

**Do you herewith confirm that you will comply organization of the Medical Service with the listed FIE Documents? YES  NO**

Medical Service is covering Medical Emergencies, Sports Trauma, General Medical Care and Additional Medical Services (Physiotherapy etc.).

Basic requirements are as follows

- Medical Stations, with locally licenced paramedic or doctor, must be present in competition halls, **MAXIMUM two (2) minutes away from the furthest hall**, and properly marked;
- Adequate ambulance must be present on site or **MAXIMUM at ten (10) minutes' drive distance**;
- Hospital with the emergency ward and facilities required for treatment of the possible injuries and illnesses must be selected and arrangements made for adequate support in case of emergency;

**Do you herewith confirm that you will meet Medical Service requirements? YES  NO**

## **21. Doping Control**

According to the FIE Anti-Doping Rules, Doping Control tests are obligatory at all World Championships.

Testing process must be strictly managed according to the WADA regulations.

Doping Control Office (DCO) must be supplied by the National Anti-Doping Organization (NADO).

Analysis of the samples must be performed by the IOC accredited laboratory. Coordinator of the doping control is the FIE Medical Delegate.

Doping Control station must be allocated as close as possible to the Finals venue, with all required facilities to accommodate limited access, privacy, preparation of the documentation, taking and processing samples.

Sample collection bottles, containers and forms are to be supplied the NADO.

**Do you herewith confirm that you will meet Doping Control requirements according to these regulations? YES  NO**

## **22. Security**

The Organizing Committee has to organise Security and Safety Service in order to provide:

- The health and physical security of all the participants;
- Safety of all the installed equipment;
- Regulation of access to various sites of the competition in line with the applied accreditation;
- No unauthorised access of the pistes and official rooms by the public;
- Good and safe circulation of people;

Also, discreet police service and the presence of a fire service is to be planned.

**Do you herewith confirm that you will meet presented Security requirements? YES  NO**

### **23. Insurance**

The Organising Committee must, at its own costs, institute:

- Liability Insurance policy which will include general liability coverage, as well as a guarantee for non-consecutive intangible damages (pure financial loss).
- All other mandatory insurance, such as:
  - ❖ Fire and fire damage insurance policies for premises necessary to the organisation
  - ❖ Automobile insurance policies (if necessary)
  - ❖ All policies mandated by local legislation.
- Repatriation Assistance coverage for the Fencing family, but without covering the designated officials or referees, the Executive Committee, or FIE personnel.

**Do you herewith confirm that you will meet presented Insurance requirements?**

**YES  NO**

### **24. Rewards for the Winners**

**YES  NO**

Present details of the planned Rewards for the Winners: medals, Cups, flowers

### **25. Cultural Programme Plan**

**YES  NO**

Present details of the Cultural Plan:  
Guided visit to Tallinn Old Town

### **26. Environmental Protection Plan**

**YES  NO**

Present details of the Environmental Protection Plan: We do not use single-use utensils



International Fencing Federation

03.05.2023 No 8-3/679-1

### **Cadet and Junior World Championships 2025**

This letter is to confirm that Ministry of Culture of the Republic of Estonia is aware of and fully supports the Estonian Fencing Association bid to organize fencing Cadet and Junior World Championships in 2025 in Estonia.

Taking into account the long traditions of and the success in fencing it would be an honour to host the fencing Cadet and Junior World Championships two year after the successful Cadet and Junior European Championships in Estonia.

Ministry of Culture of the Republic of Estonia is ready to co-operate with the event organisers in order to guarantee the best possible organisation of the event. The amount of the financial support will be decided at the end of this year in line with the terms of the public call for application.

Visas, where required, will be granted promptly according to Estonian legislation.

Yours sincerely,

Tarvi Sits  
Secretary General

Margus Klaan +372 628 2328  
margus.klaan@kul.ee





# EESTI VEHKLEMISLIIT

Kadaka tee 42n  
12915 Tallinn  
Eesti

tel: +3725024394  
E-post: [evl@vehklemisliit.ee](mailto:evl@vehklemisliit.ee)  
[www.vehklemisliit.ee](http://www.vehklemisliit.ee)

## Letter of commitment

The national federation of Estonia

hereby bidding to the organisation of the World Championships of 2025 for cadets and juniors.

- 1) Hereby confirms that it has full knowledge of all its obligations and financial obligations to organise an FIE World Championships
- 2) Hereby confirms that it is committed:
  - a) to respect and implement the FIE Statutes, including articles 1.2.4 and 1.2.5, the FIE Ethics and Safeguarding codes, the FIE rules, the FIE Administrative Rules, the FIE handbook of regulations, FIE Protocol handbook and any FIE rule in force.
  - b) to respect Its financial obligations
- 3) confirms that it has received from its national authorities a written agreement guaranteeing the granting of visas to all the participants of the member national federations of the FIE.

23.08.2023 Tallinn





**BID QUESTIONNAIRE**

**FOR ORGANISATION**

**OF THE SENIOR FENCING WORLD CHAMPIONSHIPS**

## IMPORTANT INFORMATION FOR BIDDING FEDERATIONS

- ❖ The FIE assigns the organisation of the World Championships to the National Federation of the host city. This federation will create a World Championships Organising Committee, which, coordinating at all times with the National Federation, will, from its inception, communicate directly with the FIE, from whom it receives its instructions.
- ❖ FIE World Championships and other official FIE events are only assigned to National Member Federations who ensure free access to competitors and officials and whose Organizing Committees commit to send invitations to all the Federations having the right to take part, and who do everything in their power to obtain the visas needed.
- ❖ The Organising Committee must comply with all the FIE Rules, Statutes, Administrative Rules and the Handbook of Regulations of the FIE from its inception up until its dissolution. The member Federation which applies as a candidate to organise congresses, official competitions, or any other FIE international events will document that the organizer will use all means to enable all the member Federations to take part in those events, without any discrimination whatever.
- ❖ The Organising Committee must comply with the Rules, Statutes, Administrative Rules and the Handbook of Regulations of the FIE from its inception up until its dissolution.
- ❖ The FIE retains the right of final say on all questions pertaining to the World Championships.
- ❖ The bid must be sent by the national federation and reach the FIE Head Office **three (3) years before** the date of organization of the World Championships, before the Congress. On this occasion the candidates will be announced.
- ❖ The complete file of candidature must reach the FIE Head Office before the 1<sup>st</sup> of September.
- ❖ The candidate federation will have to make a commitment, in front of the Congress, to respect the FIE Handbooks of regulations and its financial obligations. A signed protocol between the FIE and the organizing federation will state its perfect knowledge of its obligation
- ❖ The bid procedure has to take place according to the FIE statutes
- ❖ The Organising Federation must provide a written agreement from the Ministry of Foreign Affairs guaranteeing the granting of visas to all the participants of the member national federations of the FIE.
- ❖ As specified on the relevant articles of the questionnaire it is obligatory to present plans and dimensions of all the competition venues attached to this document.



Do you herewith accept the presented FIE bidding rules, procedure and specified special requirements? YES  NO

## QUESTIONNAIRE

1. **Name of the Bidding Federation**

Fencing Federation of Georgia

2. **Bidding Event (tick the corresponding square)**

- Senior World Championship

3. **Place and dates of the event**

Place City / Town: Tbilisi, Georgia

Dates: From 20 July To 30 July Year 2025

4. **Presentation of the City/Town**

- Present map with marked position of competition venues, hotels, airport, train station etc.

**MAP**



- City/Town details (Population, surface, climate, height etc.)

Country Georgia

Flag Georgia



Tbilisi region

Internal division Gldani district, Didube, Vaki district, Isni district, Krtsanisi, Mtatsminda district, Nadzaladevi, Saburtalo district, Samgori district and Chugureti

Coordinates 41°43'21" H. c. 44°47'33" a. c.

First mention V century

Early names Tiflis

Area 720 km<sup>2</sup>

The official language is Georgian

Population 1 118 035 (2014)

Density 3,194.38 people/km<sup>2</sup>

Time zone UTC+04:00

Telephone code (32)

Postal code 0100–0199

Official website <http://www.tbilisi.gov.ge/>

- Present the major fencing competitions or other sports tournaments already organized in this city/town  
World Cups, satellites, cadets circuits

## **5. Composition of the Organising Committee**

### **5.1 Organizing Committee Management**

Title	Surname	Name	Contact Details
President	Bazadze	Merabi	557475757
Vice President	Jashi	Varlam	599226688
Secretary General	Jerenashvili	Nino	593000026
Treasurer	Samanishvili	Beka	598464542

## 5.2 Organising Committee Important Portfolios

Portfolio	Surname	Name	Contact Details
Administration	Jerenashvili	Nino	593000026
Invitation of Participants	Jerenashvili	Nino	593000026
Invitation of Officials	Jerenashvili	Nino	593000026
Immigration and Visas	Jerenashvili	Nino	593000026
Entries and Accreditations	Darsavelidze	Tatia	598434415
Technical Organization	Arveladze	David	555142140
Venue Renting	Olympic palace		
Telecommunications	Minashvili/Prangishvili	David/David	577171707/577402045
IT Support	Lukianov	Alexander	591120788
Safety and Security	company Delta+		
Accommodation	Jashi	Varlam	593000026
Catering and Refreshments	Jashi	Varlam	599226688
Transportation	Company		
Technical Support	Arveladze	David	555142140
Maintenance	Company		
Publicity and Promotion	Gloveli	Salome	598515415
Press and Media Relations	Gloveli	Salome	598515415
Relations with Officials	Gloveli	Salome	598515415
Call Room Services	Darsavelidze	Tatia	598434415
Equipment Control	Darsavelidze	Tatia	598434415
Medical Service	Makhviladze	Giorgi	598687579
Protocol	Abashidze	Rostom	597904424
Sound System	Company		

## 6. Organising Committee Contact Details

Physical Address: Chavchavadze 49b, Tbilisi, Georgia

Postal address: 0182

Tel.: 032 2292875

Fax: \_\_\_\_\_

E-mail: [fencinggeo@gmail.com](mailto:fencinggeo@gmail.com)

Url: \_\_\_\_\_

Mobile Phone: +995 593000026

## 7. Financing

The following is detailed Budget of the event, with specified sources of the Income and estimated Expenditures:

### 7.1 Income

<b>Description</b>	<b>Amount (Currency)</b>
Public Subventions	1 000 000 EUR
• National	35 000 EUR
• Regional	170 000 EUR
• Local	170 000 EUR
• Others	
Business Sponsors and Partners	100 000 EUR
Private Sponsors and Donors	35000 EUR
Official providers	NOC
Miscellaneous Sales	
• Tickets	500 EUR
• Rent of Stands	1500 EUR
• By-products	
• Catering and Refreshments	5000 EUR
• TV Rights	1500 EUR
Other	
<b>Total</b>	<b>1518500 EUR</b>

## 7.2 Expenditures

<b>Description</b>	<b>Amount (Currency)</b>
• Accommodation	50 000 EUR
• Accreditation	3000 EUR
• Administrators	7000 EUR
• Air conditioning	7000 EUR
• Anti-doping service	18000 EUR
• Ceremonies and receptions	3500 EUR
• Cleaning	1500 EUR
• Computering, telephone, fax	1500 EUR
• Decoration	7000 EUR
• Electricity and water	500 EUR
• Equipment	18000 EUR
• FIE guests, officials and VIP	10000 EUR
• Hostesses, Interpreters, Drivers etc....	9000 EUR
• Information/Public relations/Promotion:	13000 EUR
• Insurance	1500 EUR
• Medical service	30000 EUR
• Organising Committee	18000 EUR
• Officials	3500 EUR
• Other Expenses	35000 EUR
• Pistes and equipment specific to fencing	170000 EUR
• Promotion and Publicity	3500 EUR
• Referees	35000 EUR

• Results system	18000 EUR
• Security	18000 EUR
• Settings	1500 EUR
• Sound system, lights	10000 EUR
• Technicians	28000 EUR
• Transportation	500 000 EUR
• Venues	100 000 EUR
• Volunteers	18000 EUR
• Wireless	10000 EUR
<b>Total</b>	<b>1 149 000 EUR</b>

### 7.3 Financial Guarantees

The **organizing federation** is committed to produce a guarantee to the FIE, three months before the date of the World championships, for the amount of **100 000 euro**, either by a **deposit**, or by a **bank guarantee**.

**Do you herewith confirm that you will present the Financial Guarantees?**

**YES**  **NO**

Transfer confirmation document or Bank Guarantee must be attached to this document.

The balance of the deposit or the guarantee will be returned to the organizing federation within one month after the end of the World championships if all requirements of the FIE have been fulfilled.

### 8. Official Support Documents from the National and/or Local Authorities

**Can you provide Official Support Documents from the National and/or Local Authorities (including visa guarantee letter)?**

**YES**  **NO**

If YES, these documents are to be listed and attached to this document.

Authority	Document

### 9. Event Program

Detailed Program of the event will be submitted to the FIE Executive committee for approval.

Typical program of the Senior World Championship is as follows:

DAY 1 - Monday		
Women's Epee	Pools, Preliminary DE up to 64	HALLS _____
Men's Sabre	Pools, Preliminary DE up to 64	HALLS _____



FIE Bid Questionnaire for Senior World Championships

<b>DAY 2 - Tuesday</b>		
Women's Foil	Pools, Preliminary DE up to 64	HALLS _____
Men's Epée	Pools, Preliminary DE up to 64	HALLS _____
<b>DAY 3 - Wednesday</b>		
Women's Sabre	Pools, Preliminary DE up to 64	HALLS _____
Men's Foil	Pools, Preliminary DE up to 64	HALLS _____
<b>DAY 4 – Thursday</b>		
Women's Epee individual	T64 - Final	HALLS _____
Men's Sabre individual	T64 -Final	HALLS _____
<b>Opening Ceremony</b>		HALLS _____
<b>DAY 5 - Friday</b>		
Women's Foil individual	T64 -Final	HALLS _____
Men's Epee individual	T64 - Final	HALLS _____
<b>DAY 6 – Saturday</b>		
Women's Sabre individual	T64 -Final	HALLS _____
Men's Foil individual	T64 -Final	HALLS _____
Women's Epee Team	T64 up to 8	HALLS _____
Men's Sabre Team	T64 up to 8	HALLS _____

<b>DAY 7 – Sunday</b>		
Women's Epee Team	T8 - 3 place- 1 place	HALLS _____
Men's Sabre Team	T8 3 place- 1 place	HALLS _____
Women's Foil Team	T64 up to 8	HALLS _____
Men's Epee Team	T64 up to 8	HALLS _____
<b>DAY 8 – Monday</b>		
Women's Foil Team	T8 3 place- 1 place	HALLS _____
Men's Epee Team	T8 3 place- 1 place	HALLS _____
Women's Sabre Team	T64 up to 8	HALLS _____
Men's Foil Team	T64 up to 8	HALLS _____
<b>DAY 9 - Tuesday</b>		
Women's Sabre Team	T8 3 place- 1 place	HALLS _____
Men's Foil Team	T8 3 place- 1 place	HALLS _____
<b>Closing Ceremony</b>		HALL _____

**Do you herewith confirm that you will implement the presented Typical Program of the Senior World Championship?** YES  NO

**10. Venue for the Competition**

Name of the Venue: Tbilisi Olympic Palace

Address of the Venue: 15a University Street, Tbilisi 0186

Number of the Available Halls: 3 \_\_\_\_\_

Number of Halls to be Used: 3 \_\_\_\_\_

**10.1 Allocation of the Selected Halls:**

**10.1.1 Preliminary Phase Halls**

- Number of Preliminary Phase Halls: 3 \_\_\_\_\_
- Dimensions of each Hall: \_\_\_\_\_
- Number of Pistes at each Hall: 36 (35 + 1 for PODIUM)
- Average Width of the Refereeing Zone: \_\_\_\_\_

**DRAWINGS OF THE PRELIMINARY PHASE HALLS**

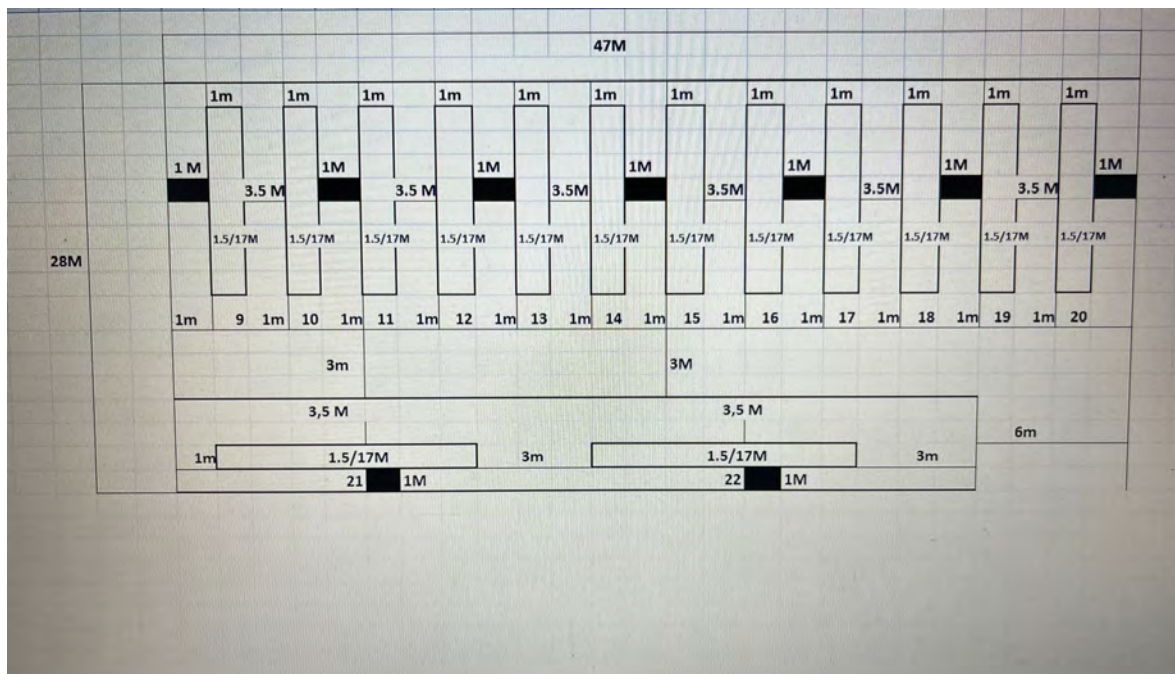

**10.1.2 Hall for the Direct Elimination**

- Dimensions of the Hall: \_\_\_\_\_
- Four (4) Coloured Pistes in different colours **YES**  **NO**
- Wireless System **YES**  **NO**

- Location for the Video-Refereeing Camera on the same side as the referee, outside of Refereeing zone **YES**  **NO**
- Video Refereeing Station on the same side as the referee, outside of refereeing zone **YES**  **NO**

**DRAWING OF THE HALL FOR DIRECT ELIMINATION**

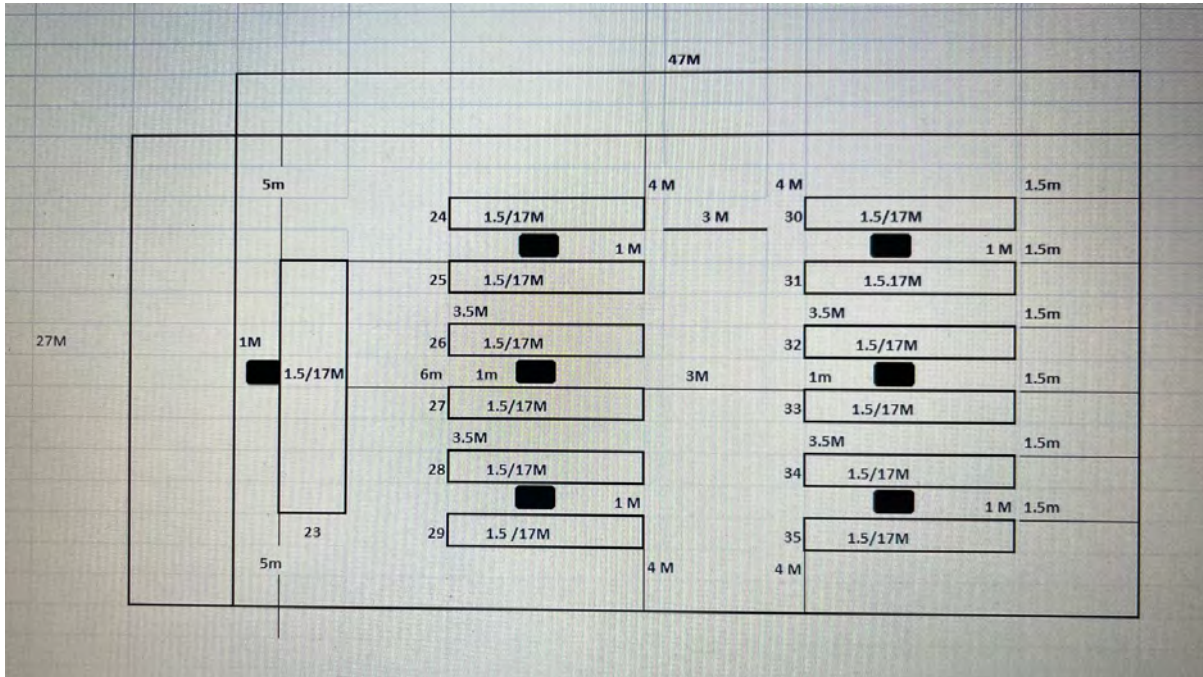

- 10.1.3 Hall for the Finals – Single Piste** **YES**  **NO**
- Blue carpet on the entire square four (4) Coloured Pistes around podium (Final piste) **YES**  **NO**

- Dimensions of the Hall: \_\_\_\_\_
- One (1) Piste 1.5m to 2m wide, 18m Lng **YES**  **NO**
- Piste on the podium 30 – 50cm raised, with lateral safety minimum 25cm and inclines at the end of the piste **YES**  **NO**
- Refereeing zone 4.0 – 4.5m from the piste **YES**  **NO**
- Wireless System **YES**  **NO**
- Location for the Video-Refereeing Camera on the same side as the referee, outside of Refereeing zone **YES**  **NO**
- Video Refereeing Station on the same side as the referee, outside of Refereeing zone (4.0m minimum) **YES**  **NO**
- Wireless Microphone for the Referees **YES**  **NO**

**DRAWING OF THE HALL FOR FINALS**

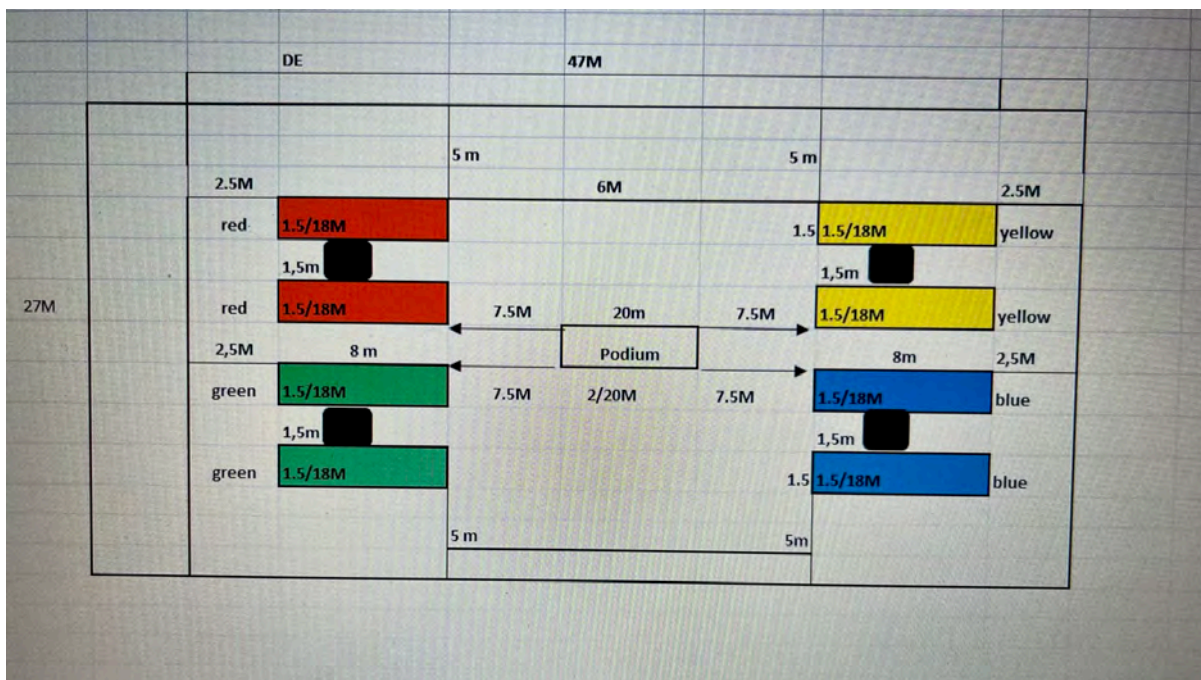

**10.1.4 Hall for the Direct Elimination and Finals with Single Piste and four (4)**

**Coloured Pistes.**

- |   |            |                                     |           |                          |
|---|------------|-------------------------------------|-----------|--------------------------|
|   | <b>YES</b> | <input checked="" type="checkbox"/> | <b>NO</b> | <input type="checkbox"/> |
| • Blue carpet on the entire square four (4) Coloured Pistes and around podium (Final piste)                   | <b>YES</b> | <input checked="" type="checkbox"/> | <b>NO</b> | <input type="checkbox"/> |
| • Dimensions of the Hall: _____   |            |                                     |           |                          |
| • Four (4) Coloured Pistes in different colours   | <b>YES</b> | <input checked="" type="checkbox"/> | <b>NO</b> | <input type="checkbox"/> |
| • Wireless System   | <b>YES</b> | <input checked="" type="checkbox"/> | <b>NO</b> | <input type="checkbox"/> |
| • Location for the Video-Refereeing Camera on the same side as the referee, outside of Refereeing zone        | <b>YES</b> | <input checked="" type="checkbox"/> | <b>NO</b> | <input type="checkbox"/> |
| • Video Refereeing Station on the same side as the referee, outside of Refereeing zone                        | <b>YES</b> | <input checked="" type="checkbox"/> | <b>NO</b> | <input type="checkbox"/> |
| • One (1) Final Piste 1.5m to 2m wide, 18m Long   | <b>YES</b> | <input checked="" type="checkbox"/> | <b>NO</b> | <input type="checkbox"/> |
| • Piste on the podium 30 – 50cm raised, with lateral safety minimum 25cm and inclines at the end of the piste | <b>YES</b> | <input checked="" type="checkbox"/> | <b>NO</b> | <input type="checkbox"/> |
| • Refereeing zone 4.0 – 4.5m from the piste   | <b>YES</b> | <input checked="" type="checkbox"/> | <b>NO</b> | <input type="checkbox"/> |
| • Wireless System   | <b>YES</b> | <input checked="" type="checkbox"/> | <b>NO</b> | <input type="checkbox"/> |
| • Location for the Video-Refereeing Camera on the same side as the referee, outside of Refereeing zone        | <b>YES</b> | <input checked="" type="checkbox"/> | <b>NO</b> | <input type="checkbox"/> |
| • Video Refereeing Station on the same side as the referee, outside of Refereeing zone (4.0 m minimum)        | <b>YES</b> | <input checked="" type="checkbox"/> | <b>NO</b> | <input type="checkbox"/> |
| • Wireless Microphone for the Referees  | <b>YES</b> | <input checked="" type="checkbox"/> | <b>NO</b> | <input type="checkbox"/> |

**DRAWINGS OF THE HALL FOR DIRECT ELIMINATION AND FINALS**

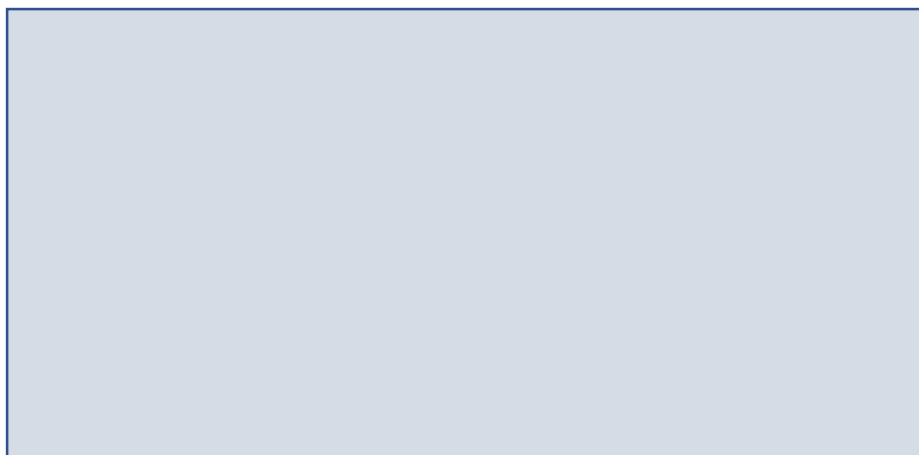

**10.1.5 Training Halls**

**YES**  **NO**

- Number of Training Halls: 4 \_\_\_\_\_
- Dimensions of the Halls: \_\_\_\_\_
- Total Number of Pistes: 60 + \_\_\_\_\_
- Total Number of Team boxes \_\_\_\_\_
- Team box dimensions (for National team) 3mx4m \_\_\_\_\_

**10.1.6 Warm-up Halls**

**YES**  **NO**

- Number of Warm-up Halls: 5 \_\_\_\_\_

**10.2 Capacity of Spectators per Each Hall**

Preliminary Phase Halls: \_\_\_\_\_  
 Hall for the Direct Elimination: 3-4 \_\_\_\_\_  
 Hall for the Finals: 1 \_\_\_\_\_

**10.3 Rest rooms for the Athletes**

**YES**  **NO**

- Number of Rest Rooms for Athletes: 5 \_\_\_\_\_
- Dimensions of Rest Rooms: 100m<sup>2</sup>,  
150m<sup>2</sup> \_\_\_\_\_

**10.4 Rooms for Control of Weapons and Equipment**

- Size of the selected room 160 m<sup>2</sup> (Minimum 150m<sup>2</sup>.)
- Room must be operational and open 72 hours before the beginning of the first event. Is that realisable? **YES**  **NO**

**10.5 Office of Directoire Technique**

- Size of the selected room 200 m<sup>2</sup> (Recommended 150-200m<sup>2</sup>.)
- Internet access and ADSL/Fiber Optic Line **YES**  **NO**
- Six (6) Tables of 2m length **YES**  **NO**
- Two (2) Computers for administration **YES**  **NO**
- Two (2) Computers with Printers **YES**  **NO**
- Reserve set of equipment (computers,



- |  |   |                             |
|--|---|-----------------------------|
| printers, cartridges etc.)             | YES <input checked="" type="checkbox"/> | NO <input type="checkbox"/> |
| • One (1) High-performance Photocopier | YES <input checked="" type="checkbox"/> | NO <input type="checkbox"/> |
| • Telephone Line and Telephone         | YES <input checked="" type="checkbox"/> | NO <input type="checkbox"/> |
| • Two (2) Wireless Microphones         | YES <input checked="" type="checkbox"/> | NO <input type="checkbox"/> |
| • Notice Board                         | YES <input checked="" type="checkbox"/> | NO <input type="checkbox"/> |

**10.6 Other rooms and halls (tick the existing)**

- FIE Offices Size: 100
- President's office Size: 40
- Secretary General/Treasurer's office Size: 30
- FIE Meetings Room Size: 30
- OC Room Size: 30
- Referees Room (min 150m2) Size: 170
- Doping Control Station Size: 30
- Accreditation Room (min 100m2) Size: 70
- Information Centre Size: 40
- Press Centre (equipped) Size: 40
- Conference Room Size: 80
- FIE Stands (DYFG, Clean sport, Safe sport, others) Size: 100
- Fencing equipment suppliers Size: 200
- Other Size: 100

**10.7 Specification and Description of the Equipment available in Each Room**

1. Two Computers for administration
2. Two Computers with Printers
3. Reserve set of equipment (computers, printers, cartridges etc.)
4. One High-performance Photocopier
5. Telephone Line and Telephone
6. Two Wireless Microphones
7. Tables

**10.8 Catering Facilities at the Venue**

- Number of Restaurants 3
- Number of Snacks (Sandwiches and fast Food Service) 3
- Number of Drinks Sale Services 3
- Number of Tuck Shops 3 \_\_\_\_\_

**10.9 Food and Refreshment Prices (Attach Price Lists)**

**Number of Restaurants - 3**

\* **1 location will be a food court, and 2 locations will be snacks and drinks (hot, soft drinks).**

\* **Number of snacks** (sandwiches and fast food service) 3 points will be presented at the main location (cheese and ham sandwich, chicken sandwich, vegetarian sandwich, salmon sandwich). Only 1 food at the main location.

\* **Number of drinks sale services** 3 -1 will be presented at the main catering facility (alcoholic and non-alcoholic), and at 2 locations there will be hot and soft drinks, alcoholic beverages (beer, wine, etc.) will be additionally presented.

\* **Food and refreshments prices** (attach price lists) - Here we present the expected prices, which may change, depending on exchange rate changes. (Attached please find the price list).

Besides traditional Georgian dishes, mixed European cuisine will also be presented (pizza, pasta and canapés)

We are attaching the MENU and price list which provided by restaurant. (please see). Please foresee that MENU is in GEL and the for today 1 EUR is = 2,81 GEL

**10.10 Staff in the Venue**

- Professionals  Number: 100 \_\_\_\_\_
- Volunteers  Number: 100 \_\_\_\_\_

**11. Material and Equipment**

a) Name of the supplier of fencing material and equipment for Weapon Control:  
 \_\_\_Allstar\_\_\_\_\_

b) List of equipment for weapon control:

\_2 Gabarits (to check length and flexibility of weapons and blades)

4 test boxes (to check resistance of cables, weapons and electric jackets)

Gauge for checking weapons;

Electrical tester and equipment for checking the wire, electric jacket, mask, gloves and weapons;

Market for the blades;

c) Name of the supplier of fencing material and equipment: for fencing halls  
 ALLSTAR

d) Name of apparatus and reels (supplier/model):

ALLSTAR

- e) Name of supplier of fencing pistes:  
ALLSTAR
- f) Name of software for the management of the competitions:  
ENGARDE\_\_\_\_\_
- g) Name of the person in charge of computers in the OC: David  
Arveladze\_\_\_\_\_
- h) Number of computers for the management of the competitions:  
30\_\_\_\_\_

## 12. Accommodation and Transportation

### 12.1 Available International Travel Options

- Airplane  Name of the Airport Shoa Rustaveli Tbilisi International Airport, Kutaisi International AIRPORT, Rize International Airport  
\_\_\_\_\_
- Train  Name of the Station \_\_\_\_\_
- Other  Details: \_\_\_\_\_  
\_\_\_\_\_  
\_\_\_\_\_

### 12.2 Category, Number and Prices of the Officially Selected Hotels

**THE CURRENCY ARE IN EUR**

Venue	Number of Hotels	Price P/P Single Room	Price P/P Double Room	Price P/P Breakfast
Hotel Category 1	3	150	180	
Hotel Category 2	3	140	170	
Hotel Category 3	3	130	160	
Hotel Category 4	3	100	130	
Hotel Category 5	3	75	130	
Other Accom.				

### 12.3 Distance between the Airport / Railway Station and Hotels

Venue	Distance (km)	Timing (hrs)
Hotel Category 1	10 km	



Hotel Category 2	10 km	
Hotel Category 3	12 km	
Hotel Category 4	13 km	
Hotel Category 5	15 km	
Other Accommod.		

**12.4 Distance between Hotels and Competition Venue**

Venue	Distance (km)	Timing (hrs)
Hotel Category 1	100 m	
Hotel Category 2	200m	
Hotel Category 3	1km	
Hotel Category 4	2km	
Hotel Category 5	5-7km	
Other Accommod.		

**12.5 Arrangement for Transportation of Delegations**

Transport Description	Bus	Mini-Bus	Shuttle	Other	Price
From Airport/ Station to Hotels	1				80 Euro
From Hotels to Competition Venues	1				Free
From Hotels to Training Venues	1				Free

**12.6 Arrangement for Transportation of Officials**

Transport Description	Bus	Mini-Bus	Shuttle	Other	Price
From Airport/ Station to Hotels	1				Free
From Hotels to Competition Venues	1				Free

**13. Publicity and Promotion**

What publicity and promotion methods you plan to use:

- Advertisements on Radio
- Advertisements on TV
- Press conferences
- Street Posters and Bans
- Dedicated website/social media
- Other

Present details of the publicity and promotion plan: \_\_\_\_\_

\_\_\_\_\_

\_\_\_\_\_

\_\_\_\_\_

---



---



---



---

**14. Tickets and Derived Products**

- How many tickets you expect to sell during the WC? 5000 \_\_\_\_\_
- What price of tickets you will apply? 20 GEL \_\_\_\_\_

**15. Press Coverage**

Press coverage of the World Championship must be in line with the FIE Press Handbook.

**Do you herewith confirm that you are committed to implement the FIE Press Handbook?** YES  NO

**16. Television Coverage**

TV coverage of the World Championship must be in line with the FIE Television Handbook.

**Do you herewith confirm that you are committed to implement the FIE Television Handbook?** YES  NO

**16.1 Details of the Television Coverage Plan**

- National TV Channels
  - Live Broadcast  Number of Hours: 10 \_\_\_\_\_
  - Recorded Broadcast  Number of Hours: 15 \_\_\_\_\_
- Regional TV Channels
  - Live Broadcast  Number of Hours: 8 \_\_\_\_\_
  - Recorded Broadcast  Number of Hours: 15 \_\_\_\_\_
  - Other

Present details of the TV Coverage plan: \_\_\_\_\_

---



---



---



---



---

**17. Marketing plan**

**17.1 Details of the Marketing Plan**

In our opinion a marketing plan is the advertising strategy that a business will implement to sell its product or service. The marketing plan will help determine who the target market is, how best to reach them, at what price point the product or service should be sold, and how the company will measure its efforts

So, The World Championship like all popular global events, is going to be a great opportunity for us. Millions of eyes and ears will all be in this one place. Use it to sell more and grow awareness.

*Podcast advertising is doing it better*

Benefits of podcast advertising for global events

We see a lot of brands turn to YouTube for advertising because its huge and popular! So of course the World Championship will trigger many to go there. But there is no way you can get a six-second YouTube ad to achieve anywhere near the same engagement and conversion rates as podcasts.

Add podcasts to our World Championship media plans

Podcasts are a strong medium by themselves but also completely complementary to all digital, social, print, TV, and OOH media. Data shows by adding audio to our media plans, consumers take more notice, have more trust, and are more likely to consider our product.

An example of this comes from Australian Radio Network's Neuro Lab. They found out-of-home and TV messages saw a 35% average increase in memory when paired with media running across audio channels. Why? Human brains are wired to retain audio messages. Our auditory memory lasts longer than visual memory. By creating a podcast ad you become more memorable and elicit stronger emotional responses. A great idea for World Championship marketing is to following the event in real-time. It adds story and relevance, and is less likely to be considered as straight advertising. If your marketing message follows a player, team, results etc. podcast ads are supportive of this. Creatives in programmatic podcast advertising, much like digital, can be instantly switched for immediate change. We can create a variety of ads ahead of time for fast changes or at Next Broadcast Media we have a team of voice talent and producers that can quickly turn around audio ads within hours.

**17.2 Date when the complete Marketing Plan will be submitted to the FIE \_\_\_\_\_**

**18. Sponsors**

**18.1 Sponsors Selection**

Organising Committee cannot approach or make sponsorship arrangements with any company that is competitor with the major FIE sponsors.

**Do you herewith confirm that you will comply with presented criteria for selection of the sponsors?** YES  NO

**Do you herewith confirm that you are committed to implement Requirements that are specified in the FIE Press Handbook and the FIE Handbook of Regulations for WC?** YES  NO

**18.2 Date when the complete List of Sponsors will be submitted to the FIE** \_\_\_\_\_

### **19. Protocol**

The protocol ceremonies must be organised as specified in the FIE Handbook of Regulations for the Organization of Protocol Ceremonies at FIE Competitions.

The FIE Chief of Protocol coordinates with the LOC Protocol Manager to ensure that all elements of FIE protocol are respected.

**Do you herewith confirm that Protocol will be organised according to this FIE document?** YES  NO

### **20. Medical Service**

Medical Service is to be provided in accordance for by the FIE Rules, the FIE Administrative Rules, the FIE Handbooks of Regulations and FIE Medical Handbook.

**Do you herewith confirm that you will comply organization of the Medical Service with the listed FIE Documents?** YES  NO

Medical Service is covering Medical Emergencies, Sports Trauma, General Medical Care and Additional Medical Services (Physiotherapy etc.).

Basic requirements are as follows

- Medical Stations, with locally licenced paramedic or doctor, must be present in competition halls, **MAXIMUM two (2) minutes away from the furthest hall**, and properly marked;
- Adequate ambulance must be present on site or **MAXIMUM at ten (10) minutes' drive distance**;
- Hospital with the emergency ward and facilities required for treatment of the possible injuries and illnesses must be selected and arrangements made for adequate support in case of emergency;

**Do you herewith confirm that you will meet Medical Service requirements?** YES  NO

### **21. Doping Control**

According to the FIE Anti-Doping Rules, Doping Control tests are obligatory at all World Championships.

Testing process must be strictly managed according to the WADA regulations.

Doping Control Office (DCO) must be supplied by the National Anti-Doping Organization (NADO).

Analysis of the samples must be performed by the IOC accredited laboratory. Coordinator of the doping control is the FIE Medical Delegate.

Doping Control station must be allocated as close as possible to the Finals venue, with all required facilities to accommodate limited access, privacy, preparation of the documentation, taking and processing samples.

Sample collection bottles, containers and forms are to be supplied the NADO.

**Do you herewith confirm that you will meet Doping Control requirements according to these regulations? YES  NO**

## 22. Security

The Organizing Committee has to organise Security and Safety Service in order to provide:

- The health and physical security of all the participants;
- Safety of all the installed equipment;
- Regulation of access to various sites of the competition in line with the applied accreditation;
- No unauthorised access of the pistes and official rooms by the public;
- Good and safe circulation of people;

Also, discreet police service and the presence of a fire service is to be planned.

**Do you herewith confirm that you will meet presented Security requirements? YES  NO**

## 23. Insurance

The Organising Committee must, at its own costs, institute:

- Liability Insurance policy which will include general liability coverage, as well as a guarantee for non-consecutive intangible damages (pure financial loss).
- All other mandatory insurance, such as:
  - ❖ Fire and fire damage insurance policies for premises necessary to the organisation
  - ❖ Automobile insurance policies (if necessary)
  - ❖ All policies mandated by local legislation.
- Repatriation Assistance coverage for the Fencing family, but without covering the designated officials or referees, the Executive Committee, or FIE personnel.

**Do you herewith confirm that you will meet presented Insurance requirements? YES  NO**

## 24. Rewards for the Winners

**YES  NO**

Present details of the planned Rewards for the Winners: The winning athletes will be awarded with medals. Negotiations are underway with sponsors to award cash prizes

## 25. Cultural Programme Plan

**YES  NO**

Present details of the Cultural Plan: \_\_\_\_\_

\_\_\_\_\_

**26. Environmental Protection Plan**

**YES**  **NO**

Present details of the Environmental Protection Plan: Cleanres, hanging signs

**TEA**

TEAPOT SELECTION "ALTHAUSE" black, green, jasmine, fruit	6.00
TEA "ALTHOUSE" teabag	5.00
TEA "BUETEA" Black, green, Cranberries	4.00

**COFFEE**

CAPPUCCINO	6.00
AMERICANO	6.00
LATTE	6.00
ESPRESSO	5.00
DOUBLE ESPRESSO	7.00
ORIENTAL COFFEE	5.00
ICED COFFEE	7.00
ICED COFFEE WITH ICE-CREAM	11.00

**SOFT DRINKS & JUICES**

BORJOMI SPARKLING MINERAL WATER	4.50
BAKURIANI SPRING STILL WATER	4.00
COCA-COLA, FANTA, SPRITE	4.00
LEMONADE "KAZBEGI"	4.00
ENERGY DRINK XL	10.50
HOMEMADE LEMONADE (1 L)	16.00
JUICE SELECTION "SANDORA"	6.00
JUICE SELECTION "CAMPA"	5.00
FRESHLY SQUEEZED JUICE orange, grapefruit, apple, carrot	11.00
DRIVE SAFE (50 ML)	22.00

**BEER**

BLACK LION IPA (0.5 L)	15.50
BLACK LION APA (0.5 L)	15.50
HEINEKEN (0.33 L)	10.50
ESTRELLA (0.33 L)	12.00
ERDINGER (0.33 L)	14.00
CORONA (0.335 L)	13.00
STELLA ARTOIS (0.33 L)	11.00
EFFES (0.5 L)	9.50
PILSNER URQUELL (0.5 L)	15.50

**VERMOUTH**

MARTINI EXTRA DRY (100 ML)	14.00
MARTINI (100 ML) Bianco / Rosso	14.00

**RUM**

CAPTAIN MORGAN (50 ML) White / Black / Spiced Gold	12.00
HAVANA CLUB 3 YEARS OLD (50 ML)	30.00
HAVANA CLUB 7 YEARS OLD (50 ML)	15.00
BACARDI (50 ML) Carta Blanca / Premium Black	13.00

**GIN**

GORDON'S (50 ML)	12.00
TANQUERAY TEN (50 ML)	25.00
BOMBAY SAPPHIRE (50 ML)	16.00
HENDRICK'S (50 ML)	25.00

**TEQUILA**

JOSE CUERVO (50 ML)	14.00
OLMECA (50 ML) White / Gold	14.00
DON JULIO REPOSADO (50 ML)	36.00
PATRON SILVER (50 ML)	37.00
DON JULIO BLANCO (50 ML)	34.00

**LIQUEUR**

BAILEYS (50 ML)	11.00
SHERIDAN'S (50 ML)	17.00
JAGERMEISTER (50 ML)	11.00
DRAMBUIE (50 ML)	14.00

**BLENDED WHISKY**

JOHNNIE WALKER BLACK LABEL (50 ML)	21.00
JOHNNIE WALKER BLUE LABEL (50 ML)	82.00
CHIVAS REGAL 12 Y/O (50 ML)	24.00
CHIVAS REGAL 18 Y/O (50 ML)	52.00

**SINGLE MALT WHISKY**

SINGLETON OF DUFFTOWN 12 Y/O (50 ML)	28.00
TALISKER 10 Y/O (50 ML)	38.00
GLENFIDDICH 12 Y/O (50 ML)	29.00
GLENMORANGIE ORIGINAL (50 ML)	29.00
LAPHROAIG 10 Y/O (50 ML)	40.50
MACALLAN 12Y DBL CSK (50 ML)	49.00
MACALLAN 15Y DBL CSK (50 ML)	62.00

**IRISH WHISKY**

JAMESON (50 ML)	14.00
MONKEY SHOULDER (50 ML)	20.00
BALVENIE DOUBLEWOOD 17 YEARS OLD (50 ML)	77.00
TULLAMORE DEW (50 ML)	14.00
REDBREAST 12 YEARS OLD (50 ML)	39.00
BUSHMILLS (50 ML)	19.00

**BOURBON / TENNESSEE**

BULLEIT KENTUCKY (50 ML)	23.00
JACK DANIEL'S (50 ML)	18.00
MAKER'S MARK (50 ML)	26.00
JIM BEAM (50 ML)	14.00
FOUR ROSES (50 ML)	15.00

**COGNAC**

HENNESSY V.S (50 ML)	26.00
HENNESSY V.S.O.P (50 ML)	43.00
HENNESSY X.O (50 ML)	97.00
REMY MARTIN V.S.O.P (50 ML)	41.00
REMY MARTIN X.O (50 ML)	89.00
COURVOISIER V.S.O.P (50 ML)	41.00
COURVOISIER V.S (50 ML)	27.00

**GEORGIAN BRANDY**

ASKANELI BROTHERS V.S.O.P (50 ML)	16.00
SARAJISHVILI V.S (50 ML)	11.00
SARAJISHVILI V.S.O.P (50 ML)	18.50
SARAJISHVILI X.O (50 ML)	36.00
SARAJISHVILI EXTRA (50 ML)	67.00
RTVELISI BRANDY V.S.O.P (50 ML)	17.00

**CHACHA**

TELIANI VALLEY CHACHA SILVER (50 ML / 0.5 L)	8.00 / 70.00
TELIANI VALLEY CHACHA GOLD (50 ML / 0.5 L)	9.00 / 80.00
CHACHA ASKANELI BROTHERS GOLD (50 ML / 0.5 L)	8.00 / 70.00
CHACHA ASKANELI BROTHERS PLATINUM (50 ML / 0.5 L)	8.00 / 70.00
CHATEAU MUKHRANI CHACHA (50 ML / 0.7 L)	15.00 / 178.00
GWS-CHACHA OAK (50 ML / 0.7 L)	11.00 / 130.00
RTVELISI CHACHA CLASSIC (50 ML / 0.5 L)	8.00 / 74.00
RTVELISI BARREL AGED CHACHA (50 ML / 0.5 L)	9.00 / 84.00

**VODKA**

BELVEDERE (0.5 L)	220.00
GREY GOOSE (0.5 L)	220.00
BELUGA (0.5 L)	220.00
ABSOLUT (50 ML / 0.5 L)	9.00 / 82.00
FINLANDIA (50 ML / 0.5 L)	8.00 / 74.00
STOLICHNAYA PREMIUM VODKA (50 ML / 0.5 L)	7.00 / 62.00
DANZKA (0.5 L)	75.00

**COLD DISHES**

CHEESE SULGUNI	0,125	8,50
CHEESE IMERULI	0,125	7,50
GEORGIAN CHEESE SELECTION	0,225	17,50
KAKHETIAN GUDA CHEESE	0,075	11,50
NADUGHI IN SULGUNI LAYER	0,075	6,00
GEBZHALIA	0,140	11,00
MKHALI PLATTER	0,175	11,50
EGGPLANT WITH WALNUTS	0,125	7,50
PICKLES - HOMEMADE SELECTION	0,250	5,50
ASSORTED VEGETABLES	0,250	8,00
VEGETABLES ASSORTMENT	0,175	5,50
FRIED CHICKEN WITH BLACKBERRY SAUCE	0,325	21,50
BOILED PIGLET	0,100	13,25
BOILED VEAL TONGUE	0,060	9,00
KUCHMACHI WITH WALNUTS	0,115	8,25
COLD CUT MEAT SELECTION	0,200	23,00
FISH SELECTION	0,112	49,50

**SALADS**

FRESH CUCUMBER AND TOMATO SALAD WITH GURULIAN HAZELNUT DRESSING	0,225	7,00
GEORGIAN SALAD	0,200	6,00
GEORGIAN SALAD WITH WALNUT	0,225	7,00
GREEN SALAD	0,100	7,00
CHICKEN LIVER SALAD	0,200	7,00
GEBZHALIA SALAD	0,225	11,00
BEEF TONGUE SALAD	0,112	8,50
CAESAR SALAD	0,175	10,50
CHICKEN SALAD	0,112	7,50
FRESH AJAPHSANDALI	0,225	8,00

**SOUPS**

SOUP "KHARCHO"	0,150	7,50
CHICKEN CHIKHIRTMA	0,125	7,00
VEGETABLE SOUP	0,125	6,00
FISH SOUP	0,125	9,75

**SEAFOOD**

SMOKED SALMON	0,065	22,00
PAN FRIED STURGEON WITH WALNUTS SAUCE	0,085	32,50
BOILED SALMON IN VINAGER	0,125	20,50
CHARCOAL GRILLED SALMON	0,100	24,00
CHARCOAL GRILLED TROUT	0,100	9,00
ROASTED TROUT IN POMEGRANATE SAUCE	0,100	10,50

**HOUSE PASTRY**

ROYAL KHACHAPURI	0,350	12,00
MENGRELIAN KHACHAPURI	0,300	10,50
IMERETIAN KHACHAPURI	0,275	9,00
LOBIANI	0,275	6,50
SPINACH PIE	0,225	8,00
OSETIAN KHABIDZGINA	0,225	7,50
KUBDARI	0,275	10,50
MCHADI	0,050	1,50
CHVISHTARI	0,125	3,50
GEORGIAN BREAD	0,085	1,50

**HOT DISHES**

KHINKALI	0,040	1,25
ADJARIAN CHIRBULI - EGGS AND A PECULIAR SOUCE WITH WALNUTS AND TOMATOES	0,200	8,00
FIELD MUSHROOM WITH SULGUNI CHEESE	0,125	9,00
OYSTER MUSHROOM ON A CLAY PAN - KETSI	0,190	7,50
OYSTER MUSHROOM OJAKHURI - POTATOES / ONIONS / GARLIC / HERBS	0,250	8,50
OYSTER MUSHROOM "KHARCHO" WITH ROASTED "GHOMI"	0,250	10,50
ROASTED CHICKEN WITH AJIKA	0,250	21,50
POT-FRIED CHICKEN	0,225	18,00
SHKMERULI - FRIED CHICKEN WITH MILK AND GARLIC SOUCE	0,250	21,50
ROASTED CHICKEN IN WHITE WINE SAUCE	0,350	21,50
CHICKEN LIVER ON A CLAY POT	0,200	7,00
APKHAZURA	0,125	12,50
IMERETIAN KUPATI	0,150	12,00
MEGRELIAN KUPATI	0,100	12,50
PORK "OJAKHURI"	0,325	12,00
VEAL OJAKHURI	0,325	13,00
KALMAKHA MUSHROOM "CHAKAPULI"	0,175	10,50
LAMB "CHAKAPULI"	0,175	17,00
VEAL CHAKAPULI	0,175	15,50
VEAL CHASHUSHULI	0,125	14,00
VEAL RIBS FRIED ON A CLAY POT WITH AJIKA SAUCE	0,150	16,50
KHARCHO WITH WALNUTS	0,175	19,00
DOLMA IN VINE LEAVES	0,125	9,00
SLOWCOOKED RED BEANS IN CLAY POT WITH PICKLES	0,250	7,50
BEEF TONGUE IN WHITE WINE SAUCE	0,125	11,00
LAMB "CHAKHRAKULI " WITH TOMATO	0,175	18,00
VEAL TUSHKHAPATI - SLOWCOOKED VEAL STUFFED WITH FRESH HERBS AND GARLIC	0,200	32,00
MEGRELIAN KUCHMACHI ON A CLAY POT	0,150	10,00

**CHARCOAL GRILLED**

CHICKEN SHASHLYK	0,100	7,50
PORK SHASHLYK	0,125	9,25
VEAL SHASHLYK	0,100	13,00
MIXED KEBAB	0,125	8,00
VEAL KEBAB	0,125	9,50
STURGEON SHASHLIK	0,075	30,00

**GARNISH**

FRIED POTATOES	0,200	4,25
HOMEMADE POTATOES WITH ONIONS	0,225	4,25
GRILLED VEGETABLES	0,150	6,50
SVANETIAN TASHMIJABI	0,100	8,00
CHINCHKOLIA AS WELL CHINCHOLIA FROM SAMEGRELO	0,175	5,50
ELARJI	0,150	6,00
GHOMI	0,125	2,50

**SAUCES**

BAZHE - WALNUT SAUCE	0,075	4,50
MEGRELIAN AJIKA	0,050	2,75
TKEMALI -WILD PLUM SAUCE	0,050	1,50
TOMATO SOUCE	0,050	1,50
NASHARABI	0,025	1,50

**DESSERT**

TRADITIONAL GEORGIAN SWEETS	0,150	9,50
SEASONAL FRUITS	0,850	14,00
SINORI - ADJARIAN WALNUT DESSERT	0,125	8,50
CHURCHKHELA	1,000	3,25
ROASTED GEORGIAN NUT	0,100	9,75
ICE-CREAM - VANILLA/CHOCOLATE	0,090	4,00
HONEY	0,100	3,00
HOMEMADE MARMELAD	0,100	3,00
CAKE OF THE DAY	1,000	7,00





**Letter of commitment**  
(On letterhead of the NF)

Letter of Commitment

The national federation of GEORGIA

hereby bidding to the organisation of the World Championships of FIE

- 1) Hereby confirms that it has full knowledge of all its obligations and financial obligations to organise an FIE World Championships
- 2) Hereby confirms that it is committed:
  - a) to respect and implement the FIE Statutes, including articles 1.2.4 and 1.2.5, the FIE Ethics and Safeguarding codes, the FIE rules, the FIE Administrative Rules, the FIE handbook of regulations, FIE Protocol handbook and any FIE rule in force.
  - b) to respect Its financial obligations
- 3) confirms that it has received from its national authorities a written agreement guaranteeing the granting of visas to all the participants of the member national federations of the FIE.

Date, place  
07.09.2023

Signature, stamp







**BID QUESTIONNAIRE**

**FOR ORGANISATION**

**OF THE JUNIOR AND CADET**

**FENCING WORLD CHAMPIONSHIPS**

## IMPORTANT INFORMATION FOR BIDDING FEDERATIONS

- ❖ The FIE assigns the organisation of the World Championships to the National Federation of the host city. This federation will create a World Championships Organising Committee, which, coordinating at all times with the National Federation, will, from its inception, communicate directly with the FIE, from whom it receives its instructions.
- ❖ The Organising Committee must comply with the Rules, Statutes, Administrative Rules and the Handbook of Regulations of the FIE from its inception up until its dissolution.
- ❖ The FIE retains the right of final say on all questions pertaining to the World Championships.
- ❖ The bid must be sent by the national federation and reach the FIE Head Office **three (3) years before** the date of organization of the World Championships, before the Congress. On this occasion the candidates will be announced.
- ❖ The complete file of candidature must reach the FIE Head Office before the 1<sup>st</sup> of September.
- ❖ The candidate federation will have to make a commitment, in front of the Congress, to respect the FIE Handbooks of regulations and its financial obligations. A signed protocol between the FIE and the organizing federation will state its perfect knowledge of its obligation
- ❖ The bid procedure has to take place according to the FIE statutes
- ❖ The Organising Federation must provide a written agreement from the Ministry of Foreign Affairs guaranteeing the granting of visas to all the participants of the member national federations of the FIE.
- ❖ As specified on the relevant articles of the questionnaire it is obligatory to present plans and dimensions of all the competition venues attached to this document.

**Do you herewith accept the presented FIE bidding rules, procedure and specified special requirements?      YES       NO**

## QUESTIONNAIRE

### 1. Name of the Bidding Federation

Brazilian Fencing Confederation

### 2. Bidding Event (tick the corresponding square)

- Junior and Cadet World Championship

### 3. Place and dates of the event

Place City / Town: Rio de Janeiro

Dates: From April 03rd To April 12<sup>th</sup>, 2026

### 4. Presentation of the City/Town

- Present map with marked position of competition venues, hotels, airport, train station etc.

#### MAP

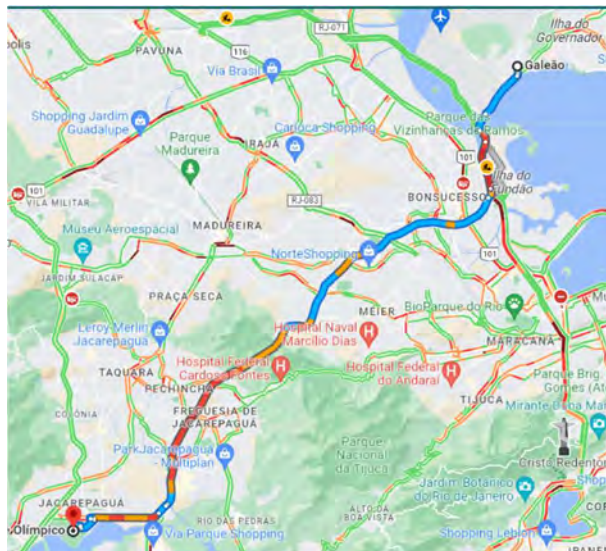

- City/Town details (Population, surface, climate, height etc.)  
Rio de Janeiro is one of the 27 federative units of Brazil. The estimated population in the municipality alone was 6,775,561 in 2021. It represents the second largest GDP in the country and the 30th largest in the world. Its coastline is 197 kilometers long and includes more than one hundred islands occupying 37 km<sup>2</sup>. It has a total area of 1 200.329 km<sup>2</sup>, with 6 775 561 inhabitants. Semi humid tropical climate, varying from 22 to 28°C in April, beginning of autumn
- Present the major fencing competitions or other sports tournaments already organized in this city/town  
2016 Olympic Games / Test Event 2016 / Women Epée World Cup 2010 – 2011 – 2015 – 2017 / Team World Championship 2016 / Epée Grand Prix 2016 / Pan American Games 2007

## 5. Composition of the Organising Committee

### 5.1 Organizing Committee Management

Title	Surname	Name	Contact Details
President	Machado	Ricardo	+55 51 98421-9695
Vice President	Schneider	Arno	+55 21 98040-1001
Secretary General	To be defined		
Treasurer	To be defined		

### 5.2 Organising Committee Important Portfolios

Portfolio	Surname	Name	Contact Details
Administration	To be defined		
Invitation of Participants	To be defined		
Invitation of Officials	To be defined		
Immigration and Visas	To be defined		
Entries and Accreditations	To be defined		
Technical Organization	To be defined		
Venue Renting	To be defined		
Telecommunications	To be defined		
IT Support	To be defined		
Safety and Security	To be defined		
Accommodation	To be defined		
Catering and Refreshments	To be defined		
Transportation	To be defined		
Technical Support	To be defined		
Maintenance	To be defined		
Publicity and Promotion	To be defined		
Press and Media Relations	To be defined		
Relations with Officials	To be defined		
Call Room Services	To be defined		
Equipment Control	To be defined		
Medical Service	To be defined		
Protocol	To be defined		
Sound System	To be defined		

## 6. Organising Committee Contact Details

Physical Address: Rua da Assembleia, 10 room 2012 – Centro –  
 Rio de Janeiro/RJ – Postal address: 20011-901  
 Tel.: +55 21 3289-0568  
 E-mail: contato@cbesgrima.org.br  
 Url: http:// www.cbesgrima.org.br  
 Mobile Phone: +55021098040-1001

## 7. Financing

The following is detailed Budget of the event, with specified sources of the Income and estimated Expenditures:

## 7.1 Income

Description	Amount (Currency)
Public Subventions	
• National	U\$ 200.000
• Regional	U\$ 50.000
• Local	U\$ 50.000
• Others	U\$ 200.000
Business Sponsors and Partners	U\$ 200.000
Private Sponsors and Donors	U\$ 50.000
Official providers	
Miscellaneous Sales	
• Tickets	0,00
• Rent of Stands	U\$ 10.000
• By-products	0,00
• Catering and Refreshments	U\$ 10.000
• TV Rights	U\$ 20.000
Other	
<b>Total</b>	<b>U\$ 790.000</b>

## 7.2 Expenditures

Description	Amount (Currency)
• Accommodation	USD 138.000,00
• Accreditation	USD 1.000,00
• Administrators	U\$ 0,00
• Air conditioning	U\$ 0,00
• Anti-doping service	U\$ 0,00
• Ceremonies and receptions	USD 3.000,00
• Cleaning	USD 10.000,00
• Computers, telephone, fax	USD 20.000,00
• Decoration	USD 9.000,00
• Electricity and water	U\$ 0,00
• Equipment	USD 3.600,00
• FIE guests, officials and VIP	USD 43.000,00
• Hostesses, Interpreters, Drivers etc....	USD 2.000,00
• Information/Public relations/Promotion:	USD 3.000,00
• Insurance	USD 5.000,00
• Medical service	USD 7.500,00
• Organising Committee	USD 42.600,00
• Officials	USD 42.000,00
• Other Expenses	USD 30.000,00
• Pistes and equipment specific to fencing	USD 10.000,00
• Promotion and Publicity	USD 5.000,00
• Referees	USD 81.500,00

• Results system	USD 1.500,00
• Security	USD 10.000,00
• Settings	USD 1.500,00
• Sound system, lights	USD 10.000,00
• Technicians	USD 3.000,00
• Transportation	USD 10.000,00
• Venues	USD 10.000,00
• Volunteers	USD 5.200,00
• Wireless	USD 3.000,00
<b>Total</b>	<b>USD 510.400,00</b>

### 8. Official Support Documents from the National and/or Local Authorities

Can you provide Official Support Documents from the National and/or Local Authorities (including visa guarantee letter)? YES  NO

If YES, these documents are to be listed and attached to this document.

Authority	Document
Brazilian Olympic Committee	letter of support for the competition
Municipal Sports and Leisure Secretariat	letter of support for the competition
Brazilian Fencing Confederation	Letter of Commitment
Visit Rio Convention Bureau	letter of support for the competition

### 9. Event Program

Detailed Program of the event will be submitted to the FIE Executive committee for approval.

Typical program of the Junior and Cadet World Championship is as follows:

DAY 1 - Friday		
Junior Women's Sabre	Pools - DE 64 - Final	Arena Carioca 1 e 2
Junior Men's Sabre	Pools - DE 64 - Final	Arena Carioca 1 e 2
DAY 2 - Saturday		
Cadet Women's Sabre	Pools - DE 64 - Final	Arena Carioca 1 e 2
Cadet Men's Sabre	Pools - DE 64 - Final	Arena Carioca 1 e 2
DAY 3 - Sunday		
Junior Women's Sabre Team	DE 64 - Final	Arena Carioca 1 e 2
Junior Men's Sabre Team	DE 64 - Final	Arena Carioca 1 e 2
DAY 4 - Monday		
Junior Women's Foil	Pools - DE 64 - Final	Arena Carioca 1 e 2
Junior Men's Foil	Pools - DE 64 - Final	Arena Carioca 1 e 2
<b>Opening Ceremony</b>		Arena Carioca 1
DAY 5 - Tuesday		
Cadet Women's Foil	Pools - DE 64 - Final	Arena Carioca 1 e 2
Cadet Men's Foil	Pools - DE 64 - Final	Arena Carioca 1 e 2
DAY 6 - Wednesday		
Junior Women's Foil Team	DE 64 - Final	Arena Carioca 1 e 2
Junior Men's Foil Team	DE 64 - Final	Arena Carioca 1 e 2



FIE Bid Questionnaire for Junior and cadet World Championships

DAY 7 – Thursday		
Junior Women's Epee	Pools - DE 64 - Final	Arena Carioca 1 e 2
Junior Men's Epee	Pools - DE 64 - Final	Arena Carioca 1 e 2
DAY 8 – Friday		
Cadet Women's Epee	Pools - DE 64 - Final	Arena Carioca 1 e 2
Cadet Men's Epee	Pools - DE 64 - Final	Arena Carioca 1 e 2
DAY 9 - Saturday		
Junior Women's Epee Team	DE 64 - Final	Arena Carioca 1 e 2
Junior Men's Epee Team	DE 64 - Final	Arena Carioca 1 e 2
Closing Ceremony		Arena Carioca 1

Do you herewith confirm that you will implement the presented Typical Program of the Junior and Cadet World Championship?

YES  NO

**10. Venue for the Competition**

Name of the Venue: Arena Carioca 1 and Arena Carioca 2

Address of the Venue: Avenida Embaixador Abelardo Buenos, s/nº - Barra da Tijuca/RJ

Number of the Available Halls: 2

Number of Halls to be Used: 2

**10.1 Allocation of the Selected Halls:**

**10.1.1 Preliminary Phase Halls**

- Number of Preliminary Phase Halls: 1
- Dimensions of each Hall: Arena Carioca 2 – 100m x 50m
- Number of Pistes at each Hall: 30
- Total Number of Pistes: 30
- Average Width of the Refereeing Zone: 3,5m<sup>2</sup> – 5m<sup>2</sup>

**DRAWINGS OF THE PRELIMINARY PHASE HALLS**

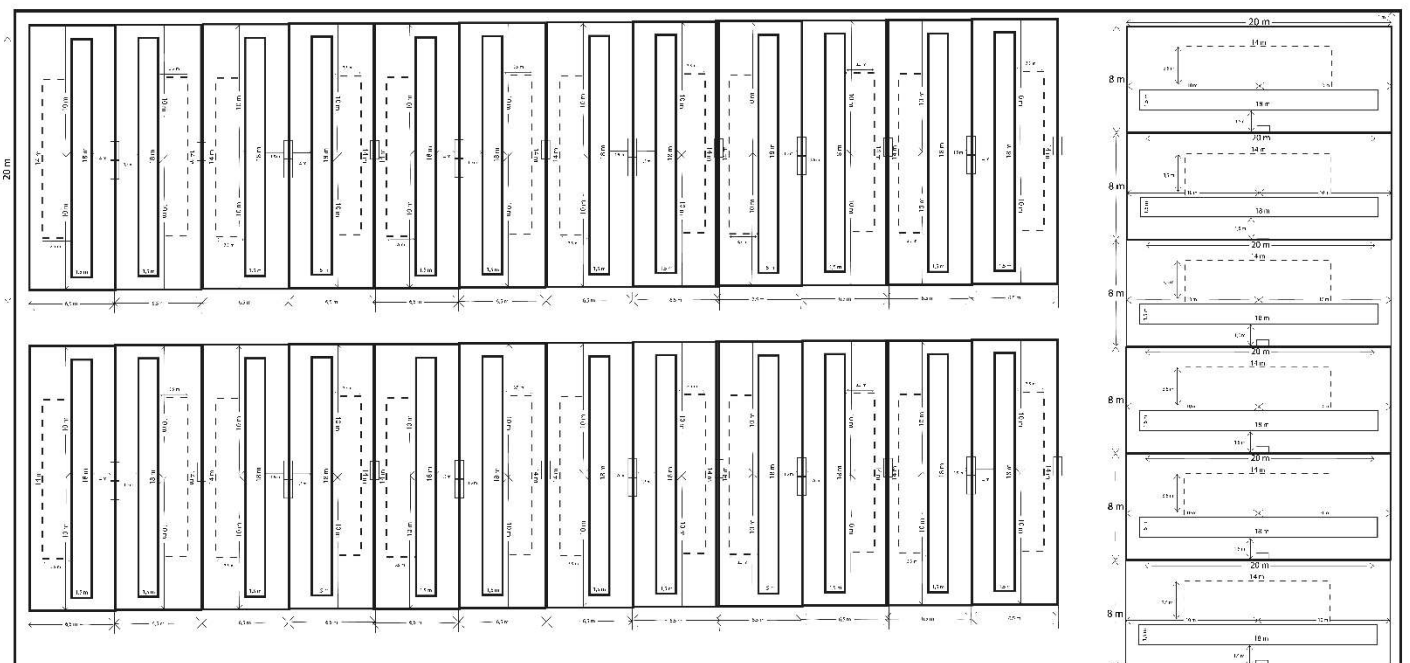

**10.1.2 Hall for the Direct Elimination**

- Dimensions of the Hall: 60m x 40m
- Eight (8) Coloured Pistes in different colours **YES**  **NO**
- Wireless System (optional) **YES**  **NO**
- Location for the Video-Refereeing Camera on the same side as the referee, outside of Refereeing zone **YES**  **NO**
- Video Refereeing Station on the same side as the referee, outside of refereeing zone **YES**  **NO**

**10.1.3 Hall for the Finals – Single Piste**

- Blue carpet on the entire square four (8) Coloured Pistes around podium (Final piste) **YES**  **NO**
- Dimensions of the Hall: 60m x 40m
- One (1) Piste 1.5m wide, 18m Lng **YES**  **NO**
- Piste on the podium 30 – 50cm raised, with lateral safety minimum 25cm and inclines at the end of the piste **YES**  **NO**
- Refereeing zone 4.0 – 4.5m from the piste **YES**  **NO**
- Wireless System (optional) **YES**  **NO**
- Location for the Video-Refereeing Camera on the same side as the referee, outside of Refereeing zone **YES**  **NO**
- Video Refereeing Station on the same side as the referee, outside of Refereeing zone (4.0m minimum) **YES**  **NO**
- Wireless Microphone for the Referees **YES**  **NO**

**10.1.4 Hall for the Direct Elimination and Finals with Single Piste and four (8) Coloured Pistes.**

- Blue carpet on the entire square four (8) Coloured Pistes and around podium (Final piste) **YES**  **NO**
- Dimensions of the Hall: 60m x 40m
- Four (8) Coloured Pistes in different colours **YES**  **NO**
- Wireless System (optional) **YES**  **NO**
- Location for the Video-Refereeing Camera on the same side as the referee, outside of Refereeing zone **YES**  **NO**
- Video Refereeing Station on the same side as the referee, outside of Refereeing zone **YES**  **NO**
- One (1) Final Piste 1.5m wide, 18m Long **YES**  **NO**
- Piste on the podium 30 – 50cm raised, with lateral safety minimum 25cm and inclines at the end of the piste **YES**  **NO**
- Refereeing zone 4.0 – 4.5m from the piste **YES**  **NO**
- Wireless System (optional) **YES**  **NO**
- Location for the Video-Refereeing Camera on the same side as the referee, outside of Refereeing zone **YES**  **NO**
- Video Refereeing Station on the same side as the referee, outside of Refereeing zone (4.0 m minimum) **YES**  **NO**
- Wireless Microphone for the Referees **YES**  **NO**

**DRAWINGS OF THE HALL FOR DIRECT ELIMINATION AND FINALS**

# FIE Bid Questionnaire for Junior and cadet World Championships

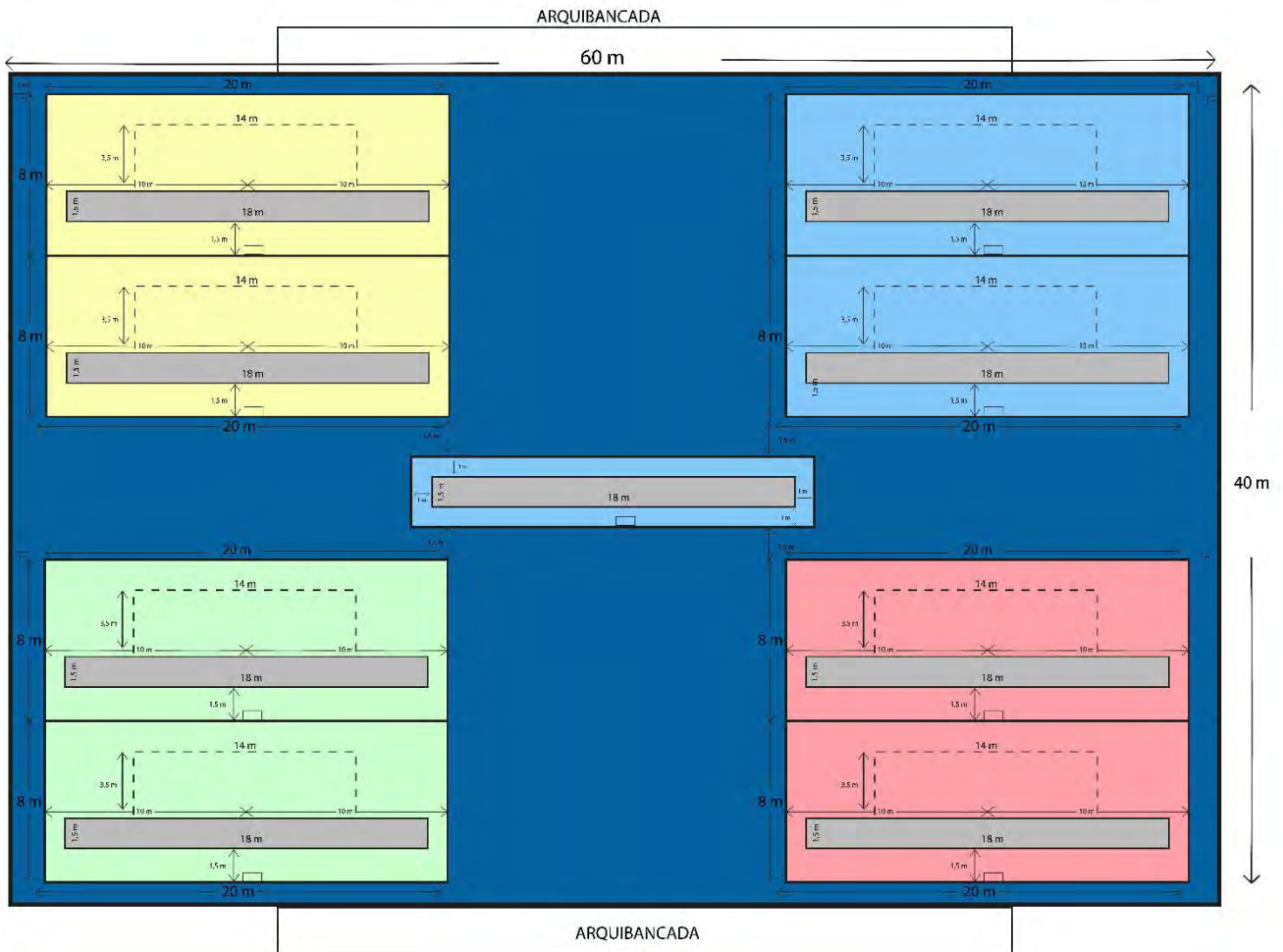

## 10.1.5 Training Halls

YES  NO

- Number of Training Halls: 2
- Dimensions of the Halls: 22m x 8m each one
- Total Number of Pistes: 8
- Total Number of Team boxes 80
- Team box dimensions (for National team) 3mx4m

## 10.1.6 Warm-up Halls

YES  NO

- Number of Warm-up Halls: 2
- 

## 10.2 Capacity of Spectators per Each Hall

Preliminary Phase Halls: 200  
 Hall for the Direct Elimination: 3.500  
 Hall for the Finals: 3.500

## 10.3 Rest rooms for the Athletes

YES  NO

- Number of Rest Rooms for Athletes: 1
- Dimensions of Rest Rooms: 10m x 20m

## 10.4 Rooms for Control of Weapons and Equipment

- Size of the selected room 400m<sup>2</sup> (Minimum 150m<sup>2</sup>.)
- Room must be operational and open 72 hours before the beginning of the first event. Is that realisable? **YES**  **NO**

#### 10.5 Office of Directoire Technique

- Size of the selected room 200 m<sup>2</sup> (Recommended 150-200m<sup>2</sup>.)
- Internet access and ADSL/Fiber Optic Line **YES**  **NO**
- Six (6) Tables of 2m length **YES**  **NO**
- Two (2) Computers for administration **YES**  **NO**
- Two (2) Computers with Printers **YES**  **NO**
- Reserve set of equipment (computers, printers, cartridges etc.) **YES**  **NO**
- One (1) High-performance Photocopier **YES**  **NO**
- Telephone Line and Telephone **YES**  **NO**
- Two (2) Wireless Microphones **YES**  **NO**
- Notice Board **YES**  **NO**

#### 10.6 Other rooms and halls (tick the existing)

- FIE Offices Size: 40m<sup>2</sup>
- President's office Size: 40m<sup>2</sup>
- Secretary General/Treasurer's office Size: 40m<sup>2</sup>
- FIE Meetings Room Size: 200m<sup>2</sup>
- OC Room Size: 200m<sup>2</sup>
- Referees Room (min 150m<sup>2</sup>) Size: 200m<sup>2</sup>
- Doping Control Station Size: 40m<sup>2</sup>
- Accreditation Room (min 100m<sup>2</sup>) Size: 200m<sup>2</sup>
- Information Centre Size: 200m<sup>2</sup>
- Press Centre (equipped) Size: 200m<sup>2</sup>
- Conference Room Size: 200m<sup>2</sup>
- FIE Stands (DYFG, Clean sport, Safe sport, others) Size: 40m<sup>2</sup>
- Fencing equipment suppliers Size: 200m<sup>2</sup>
- Other Size: 0

#### 10.7 Specification and Description of the Equipment available in Each Room

- For the offices rooms: Tables, chairs, multifunction printer, computers, electrical infrastructure, Wi-Fi, office supplies
- For the Conference room: auditorium seating, table of authorities, projection screen, electrical infrastructure, Wi-Fi, office supplies, wireless microphones
- For the Doping Control Station: room with bathroom, multifunction printer, cooler with ice/refrigerator, table and chairs
- For the Fencing equipment suppliers: an area will be set up for stands from the main suppliers of fencing material.

#### 10.8 Catering Facilities at the Venue

- Number of Restaurants 1
- Number of Snacks (Sandwiches and fast Food Service) 5
- Number of Drinks Sale Services 8
- Number of Tuck Shops 5

**10.9 Food and Refreshment Prices (Attach Price Lists)**

since in Brazil the prices of meals fluctuate according to the season, which is more natural, we can't define them in advance. We project the price of a complete meal, including protein, carbohydrates and fiber, is currently around 15 euros. However, we are negotiating with various suppliers, seeking to expand options that meet the dietary preferences of different cultures. In addition, there are a number of restaurants around the competition site

**10.10 Staff in the Venue**

- Professionals  Number: 50
- Volunteers  Number: 60

**11. Material and Equipment**

- a) Name of the supplier of fencing material and equipment for Weapon Control: Absolut / All Star
- b) List of equipment for weapon control: to be defined
- c) Name of the supplier of fencing material and equipment: for fencing halls Absolut / All Star
- d) Name of apparatus and reels (supplier/model): Favero / All Star
- e) Name of supplier of fencing pistes: Absolut / All Star
- f) Name of software for the management of the competitions: Ophardt / Fencing Time
- g) Name of the person in charge of computers in the OC: 6  
Number of computers for the management of the competitions: 6
- h) Name of the person in charge of computers in the OC: to be defined

**12. Accommodation and Transportation**

**12.1 Available International Travel Options**

- Airplane  Name of the Airport: Antonio Carlos Jobim International Airport / Santos Dumont National Airport
- Train  Name of the Station \_\_\_\_\_
- Other  Details: \_\_\_\_\_

**12.2 Category, Number and Prices of the Officially Selected Hotels**

Venue	Number of Hotels	Price P/P Single Room	Price P/P Double Room	Price P/P Breakfast
5-4 stars	1	100 euros	120 euros	included

4 stars	2	90 euros	110 euros	included
3-4 stars	3	80 euros	110 euros	included
3-4 stars	1	80 euros	110 euros	included

### 12.3 Distance between the Airport / Railway Station and Hotels

Venue	Distance (km)	Timing (hrs)
5-4 stars	15 km	1h20m
4 stars	15 km	1h20m
4 stars	15 km	1h20m
3-4 stars	15 km	1h20m
3-4 stars	15 km	1h20m
3-4 stars	15 km	1h20m
3-4 stars	15 km	1h20m

### 12.4 Distance between Hotels and Competition Venue

Venue	Distance (km)	Timing (hrs)
Hotel Category 1	2,5 km	8 minutes
Hotel Category 2	3 km	8 minutes
Hotel Category 3	2,5 km	8 minutes
Hotel Category 4	3 km	8 minutes
Hotel Category 5	2,4 km	8 minutes

### 12.5 Arrangement for Transportation of Delegations

Transport Description	Bus	Mini-Bus	Shuttle	Other	Price
From Airport/ Station to Hotels	5		5		under negotiation
From Hotels to Competition Venues	4		4		under negotiation
From Hotels to Training Venues	4				under negotiation

### 12.6 Arrangement for Transportation of Officials

Transport Description	Bus	Mini-Bus	Shuttle	Other	Price
From Airport/ Station to Hotels			8		under negotiation
From Hotels to Competition Venues			8		under negotiation

## 13. Publicity and Promotion

What publicity and promotion methods you plan to use:

- Advertisements on Radio
- Advertisements on TV

- Press conferences
- Street Posters and Bans
- Dedicated website/social media
- Other

Present details of the publicity and promotion plan:

- 5 adds of 15-second on radio stations 3 months before the competition.
- 5 adds of 15-second ads on local radio stations 1 month before the competition.
- Publicizing the event through a notice to federations, clubs, coaches, athletes and the general public
- Publication on the website and social networks - Facebook, Instagram, Twitter, Threads
- Campaign (ads) on social networks - Facebook and Instagram targeted at the target audience.
- Ads focusing on registration and an invitation to the event
- Broadcast of the competition on CBE's YouTube channel (CBEsgrima TV)

#### 14. Tickets and Derived Products

- How many tickets you expect to sell during the WC? 15.000
- What price of tickets you will apply? 0

#### 15. Press Coverage

Press coverage of the World Championship must be in line with the FIE Press Handbook.

**Do you herewith confirm that you are committed to implement the FIE Press Handbook?** YES  NO

#### 16. Television Coverage

TV coverage of the World Championship must be in line with the FIE Television Handbook.

**Do you herewith confirm that you are committed to implement the FIE Television Handbook?** YES  NO

##### 16.1 Details of the Television Coverage Plan

- National TV Channels
  - Live Broadcast  Number of Hours: under negotiation
  - Recorded Broadcast  Number of Hours: under negotiation
- Regional TV Channels
  - Live Broadcast  Number of Hours: under negotiation
  - Recorded Broadcast  Number of Hours: under negotiation
  - Other

Present details of the TV Coverage plan: CBE is negotiating with broadcasters about the possibility of broadcasting on a closed sports channel

## **17. Marketing plan**

### **17.1 Details of the Marketing Plan**

Announcement of calendar event

- a. Letter to federations, clubs, coaches, athletes and the general public
- b. Publication on the website

2) Publicizing an event by call for entries

- a. Letter to federations, clubs, coaches, athletes and the general public
- b. Publication on the website
- c. Publication on social networks - Facebook, Instagram, Twitter, Threads
- d. Campaign (ads) on social networks - Facebook and Instagram targeted to the target audience
  - i. Ads focused on making registrations
  - ii. Ads inviting people to the event

3) Publicizing the competition

- a. Posts on social networks - Facebook and Instagram
  - i. Pre-event: informs venue, times
  - ii. During the event: informs about the start of the event, photo galleries, reels,
  - iii. Post-event: post results and reels with competition highlights
  - iv. Broadcast of the competition on CBE's YouTube channel (CBEsgrima TV)

**17.2 Date when the complete Marketing Plan will be submitted to the FIE: June 2025**

## **18. Sponsors**

### **18.1 Sponsors Selection**

Organising Committee cannot approach or make sponsorship arrangements with any company that is competitor with the major FIE sponsors.

**Do you herewith confirm that you will comply with presented criteria for selection of the sponsors? YES  NO**

**Do you herewith confirm that you are committed to implement Requirements that are specified in the FIE Press Handbook and the FIE Handbook of Regulations for WC? YES  NO**

**18.2 Date when the complete List of Sponsors will be submitted to the FIE: December 2025**

## **19. Protocol**



The protocol ceremonies must be organised as specified in the FIE Handbook of Regulations for the Organization of Protocol Ceremonies at FIE Competitions.

The FIE Chief of Protocol coordinates with the LOC Protocol Manager to ensure that all elements of FIE protocol are respected.

**Do you herewith confirm that Protocol will be organised according to this FIE document?** YES  NO

## 20. Medical Service

Medical Service is to be provided in accordance for by the FIE Rules, the FIE Administrative Rules, the FIE Handbooks of Regulations and FIE Medical Handbook.

**Do you herewith confirm that you will comply organization of the Medical Service with the listed FIE Documents?** YES  NO

Medical Service is covering Medical Emergencies, Sports Trauma, General Medical Care and Additional Medical Services (Physiotherapy etc.).

Basic requirements are as follows

- Medical Stations, with locally licenced paramedic or doctor, must be present in competition halls, **MAXIMUM two (2) minutes away from the furthest hall**, and properly marked;
- Adequate ambulance must be present on site or **MAXIMUM at ten (10) minutes' drive distance**;
- Hospital with the emergency ward and facilities required for treatment of the possible injuries and illnesses must be selected and arrangements made for adequate support in case of emergency;

**Do you herewith confirm that you will meet Medical Service requirements?** YES  NO

## 21. Doping Control

According to the FIE Anti-Doping Rules, Doping Control tests are obligatory at all World Championships.

Testing process must be strictly managed according to the WADA regulations.

Doping Control Office (DCO) must be supplied by the National Anti-Doping Organization (NADO).

Analysis of the samples must be performed by the IOC accredited laboratory. Coordinator of the doping control is the FIE Medical Delegate.

Doping Control station must be allocated as close as possible to the Finals venue, with all required facilities to accommodate limited access, privacy, preparation of the documentation, taking and processing samples.

Sample collection bottles, containers and forms are to be supplied the NADO.

**Do you herewith confirm that you will meet Doping Control requirements according to these regulations?** YES  NO

## 22. Security

The Organizing Committee has to organise Security and Safety Service in order to provide:

- The health and physical security of all the participants.
- Safety of all the installed equipment.
- Regulation of access to various sites of the competition in line with the applied accreditation.
- No unauthorised access of the pistes and official rooms by the public.
- Good and safe circulation of people;

Also, discreet police service and the presence of a fire service is to be planned.

**Do you herewith confirm that you will meet presented Security requirements?**

**YES**  **NO**

### **23. Insurance**

The Organising Committee must, at its own costs, institute:

- Liability Insurance policy which will include general liability coverage, as well as a guarantee for non-consecutive intangible damages (pure financial loss).
- All other mandatory insurance, such as:
  - ❖ Fire and fire damage insurance policies for premises necessary to the organisation
  - ❖ Automobile insurance policies (if necessary)
  - ❖ All policies mandated by local legislation.
- Repatriation Assistance coverage for the Fencing family, but without covering the designated officials or referees, the Executive Committee, or FIE personnel.

**Do you herewith confirm that you will meet presented Insurance requirements?**

**YES**  **NO**

### **24. Rewards for the Winners**

**YES**  **NO**

Present details of the planned Rewards for the Winners: We are negotiating with a company that makes Brazilian-themed slippers.

### **25. Cultural Programme Plan**

**YES**  **NO**

Present details of the Cultural Plan: Tours of cultural sports centers such as the Maracanã and São Januário stadiums will be planned, as well as a tour of the beaches of Rio de Janeiro

### **26. Environmental Protection Plan**

**YES**  **NO**

Present details of the Environmental Protection Plan:

- The Olympic Park, where the World Championship will be held, has been designed with environmental protection in mind, with recycling actions, environmental development and protection of its surroundings.
- Digital bulletin formats will be used during the competition, avoiding the use of paper.
- a reduced fleet of vehicles will be used to provide efficient transportation, while avoiding unnecessary vehicles on the streets
- The hotels chosen are just a few kilometers from the training and competition venues, which generates less vehicle traffic



To  
**International Fencing Federation**

## **STATEMENT**

The **BRAZIL OLYMPIC COMMITTEE** (COB) declares that the Brazilian Fencing Confederation (CBE), one of our affiliates, has the exclusive rights to rule, promote and develop any activities related to this sport within national territory, organizing and participating in events and official competitions, besides representing Brazil internationally.

Therefore, we are certain that CBE is well-qualified to apply for the holding of World Fencing Championship Junior and Cadet 2026, to be held from April 10 to 19 April.

Rio de Janeiro, September 1<sup>st</sup>, 2023.

Paulo Wanderley Teixeira  
President

**VISA FACILITIES STATEMENT**

The Brazilian Fencing Confederation declares that it will grant facilities for acquiring an entry visa to Brazil for participants registered and called for the 2026 Junior and Cadet World Championships, to be held in the city of Rio de Janeiro, from April 10 to 19, 2026.

Rio de Janeiro September, 11th, 2023

Sincerely Yours,

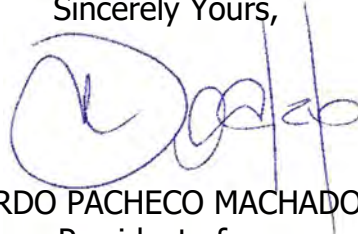

**RICARDO PACHECO MACHADO**  
President of  
Brazilian Fencing Confederation



Rio de Janeiro, 01 de Setembro de 2023.

Ilmo.

**Dr. Ricardo Pacheco Machado**

**Presidente da Confederação Brasileira de Esgrima**

**Ref.: Mundial Cadete Juvenil de Esgrima 2026**

Prezado Dr. Ricardo Pacheco Machado,

Foi com grande satisfação que tomamos conhecimento de que a Confederação Brasileira de Esgrima está considerando a possibilidade de realizar o **Mundial Cadete Juvenil de Esgrima 2026** na cidade do Rio de Janeiro. O Visit Rio Convention Bureau, representando toda a indústria turística da nossa cidade, se sentirá extremamente honrado caso a cidade seja escolhida para sediar o evento.

O Rio de Janeiro é uma cidade cosmopolita com quase de 7 milhões de habitantes. Seu Aeroporto Internacional, porta de entrada do Brasil para os principais países do mundo, opera com 22 companhias aéreas de todo o mundo e possui voos diretos para as principais capitais brasileiras. Além disso, conta com uma vasta rede hoteleira com aproximadamente 42.500 mil quartos, de diversas categorias.

Objetivando atender ao número cada vez maior de eventos esportivos, o Rio oferece inúmeras possibilidades de equipamentos do legado olímpico, incluindo o Parque Olímpico da Barra da Tijuca que possui arenas esportivas permanentes. A cidade oferece também segurança especial para congressos e eventos que estejam sendo realizados na cidade. O Visit Rio trabalha em parceria com o Centro de Operações Rio (COR) e o Batalhão de Policiamento em Áreas Turísticas (BPTUR), além das Secretarias de Turismo, municipal e estadual, dentre outros órgãos públicos.

Com serviços qualificados, profissionais experientes e toda infraestrutura adequada e necessária, o Rio de Janeiro é um destino ideal para a realização de eventos, onde os visitantes também poderão desfrutar da exuberante beleza natural e arquitetônica, importantes patrimônios culturais, diversidade culinária ímpar, além da hospitalidade única dos cariocas.

O Visit Rio Convention Bureau desde já oferece seu apoio institucional para que este evento se realize em nossa cidade e que seja um grande sucesso.

Atenciosamente,



Carlos Werneck

Presidente Executivo

**LETTER OF COMMITMENT**

The national federation of Brasil

- 1) Hereby confirms that it has full knowledge of all its obligations and financial obligations to organize an FIE World Championships
- 2) Hereby confirms that it is committed:
  - a) to respect and implement the FIE Statutes, including articles 1.2.4 and 1.2.5, the FIE Ethics and Safeguarding codes, the FIE rules, the FIE Administrative Rules, the FIE handbook of regulations, FIE Protocol handbook and any FIE rule in force.
  - b) to respect Its financial obligations
- 3) Confirms that it has received from its national authorities a written agreement guaranteeing the granting of visas to all the participants of the member national federations of the FIE

Rio de Janeiro September, 11th, 2023

Sincerely Yours,



**RICARDO PACHECO MACHADO**  
President of  
Brazilian Fencing Confederation





**BID QUESTIONNAIRE**

**FOR ORGANISATION**

**OF THE JUNIOR AND CADET**

**FENCING WORLD CHAMPIONSHIPS**

**2023**

## IMPORTANT INFORMATION FOR BIDDING FEDERATIONS

- ❖ The FIE assigns the organisation of the World Championships to the National Federation of the host city. This federation will create a World Championships Organising Committee, which, coordinating at all times with the National Federation, will, from its inception, communicate directly with the FIE, from whom it receives its instructions.
- ❖ FIE World Championships and other official FIE events are only assigned to National Member Federations who ensure free access to competitors and officials and whose Organizing Committees commit to send invitations to all the Federations having the right to take part, and who do everything in their power to obtain the visas needed.
- ❖ The Organising Committee must comply with all the FIE Rules, Statutes, Administrative Rules and the Handbook of Regulations of the FIE from its inception up until its dissolution. The member Federation which applies as a candidate to organise congresses, official competitions, or any other FIE international events will document that the organizer will use all means to enable all the member Federations to take part in those events, without any discrimination whatever.
- ❖ The FIE retains the right of final say on all questions pertaining to the World Championships.
- ❖ The bid must be sent by the national federation and reach the FIE Head Office **three (3) years before** the date of organization of the World Championships, before the Congress. On this occasion the candidates will be announced.
- ❖ The complete file of candidature must reach the FIE Head Office before the 1<sup>st</sup> of September.
- ❖ The candidate federation will have to make a commitment, in front of the Congress, to respect the FIE Handbooks of regulations and its financial obligations. A signed protocol between the FIE and the organizing federation will state its perfect knowledge of its obligation
- ❖ The bid procedure has to take place according to the FIE statutes
- ❖ The Organising Federation must provide a written agreement from the Ministry of Foreign Affairs guaranteeing the granting of visas to all the participants of the member national federations of the FIE.
- ❖ As specified on the relevant articles of the questionnaire it is obligatory to present plans and dimensions of all the competition venues attached to this document.

**Do you herewith accept the presented FIE bidding rules, procedure and specified special requirements?** YES  NO



## QUESTIONNAIRE

1. **Name of the Bidding Federation**

FENCING FEDERATION OF UZBEKISTAN

2. **Bidding Event (tick the corresponding square)**

- Junior and Cadet World Championship

3. **Place and dates of the event**

Place City / Town: TASHKENT

Dates: From 01/04 To 10/ 04 Year 2026

4. **Presentation of the City/Town**

- Present map with marked position of competition venues, hotels, airport, train station etc.

**MAP**

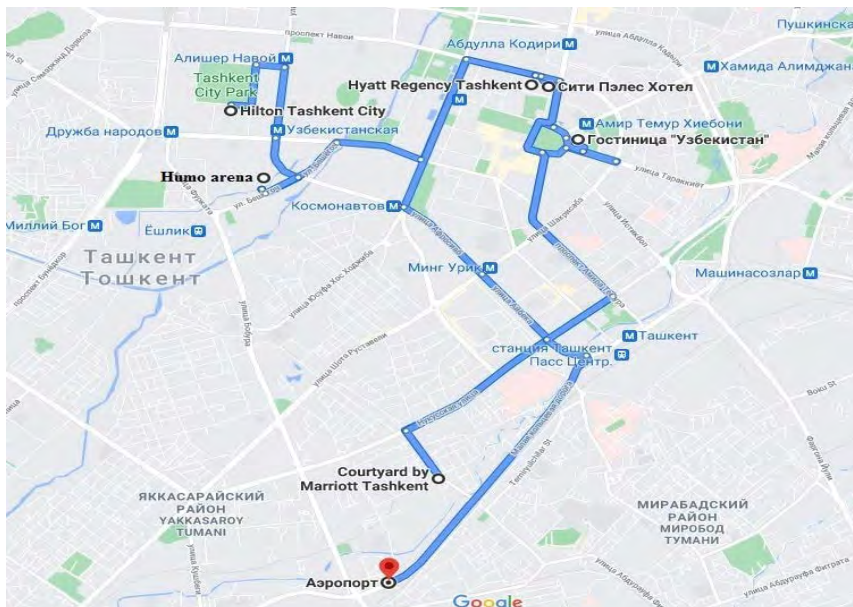

- City/Town details (Population, surface, climate, height etc.)
- City/Town details (Population, surface, climate, height etc.)  
Multi-faceted and fascinating Uzbekistan. It is situated in the very heart of Asia, at the intersection of trade routes of the legendary Great Silk Road.

The population of the Republic of Uzbekistan is more than 32 million people; the majority are Uzbeks (80%). There are about 100 Nations and nationalities.



Tashkent is the capital of Uzbekistan and is a metropolis. The history of Tashkent totals more than 2500 years.

Geographic coordinates – 41 ° 18'00 "N 69 ° 16'00" E

Territory – 334.8 km<sup>2</sup>

Population – more than 2 500 million

Altitude – 475 m

Tashkent, is the large economic, political, scientific and cultural center of Central Asia. The city is set out as a grid of straight, wide streets and avenues, interspersed with many green areas (parks, squares, and gardens) and fountains.

The climate is extremely continental. The average January temperature is +3 +10 °C, in July from +35°C. Autumn in Uzbekistan is as warm as spring. The average annual rainfall does not exceed 200-300 mm.



Flying is the most convenient way to get to Tashkent from other countries. The city is served by several international airlines, such as Aeroflot, Air Astana, Asiana Airlines, China Southern Airlines, Korean Airlines, Nordwind Airlines, Somon Air, and Turkish Airlines. The national airline, Uzbekistan Airways, offers regular flights to many European, Asian, and North American cities including Bangkok, Beijing, Delhi, Frankfurt, Istanbul, Kuala Lumpur, London, New York, Paris, Seoul, and Tel Aviv. It also flies to many CIS countries, as well as within Uzbekistan.

Although most international visitors arrive by air, Tashkent can also be reached by train from Russia or Kazakhstan. Trains are mainly used for travel within Uzbekistan, with regular trains between Tashkent and Samarkand, Bukhara, Urgench, Nukus, and other cities.

- Present the major fencing competitions or other sports tournaments already organized in this city/town

- In 2015 in Tashkent city was successfully organized Juniors & Cadets Fencing World Championship. From 2018 every year have been organizing Junior Sabre World Cup, Epee Satellite, Foil Satellite. Successfully organized in 2022, 2023 Junior and Cadets Asian Fencing Championships. In 2022 organized Juniors World Cups for foil and epee.

## 5. Composition of the Organising Committee

### 5.1 Organizing Committee Management

Title	Surname	Name	Contact Details
President	Abdusamadov	Makhsud	
Vice President			
Secretary General	Saidova	Gulnora	998977470430
Treasurer	Ablakulova	Nigora	998909807861

### 5.2 Organising Committee Important Portfolios

Portfolio	Surname	Name	Contact Details
Administration	Saidova	Gulnora	+998977470430
Invitation of Participants	Sharipov	Khalil	+998974331498
Invitation of Officials	Boybekova	Ozoda	+998909320265
Immigration and Visas	Rakhimova	Natalya	+998973426880
Entries and Accreditations	Sokolova	Nadejda	+998935309511
Technical Organization	Buriev	Ortik	+998946573493
Venue Renting	Zorkiov	Khayot	+998998988104
Telecommunications	Merzlyakov	Nikolay	998909306240
IT Support	Merzlyakov	Aleksandr	998909731511
Safety and Security	Zorkiov	Khayot	+998998988104
Accommodation	Silchenko	Vadim	998977470630
Catering and Refreshments	Zorkiov	Khayot	+998998988104
Transportation	Silchenko	Vadim	998977470630
Technical Support	Nugumanov	Donier	998911908131
Maintenance	Khodjimetov	Aziz	998935698240
Publicity and Promotion	Yakubova	Muborak	+998909187024
Press and Media Relations	Yakubova	Muborak	+998909187024
Relations with Officials	Saidova	Gulnora	+998977470430
Call Room Services	Usmonova	Zaynab	998911908131
Equipment Control	Nugumanov	Donier	998911908131
Medical Service	Musaev	Mamur	+998977730243
Protocol	Mamedova	Liya	998974040924
Sound System	Khodjimetov	Aziz	998935698240

## 6. Organising Committee Contact Details

Physical Address: Islam Karimov 98 A, Tashkent, Uzbekistan

Postal address: Islam Karimov 98 A, Tashkent, Uzbekistan

Tel.: +99871 241 18 55 Fax: .: +99871 241 18 55

E-mail: uzb.fencing@gmail.com

Mobile Phone: +998977470430

## 7. **Financing**

The following is detailed Budget of the event, with specified sources of the Income and estimated Expenditures:

### 7.1 Income

Description	Amount (USD)
Public Subventions	
• National	650 000 USD
• Regional	70 000 USD
• Local	20 000 USD
• Others	70 000 USD
Business Sponsors and Partners	270 000 USD
Private Sponsors and Donors	345 000 USD
Official providers	13 000 USD
Miscellaneous Sales	
• Tickets	
• Rent of Stands	
• By-products	
• Catering and Refreshments	
• TV Rights	
Other	
<b>Total</b>	<b>1 438 000 \$</b>

### 7.2 Expenditures

Description	Amount (USD)
• Accommodation (referees , technical directors,officials with full meals – 68 persons)	110 000 \$
• Accreditation	3 000 \$
• Administrators	10 000 \$
• Air conditioning	5 000 \$
• Anti-doping service	20 000 \$
• Ceremonies and receptions	55 000 \$
• Cleaning	3 000 \$
• Computering, telephone, fax	10 000 \$

• Decoration	35 000 \$
• Electricity and water	3 500 \$
• Equipment (carpet, changing cabins for each county, barriers and other )	70 000 \$
• FIE guests, officials and VIP	25 000 \$
• Hostesses, Interpreters, Drivers etc....	4 500 \$
• Information/Public relations/Promotion:	5 200 \$
• Insurance	10 000 \$
• Medical service	3 000 \$
• Organising Committee	15 000 \$
• Officials (salary of technical directorate 28 persons.)	80 000 \$
• Other Expenses	65 800 \$
• Pistes and equipment specific to fencing (30 completes )	150 000 \$
• Promotion and Publicity	4 500 \$
• Referees (Salary 46 pers., transport from/to home – 38 persons)	125 617 \$
• Results system	6 000 \$
• Security	5 000 \$
• Settings	10 000 \$
• Sound system, lights	85 000 \$
• Technicians	3 500 \$
• Transportation (flight tickets (technical directorate, referees - 68 persons), local transport during event)	245 000 \$
• Venues Renting Sport complex "Humo"	220 000 \$
• Volunteers	5 000 \$
• Wireless	1 500 \$
<b>Total</b>	<b>1 425 917 \$</b>

**8. Official Support Documents from the National and/or Local Authorities**

**Can you provide Official Support Documents from the National and/or Local Authorities (including visa guarantee letter)?** YES  NO

If YES, these documents are to be listed and attached to this document.

Authority	Document
Ministry of Youth Policy and sport of Uzbekistan	Letter supporting

**9. Event Program**

Detailed Program of the event will be submitted to the FIE Executive committee for approval.

Typical program of the Junior and Cadet World Championship is as follows:

<b>DAY 1 - Friday</b>		
Junior Women's Sabre	Pools - DE 64 - Final	HALLS _____
Junior Men's Sabre	Pools - DE 64 - Final	HALLS _____
<b>DAY 2 - Saturday</b>		
Cadet Women's Sabre	Pools - DE 64 - Final	HALLS _____
Cadet Men's Sabre	Pools - DE 64 - Final	HALLS _____
<b>DAY 3 - Sunday</b>		
Junior Women's Sabre Team	DE 64 - Final	HALLS _____
Junior Men's Sabre Team	DE 64 - Final	HALLS _____
<b>DAY 4 - Monday</b>		
Junior Women's Foil	Pools - DE 64 - Final	HALLS _____
Junior Men's Foil	Pools - DE 64 - Final	HALLS _____
<b>Opening Ceremony</b>		HALLS _____
<b>DAY 5 - Tuesday</b>		
Cadet Women's Foil	Pools - DE 64 - Final	HALLS _____
Cadet Men's Foil	Pools - DE 64 - Final	HALLS _____
<b>DAY 6 - Wednesday</b>		
Junior Women's Foil Team	DE 64 - Final	HALLS _____
Junior Men's Foil Team	DE 64 - Final	HALLS _____
<b>DAY 7 - Thursday</b>		
Junior Women's Epee	Pools - DE 64 - Final	HALLS _____
Junior Men's Epee	Pools - DE 64 - Final	HALLS _____
<b>DAY 8 - Friday</b>		
Cadet Women's Epee	Pools - DE 64 - Final	HALLS _____
Cadet Men's Epee	Pools - DE 64 - Final	HALLS _____
<b>DAY 9 - Saturday</b>		
Junior Women's Epee Team	DE 64 - Final	HALLS _____
Junior Men's Epee Team	DE 64 - Final	HALLS _____
<b>Closing Ceremony</b>		HALL _____

**Do you herewith confirm that you will implement the presented Typical Program of the Junior and Cadet World Championship?**

YES  NO

**10. Venue for the Competition**

Name of the Venue: Universal Sport Complex "HUMO ARENA"

<https://humoarena.com/>

Address of the Venue: Afrosiab – Besh-Egoch strs,

Number of the Available Halls: Main Hall- Field size: 30mx60 m (could be transformation to 28x60 and 26x60). There is Second Hall 30x 60 m. and third hall 25 x 50m



Number of Halls to be Used: Could be used three Halls

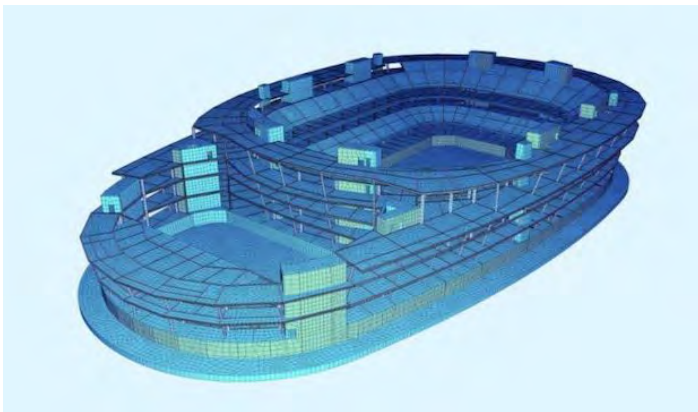

## 10.1 Allocation of the Selected Halls:

### 10.1.1 Preliminary Phase Halls

- Number of Preliminary Phase Halls: 2 Halls
- Dimensions of each Hall: Hall 2 30 m x 60 m, Hall 3 - 25m x 50m.
- For preliminary competitions – 30m x 60m. 25 x 50 m
- Number of Pistes at each Hall: Hall 1 - 5 pistes, Second (preliminary) Hall 2 - 16 pistes, Hall 3- 8 pistes
- Total Number of Pistes: 30 pistes
- Average Width of the Refereeing Zone: in Main Hall from 3, 5 m according FIE handbook  
Second Hall for preliminary competitions 3,5 m.

## DRAWINGS OF THE PRELIMINARY PHASE HALLS

Hall № 2

Hall № 3

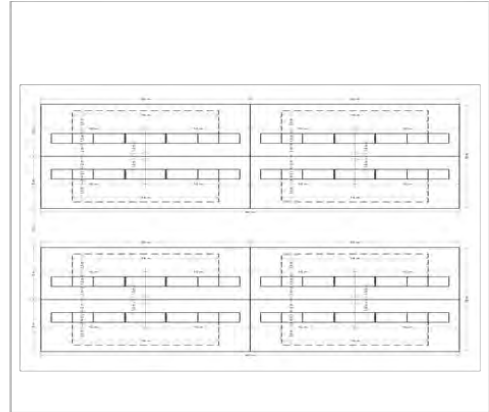
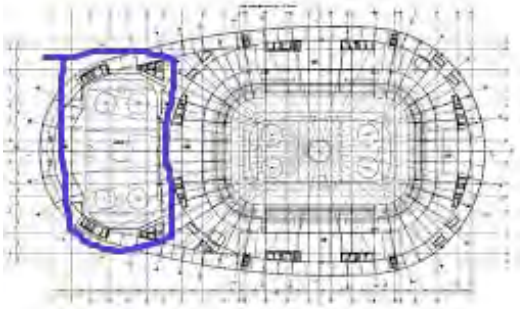

**10.1.2 Hall for the Direct Elimination**

- Dimensions of the Hall: 28 mx60m
- Four (4) Coloured Pistes in different colours **YES**  **NO**
- Wireless System (optional) **YES**  **NO**
- Location for the Video-Refereeing Camera on the same side as the referee, outside of Refereeing zone **YES**  **NO**
- Video Refereeing Station on the same side as the referee, outside of refereeing zone **YES**  **NO**

**DRAWING OF THE HALL FOR DIRECT ELIMINATION**

**10.1.3 Hall for the Finals – Single Piste**

**YES**  **NO**

- Blue carpet on the entire square four (4) Coloured Pistes around podium

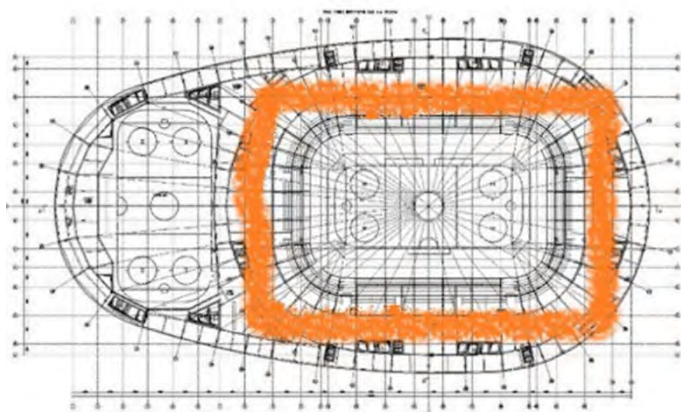

- (Final piste) **YES**  **NO**
- One (1) Piste 1.5m to 2m wide, 18m Lng **YES**  **NO**
- Piste on the podium 30 – 50cm raised, with lateral safety minimum 25cm and inclines at the end of the piste **YES**  **NO**
- Refereeing zone 4.0 – 4.5m from the piste **YES**  **NO**



- Wireless System (optional) YES  NO
- Location for the Video-Refereeing Camera on the same side as the referee, outside of Refereeing zone YES  NO
- Video Refereeing Station on the same side as the referee, outside of Refereeing zone (4.0m minimum) YES  NO
- Wireless Microphone for the Referees YES  NO

### DRAWING OF THE HALL FOR FINALS

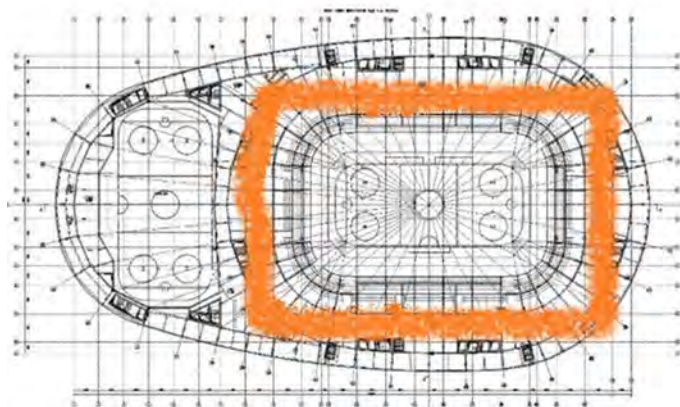

#### 10.1.4 Hall for the Direct Elimination and Finals with Single Piste and four (4) Coloured Pistes.

- |  |   |                             |
|--|---|-----------------------------|
|  | YES <input checked="" type="checkbox"/> | NO <input type="checkbox"/> |
|--|---|-----------------------------|
- Blue carpet on the entire square four (4) Coloured Pistes and around podium (Final piste) YES  NO
  - Dimensions of the Hall: \_\_\_\_\_
  - Four (4) Coloured Pistes in different colours YES  NO
  - Wireless System (optional) YES  NO
  - Location for the Video-Refereeing Camera on the same side as the referee, outside of Refereeing zone YES  NO
  - Video Refereeing Station on the same side as the referee, outside of Refereeing zone YES  NO
  - One (1) Final Piste 1.5m to 2m wide, 18m Long YES  NO
  - Piste on the podium 30 – 50cm raised, with lateral safety minimum 25cm and inclines at the end of the piste YES  NO
  - Refereeing zone 4.0 – 4.5m from the piste YES  NO
  - Wireless System (optional) YES  NO
  - Location for the Video-Refereeing Camera on the same side as the referee, outside of Refereeing zone YES  NO
  - Video Refereeing Station on the same side as the referee, outside of Refereeing zone (4.0 m minimum) YES  NO
  - Wireless Microphone for the Referees YES  NO

**DRAWINGS OF THE HALL FOR DIRECT ELIMINATION AND FINALS**

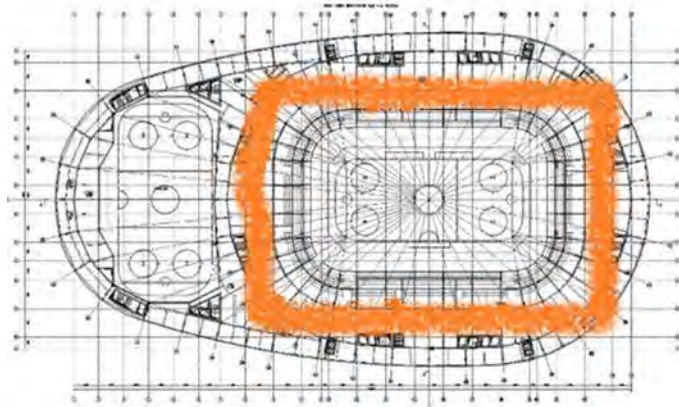

**10.1.5 Training Halls**

YES  NO

- Number of Training Halls: 1
- Total Number of Pistes: 10
- Total Number of Team boxes according confirmation of the participants - from 100 boxes
- Team box dimensions (for National team) 3mx4m according confirmation of the teams

**10.1.6 Warm-up Halls**

YES  NO

- Number of Warm-up Halls: 2

**10.2 Capacity of Spectators per Each Hall**

Preliminary Phase Halls: Yes – 300 seats  
 Hall for the Direct Elimination: Yes – 300 seats  
 Hall for the Finals: Yes – 14 000 seats

**10.3 Rest rooms for the Athletes**

YES  NO

- Number of Rest Rooms for Athletes: 8
- Dimensions of Rest Rooms: min 8x10m

**10.4 Rooms for Control of Weapons and Equipment**

- Size of the selected room \_160 m2 -
- 4 control stations will be installed in each call room of at least 120m<sup>2</sup>
- Room must be operational and open 72 hours before the beginning of the first event. Is that realisable? YES  NO

Weapon control will take place in three stages during the competition, to comply with the FIE Rules as follows (article o.28):

- general weapon control before the competition.
- verification during the pools and preliminary rounds of direct elimination.
- further verification before each bout of the table of 64 and of the final.

### 10.5 Office of Directoire Technique

- Size of the selected room 200 m<sup>2</sup> (Recommended 150-200m<sup>2</sup>)
- Internet access and ADSL/Fiber Optic Line **YES**  **NO**
- Six (6) Tables of 2m length **YES**  **NO**
- Two (2) Computers for administration **YES**  **NO**
- Two (2) Computers with Printers **YES**  **NO**
- Reserve set of equipment (computers, printers, cartridges etc.) **YES**  **NO**
- One (1) High-performance Photocopier **YES**  **NO**
- Telephone Line and Telephone **YES**  **NO**
- Two (2) Wireless Microphones **YES**  **NO**
- Notice Board **YES**  **NO**

### 10.6 Other rooms and halls (tick the existing)

- x FIE Offices Size: 60m2
- President's office Size: 60m2
- Secretary General/Treasurer's office Size: 40m2
- FIE Meetings Room Size: 70m2
- OC Room Size: 50m2
- Referees Room (min 150m2) Size: 150m2
- Doping Control Station Size: 50m2
- Accreditation Room (min 100m2) Size: 140m2
- Information Centre Size: 70m2
- Press Centre (equipped) Size: 70m2
- Conference Room Size: 100m2
- FIE Stands (DYFG, Clean sport, Safe sport, others) Size: 70m2
- Fencing equipment suppliers Size: 60m2
- Other Size: 100m2
- 

### 10.7 Specification and Description of the Equipment available in Each Room

- Computers, tables,
- printers,
- photocopier,
- telephone with international line,
- fax
- chairs,
- sofas,
- stationery,

- high-speed internet
- scanner
- 1 filing cabinet that can be locked with a key
- In each of these rooms, a selection of refreshments including water, tea and coffee will be provided every day.
- These rooms will be lockable by key

### 10.8 Catering Facilities at the Venue

Number of Restaurants- two

Number of Snacks (Sandwiches and fast Food Service)- 4

Number of Drinks Sale Services 4

Number of Tuck Shops 4

### 10.9 Food and Refreshment Prices (Attach Price Lists)

---

Attached example

### 10.10 Staff in the Venue

- Professionals  Number: 25
- Volunteers  Number: 160

## 11. Material and Equipment

a) Name of the supplier of fencing material and equipment for Weapon Control:  
UHLMANN

b) List of equipment for weapon control:  
TBOX COMPETITION  
The TBOX COMPETITION

is a precision measuring device that can test weapons, cables, cable reels, vests, mask bibs, installation cables

TBOX 2GO

The TBOX 2GO is a small testing device that allows everyone to test weapons, cables, cable reels, metal vests and pistes easily

.  
TESTER FOR METAL VESTS FIE 500G, ELECTRIC  
GAUGES WITH CASE  
TEST WEIGHT UNIVERSAL, 750G

consists of two parts: 500 g and 250 g  
TEST BOARD FOR WEAPONS, WITH ACCESSORIES

checking of length, guard diameters, depth of guards and flexibility of blades, complete with accessories

Canon i-SENSYS MF264dw Printer (3-in-1 MFP) (Laser)  
Notebook Acer Aspire 3 A315-34-C59F (NX.HE3ER.003)

Tables

Chairs

c) Name of the supplier of fencing material and equipment: for fencing halls

ALL STAR Company or Absolute Company

d) Name of apparatus and reels (supplier/model):

ALL STAR or FAVERO COMPANIES - Model FA 07, Reels – 900 1-C

e) Name of supplier of fencing pistes:

All star Company or Absolute Company

f) Name of software for the management of the competitions:

Fencing time life

g) Name of the person in charge of computers in the OC:

Merzlyakov Aleksanrd

h) Number of computers for the management of the competitions: 40

## 12. Accommodation and Transportation

### 12.1 Available International Travel Options

- Airplane  Name of the Airport Islam Karimov International Airport
- Train  Name of the Station Tashkent main train station
- Other  Details: \_\_\_\_\_

---



---



---

### 12.2 Category, Number and Prices of the Officially Selected Hotels

Venue	Number of Hotels	Price P/P Single standard Room with breakfast	Price P/P Double standard Room with breakfast
Hotel Category 1	3	From 160\$	From 105\$
Hotel Category 2	4	From 120 \$	From 80\$
Hotel Category 3	4	From 65\$	From 50\$

### 12.3 Distance between the Airport / Railway Station and Hotels

Venue	Distance (km)	Timing (hrs) in depends of the traffics
Hotel Category 1	From 8 km	From 12 min

Hotel Category 2	From 5 km	From 9 min
Hotel Category 3	From 6 km	From 10 min

#### 12.4 Distance between Hotels and Competition Venue

Venue	Distance (km)	Timing (hrs) in depend of the traffics
Hotel Category 1	From 1 km	From 5 min
Hotel Category 2	From 5 km	From 8 min
Hotel Category 3	From 5 km	From 8 min

#### 12.5 Arrangement for Transportation of Delegations

Transport Description	Bus	Mini-Bus	Shuttle	Other	Price
From Airport/ Station to Hotels	yes	yes			20\$ per person
From Hotels to Competition Venues			yes		
From Hotels to Training Venues			yes		

#### 12.6 Arrangement for Transportation of Officials

Transport Description	Bus	Mini-Bus	Shuttle	Other	Price
From Airport/ Station to Hotels		yes		cars	20\$ per person
From Hotels to Competition Venues		yes		cars	

### 13. Publicity and Promotion

What publicity and promotion methods you plan to use:

- Advertisements on Radio
- Advertisements on TV
- Press conferences
- Street Posters and Bans
- Dedicated website/social media
- Other

Present details of the publicity and promotion plan:

1. Creation of promotional videos about the Fencing JC World Championship
2. Holding regularly Press Conferences about fencing and World Championship
3. Participation in TV programs
4. Participation and advertising on Radio for the preparation and organization of the Fencing JC World Championship
5. Promotion in social networks of commercials about the Fencing JC World Cup.

**14. Tickets and Derived Products**

- How many tickets you expect to sell during the WC? free
- What price of tickets you will apply? free

**15. Press Coverage**

Press coverage of the World Championship must be in line with the FIE Press Handbook.

**Do you herewith confirm that you are committed to implement the FIE Press Handbook?** YES  NO

**16. Television Coverage**

TV coverage of the World Championship must be in line with the FIE Television Handbook.

**Do you herewith confirm that you are committed to implement the FIE Television Handbook?** YES  NO

**16.1 Details of the Television Coverage Plan**

- National TV Channels
  - Live Broadcast  Number of Hours: Will available our according request
  - Recorded Broadcast  Number of Hours: will available according our request
- Regional TV Channels
  - Live Broadcast  Number of Hours: Will available our according request
  - Recorded Broadcast  Number of Hours: Will available our according request
  - Other

Present details of the TV Coverage plan:

**PREPARATIONS**

- OC to organize a visit of the venue with the representative of the Host Broadcaster and the FIE's Director of Television Production for discussion according approving and organizations matters.

- Constructions in the venue for responsible for providing certain facilities at the FIE Championships to enable the respective Host Broadcaster to fulfill its responsibilities.

Organization Commentary Positions (Television and Radio)

-the equipment for 3 commentators (2 in case of radio)

-Sufficient electricity outlet points

-Connection to a normal telephone and internet

-A data information system (CIS – commentator information system),

-TV Monitor

-Will organized the number of commentary positions at least three (3) months before the Championship.

- Organization camera platforms/positions that will be agreed upon by the HB and FIE's Director of Television Broadcast

- Organization Interview Areas. OC will provide locations for pre and post event unilateral interviews, that will be planned at the same time as the camera platforms, and will be agreed upon by the HB and the FIE as well.

- Organization Lighting, will organize a minimum of 1400 Lux in all areas where competitions take place.

- Will provide sufficient electric power, including emergency back-up sources, to ensure the full and effective operation of all lighting and broadcasting equipment.

- According rules, the International Feed will begin 60 minutes before, and continue until at least 5 minutes after the conclusion of the Championship's programme. The beginning and the end of the broadcast is to be finalized by the FIE, the OC and the HB.

After the opening animation 15 second long shots are required for television stations being able to join the live broadcast.

- All broadcasted events will be recorded by the Host Broadcaster in HD quality and on DVD.

## **17. Marketing plan**

### **17.1 Details of the Marketing Plan**

---

Organize and established financial support on short-term and long-term actions to drive revenue and participation in organization preparation of Fencing JC World Championship with:

- Government
- Sponsorship
- Donors
- via media exposure and social media impact goals at all levels
- Explore opportunities to partner with national and/or regional organizations to expand reach of support of Fencing World Championship.
- Achieve IT goals to enhance additional promotion of the event
- Horough work internal and external analysis reviewing Objectives, Audience, Brand to maximise potential and the appeal to sponsors, build the interest to the Fencing World Championship.

### **17.2 Date when the complete Marketing Plan will be submitted to the FIE**

**Marketing plan will provide to FIE till January 2023.**

## **18. Sponsors**

### **18.1 Sponsors Selection**

Organising Committee cannot approach or make sponsorship arrangements with any company that is competitor with the major FIE sponsors.

**Do you herewith confirm that you will comply with presented criteria for selection of the sponsors?** YES  NO



**Do you herewith confirm that you are committed to implement Requirements that are specified in the FIE Press Handbook and the FIE Handbook of Regulations for WC?** YES  NO

**18.2 Date when the complete List of Sponsors will be submitted to the FIE till end of December 2023**

### **19. Protocol**

The protocol ceremonies must be organised as specified in the FIE Handbook of Regulations for the Organization of Protocol Ceremonies at FIE Competitions.

The FIE Chief of Protocol coordinates with the LOC Protocol Manager to ensure that all elements of FIE protocol are respected.

**Do you herewith confirm that Protocol will be organised according to this FIE document?** YES  NO

### **20. Medical Service**

Medical Service is to be provided in accordance for by the FIE Rules, the FIE Administrative Rules, the FIE Handbooks of Regulations and FIE Medical Handbook.

**Do you herewith confirm that you will comply organization of the Medical Service with the listed FIE Documents?** YES  NO

Medical Service is covering Medical Emergencies, Sports Trauma, General Medical Care and Additional Medical Services (Physiotherapy etc.).

Basic requirements are as follows

- Medical Stations, with locally licenced paramedic or doctor, must be present in competition halls, **MAXIMUM two (2) minutes away from the furthest hall**, and properly marked;
- Adequate ambulance must be present on site or **MAXIMUM at ten (10) minutes' drive distance**;
- Hospital with the emergency ward and facilities required for treatment of the possible injuries and illnesses must be selected and arrangements made for adequate support in case of emergency;

**Do you herewith confirm that you will meet Medical Service requirements?** YES  NO

### **21. Doping Control**

According to the FIE Anti-Doping Rules, Doping Control tests are obligatory at all World Championships.

Testing process must be strictly managed according to the WADA regulations.

Doping Control Office (DCO) must be supplied by the National Anti-Doping Organization (NADO).

Analysis of the samples must be performed by the IOC accredited laboratory. Coordinator of the doping control is the FIE Medical Delegate.

Doping Control station must be allocated as close as possible to the Finals venue, with all required facilities to accommodate limited access, privacy, preparation of the documentation, taking and processing samples.

Sample collection bottles, containers and forms are to be supplied the NADO.

**Do you herewith confirm that you will meet Doping Control requirements according to these regulations? YES  NO**

## **22. Security**

The Organizing Committee has to organise Security and Safety Service in order to provide:

- The health and physical security of all the participants;
- Safety of all the installed equipment;
- Regulation of access to various sites of the competition in line with the applied accreditation;
- No unauthorised access of the pistes and official rooms by the public;
- Good and safe circulation of people;

Also, discreet police service and the presence of a fire service is to be planned.

**Do you herewith confirm that you will meet presented Security requirements? YES  NO**

## **23. Insurance**

The Organising Committee must, at its own costs, institute:

- Liability Insurance policy which will include general liability coverage, as well as a guarantee for non-consecutive intangible damages (pure financial loss).
- All other mandatory insurance, such as:
  - ❖ Fire and fire damage insurance policies for premises necessary to the organisation
  - ❖ Automobile insurance policies (if necessary)
  - ❖ All policies mandated by local legislation.
- Repatriation Assistance coverage for the Fencing family, but without covering the designated officials or referees, the Executive Committee, or FIE personnel.

**Do you herewith confirm that you will meet presented Insurance requirements? YES  NO**

## **24. Rewards for the Winners**

**YES  NO**

Present details of the planned Rewards for the Winners:

The Rewarding ceremony will be organized according to FIE rules. Will be awarded medals, diplomas and national presents.

## **25. Cultural Programme Plan**

**YES  NO**

Present details of the Cultural Plan: To all participants will be offered a culture plan as a sightseeing tour around Tashkent or trips to main world famous cities such as Samarkand, Bukhara.

## **26. Environmental Protection Plan**

**YES  NO**

Present details of the Environmental Protection Plan: \_\_\_\_\_

- Promote and further develop fencing which are compatible with nature and the environment;
- The work or activity is conducted in a manner that conforms to the environmental policy;
- Producing the promotion information boards Environmental Protection before and during event ;
- Systematically informing and educating people practising fencing about the possibilities for fencing activities without
- affecting nature or the environment

## **Letter of commitment**

Letter of Commitment

The national federation of Uzbekistan

hereby bidding to the organization of the World Championships of Junior and Cadet 2026

- 1) Hereby confirms that it has full knowledge of all its obligations and financial obligations to organise an FIE World Championships
- 2) Hereby confirms that it is committed:
  - a) to respect and implement the FIE Statutes, including articles 1.2.4 and 1.2.5, the FIE Ethics and Safeguarding codes, the FIE rules, the FIE Administrative Rules, the FIE handbook of regulations, FIE Protocol handbook and any FIE rule in force.
  - b) to respect Its financial obligations
- 3) confirms that it has received from its national authorities a written agreement guaranteeing the granting of visas to all the participants of the member national federations of the FIE.

15.09.2023



Signature, stamp



**O‘ZBEKISTON RESPUBLIKASI YOSHLAR SIYOSATI VA SPORT VAZIRLIGI**  
**MINISTRY OF YOUTH POLICY AND SPORTS OF THE REPUBLIC OF UZBEKISTAN**  
100017, Toshkent shahar, A.Qodiriy ko‘chasi, 2-uy, tel.: (998 71) 239-24-21, (998 71) 239-24-22  
veb-sayt: www.minsport.uz, e-mail: info@minsport.uz, e-xat: sport@exat.uz

Toshkent shahri

18«10»2023 yil.

**03-01/03/14/14-01/6179-son**

### **O'zbekiston qilichbozlik federatsiyasiga**

O'zbekiston Respublikasi Prezidentining "O'zbekiston Respublikasi da jismoniy tarbiya va sportni yanada takomillash tirish va ommalash tirish chora-tadbirlari to'g'risida" 2023 yil 28 yanvardagi PF-5924-son Farmoni bilan "O'zbekiston Respublikasi Yoshlar siyosati va sport Vazirligi 2028 yilgacha rivojlantirish konsepsiyasining maqsadli ko'rsatkichlari" tasdiqlangan. Ushbu Farmonga muvofiq 2026 yil da O'zbekiston dajami 35 ta Osiyo, Jahon chempionati, Osiyo va Jahon Kubogi nufuzli xalqaro sport musobaqalari nio'tkazish belgilangan. Mazkur ko'rsatkichlarga erishish maqsadida, Yoshlar siyosati va sport vazirligi 2026 yilda qilichbozlik bo'yicha yoshlar o'rtasida jahon chempionatini O'zbekistonda o'tkazilishini qo'llab quvvatlaydi.

**Вазир ўринбосари**

**Ш.Махмудов**

**To the Fencing Federation of Uzbekistan**

Decree of the President of the Republic of Uzbekistan "On measures to further improve and popularize physical culture and sports in the Republic of Uzbekistan" dated January 28, 2023 No PF-5924 approved "Targets of the Concept of Development of Physical Culture and Sports of the Republic of Uzbekistan until 2028."

In accordance with this Decree, in 2026, Uzbekistan is planning to host a total of 35 prestigious international sports competitions, including the Asian, World Championships, Asian and World Cups.

In order to achieve these results, the Ministry of Youth Policy and Sport of Republic of Uzbekistan supports the organization of the Juniors and Cadets World Fencing Championship in 2026 in Uzbekistan.

**Deputy Minister**

**Sh. Mahmudov**



**BID QUESTIONNAIRE**

**FOR ORGANISATION**

**OF THE 2026 SENIOR FENCING WORLD CHAMPIONSHIPS**

**By Hong Kong Fencing Association  
May 2023**

## IMPORTANT INFORMATION FOR BIDDING FEDERATIONS

- ❖ The FIE assigns the organisation of the World Championships to the National Federation of the host city. This federation will create a World Championships Organising Committee, which, coordinating at all times with the National Federation, will, from its inception, communicate directly with the FIE, from whom it receives its instructions.
- ❖ The Organising Committee must comply with the Rules, Statutes, Administrative Rules and the Handbook of Regulations of the FIE from its inception up until its dissolution.
- ❖ The FIE retains the right of final say on all questions pertaining to the World Championships.
- ❖ The bid must be sent by the national federation and reach the FIE Head Office **three (3) years before** the date of organization of the World Championships, before the Congress. On this occasion the candidates will be announced.
- ❖ The complete file of candidature must reach the FIE Head Office before the 1<sup>st</sup> of September.
- ❖ The candidate federation will have to make a commitment, in front of the Congress, to respect the FIE Handbooks of regulations and its financial obligations. A signed protocol between the FIE and the organizing federation will state its perfect knowledge of its obligation
- ❖ The bid procedure has to take place according to the FIE statutes
- ❖ The Organising Federation must provide a written agreement from the Ministry of Foreign Affairs guaranteeing the granting of visas to all the participants of the member national federations of the FIE.
- ❖ As specified on the relevant articles of the questionnaire it is obligatory to present plans and dimensions of all the competition venues attached to this document.

**Do you herewith accept the presented FIE bidding rules, procedure and specified special requirements?                      YES                       NO**



## QUESTIONNAIRE

1. **Name of the Bidding Federation**

Hong Kong Fencing Association

2. **Bidding Event (tick the corresponding square)**

- Senior World Championship

3. **Place and dates of the event**

Place City / Town: Hong Kong, China

Dates: From 20 July To 30 July Year 2026 (TBC)

4. **Presentation of the City/Town**

- Present map with marked position of competition venues, hotels, airport, train station etc.

**MAP**



- City/Town details (Population, surface, climate, height etc.)

Hong Kong is a seaside city with a total land area of 1,114.35 square kilometres located at the south-eastern tip of China. The population was approximately 7.41 million.

Hong Kong has a subtropical climate. May to August are hot and humid with occasional showers and thunderstorms, particularly during the mornings. Afternoon temperatures often exceed 31 Degree C whereas at night, temperatures generally remain around 26 Degree C with high humidity. There is usually a fine dry spell in July which may possibly last for one to two weeks, or for even longer in some years.

- Present the major fencing competitions or other sports tournaments already organized in this city/town  
2008 Beijing Olympic Games (Equestrian event)  
2009 East Asian Games  
Hong Kong Rugby Sevens  
FIVB Volleyball Nations League Hong Kong  
UCI Track Cycling Nations Cup, Hong Kong  
Standard Chartered Marathon Hong Kong  
2017 Asian Fencing Championships

## 5. Composition of the Organising Committee

### 5.1 Organizing Committee Management

Title	Surname	Name	Contact Details
Chairman	Yeung	Wing Sun A.N.W.	<a href="mailto:wally@hkfa.org.hk">wally@hkfa.org.hk</a>
Secretary General	Tsui	Man Sum Vincent	<a href="mailto:vincent@hkfa.org.hk">vincent@hkfa.org.hk</a>
Treasurer	Cheung	Ting Pong	<a href="mailto:barry@hkfa.org.hk">barry@hkfa.org.hk</a>

### 5.2 Organising Committee Important Portfolios

Portfolio	Surname	Name	Contact Details
Administration	Ko	Hin Hei	<a href="mailto:heiko@hkfa.org.hk">heiko@hkfa.org.hk</a>
Invitation of Participants	Liu	Ka Leung	<a href="mailto:liu@hkfa.org.hk">liu@hkfa.org.hk</a>
Invitation of Officials	Liu	Ka Leung	<a href="mailto:liu@hkfa.org.hk">liu@hkfa.org.hk</a>
Immigration and Visas	Ko	Hin Hei	<a href="mailto:heiko@hkfa.org.hk">heiko@hkfa.org.hk</a>
Entries and Accreditations	Ko	Hin Hei	<a href="mailto:heiko@hkfa.org.hk">heiko@hkfa.org.hk</a>
Technical Organization	Tsui	Man Sum Vincent	<a href="mailto:vincent@hkfa.org.hk">vincent@hkfa.org.hk</a>
Venue Renting	Tsui	Man Sum Vincent	<a href="mailto:vincent@hkfa.org.hk">vincent@hkfa.org.hk</a>
Telecommunications	Lau	Tsz Kin	<a href="mailto:competition@hkfa.org.hk">competition@hkfa.org.hk</a>
IT Support	Lau	Tsz Kin	<a href="mailto:competition@hkfa.org.hk">competition@hkfa.org.hk</a>
Safety and Security	Cheung	Kam Po Willy	<a href="mailto:info@hkfa.org.hk">info@hkfa.org.hk</a>
Accommodation	Yu	Hui Yin	<a href="mailto:nicola@hkfa.org.hk">nicola@hkfa.org.hk</a>
Catering and Refreshments	Chan	Tsui Ying	<a href="mailto:adachan@hkfa.org.hk">adachan@hkfa.org.hk</a>
Transportation	Yu	Hui Yin	<a href="mailto:nicola@hkfa.org.hk">nicola@hkfa.org.hk</a>
Technical Support	Lau	Tsz Kin	<a href="mailto:competition@hkfa.org.hk">competition@hkfa.org.hk</a>
Maintenance	Cheung	Hau Lun	<a href="mailto:alan@hkfa.org.hk">alan@hkfa.org.hk</a>
Publicity and Promotion	Chan	Kin Pong Clerebold	<a href="mailto:pr@hkfa.org.hk">pr@hkfa.org.hk</a>

Press and Media Relations	Chan	Kin Pong Clerebold	<a href="mailto:pr@hkfa.org.hk">pr@hkfa.org.hk</a>
Relations with Officials	Au Yeung	Wai Sum	<a href="mailto:competition@hkfa.org.hk">competition@hkfa.org.hk</a>
Call Room Services	Liu	Firen	<a href="mailto:competition@hkfa.org.hk">competition@hkfa.org.hk</a>
Equipment Control	Ng	Chung Him	<a href="mailto:jeff@hkfa.org.hk">jeff@hkfa.org.hk</a>
Medical Service	Fong	Siu Yan	<a href="mailto:info@hkfa.org.hk">info@hkfa.org.hk</a>
Protocol	Ko	Hin Hei	<a href="mailto:heiko@hkfa.org.hk">heiko@hkfa.org.hk</a>
Sound System	Cheung	Hau Lun	<a href="mailto:alan@hkfa.org.hk">alan@hkfa.org.hk</a>

## 6. Organising Committee Contact Details

Physical Address:

1011 Olympic House, 1 Stadium Path, So Kon Po, Causeway Bay, Hong Kong, China

Postal address: Same as above

Tel.: (852) 2504-8106

Fax: (852) 2577-5299

E-mail: info@hkfa.org.hk

Url: www.hkfa.org.hk

Mobile Phone: (852) 9016-4423 (Chairman)

## 7. Financing

The following is detailed Budget of the event, with specified sources of the Income and estimated Expenditures:

### 7.1 Income

Description	Amount (HKD)
Public Subventions	
• National	15m
Business Sponsors and Partners	1.5m
Private Sponsors and Donors	2m
Official providers	
• Accommodation	1m
• Equipment	2.5m
• Production	1.5m
• Transportation	1m
• Venue	5m
Miscellaneous Sales	
• Tickets	1.17m
• Rent of Stands	400k
• By-products	200k
• TV Rights	500k
Other	
<b>Total</b>	<b>29.97m (US\$3.84m)</b>

## 7.2 Expenditures

Description	Amount (HKD)
• Accommodation	1300000
• Accreditation	200000
• Anti-doping service	180000
• Ceremonies and receptions	500000
• Computering & Results system	300000
• FIE guests, officials and VIP	500000
• Food and Beverage	300000
• Hostesses, Interpreters, Drivers etc....	200000
• Insurance	100000
• Local transportation	300000
• Medical service	250000
• Officials	1000000
• Organizing Committee & Administrators	3500000
• Other equipment	500000
• Oversea transportation	900000
• Pistes and equipment specific to fencing	3500000
• Promotion and Publicity	100000
• Remuneration for FIE Official & Referees	450000
• Venue (including air conditioning, cleaning, electricity, lighting, network, security, sound system & technicians)	13700000
• Venue setup and decoration	1500000
• Volunteers	300000
• Wireless	400000
<b>Total</b>	<b>29.98m (US\$3.84m)</b>

## 7.3 Financial Guarantees

The **organizing federation** is committed to produce a guarantee to the FIE, three months before the date of the World championships, for the amount of **100 000 euro**, either by a **deposit**, or by a **bank guarantee**.

**Do you herewith confirm that you will present the Financial Guarantees?**

YES  NO

Transfer confirmation document or Bank Guarantee must be attached to this document.

The balance of the deposit or the guarantee will be returned to the organizing federation within one month after the end of the World championships if all requirements of the FIE have been fulfilled.

## 8. Official Support Documents from the National and/or Local Authorities

**Can you provide Official Support Documents from the National and/or Local Authorities (including visa guarantee letter)?**

YES  NO

If YES, these documents are to be listed and attached to this document.

Authority	Document
Culture, Sports and Tourism Bureau	Funding supporting document
Immigration Department	Immigration facilitation for visitors participating in short-term activities in sports sector (subjected to the final confirmation)

**9. Event Program**

Detailed Program of the event will be submitted to the FIE Executive committee for approval.

Typical program of the Senior World Championship is as follows:

DAY 1 - Monday		
Meeting of the Organising Committee, the Directoire Technique and the technical, technological and software service providers		
DAY 2 - Tuesday		
Referees meeting and seminar Directoire Technique meeting		
DAY 3 - Wednesday		
Women's Epee	Pools, Preliminary DE up to 64	HALL <u>Preliminaries</u>
Men's Sabre	Pools, Preliminary DE up to 64	HALL <u>Preliminaries</u>
DAY 4 - Wednesday		
Women's Foil	Pools, Preliminary DE up to 64	HALL <u>Preliminaries</u>
Men's Epée	Pools, Preliminary DE up to 64	HALL <u>Preliminaries</u>
DAY 5 - Friday		
Women's Sabre	Pools, Preliminary DE up to 64	HALL <u>Preliminaries</u>
Men's Foil	Pools, Preliminary DE up to 64	HALL <u>Preliminaries</u>
DAY 6 – Saturday		
Women's Epee individual	T64 - Final	HALL <u>DE &amp; Final</u>
Men's Sabre individual	T64 - Final	HALL <u>DE &amp; Final</u>
<b>Opening Ceremony</b>		HALL <u>DE &amp; Final</u>
DAY 7 – Sunday		
Women's Foil individual	T64 - Final	HALL <u>DE &amp; Final</u>
Men's Epee individual	T64 - Final	HALL <u>DE &amp; Final</u>
DAY 8 – Monday		
Women's Sabre individual	T64 - Final	HALL <u>DE &amp; Final</u>
Men's Foil individual	T64 - Final	HALL <u>DE &amp; Final</u>
Women's Epee Team	T64 up to 8	HALL Preliminaries HALLS <u>DE &amp; Final</u>
Men's Sabre Team	T64 up to 8	HALL Preliminaries HALLS <u>DE &amp; Final</u>
DAY 9 – Tuesday		
Women's Epee Team	T8 - 3 place- 1 place	HALL <u>DE &amp; Final</u>

Men's Sabre Team	T8 3 place- 1 place	HALL <u>DE &amp; Final</u>
Women's Foil Team	T64 up to 8	HALL Preliminaries HALLS <u>DE &amp; Final</u>
Men's Epee Team	T64 up to 8	HALL Preliminaries HALLS <u>DE &amp; Final</u>
<b>DAY 10 – Wednesday</b>		
Women's Foil Team	T8 3 place- 1 place	HALL <u>DE &amp; Final</u>
Men's Epee Team	T8 3 place- 1 place	HALL <u>DE &amp; Final</u>
Women's Sabre Team	T64 up to 8	HALL Preliminaries HALLS <u>DE &amp; Final</u>
Men's Foil Team	T64 up to 8	HALL Preliminaries HALLS <u>DE &amp; Final</u>
<b>DAY 11 – Thursday</b>		
Women's Sabre Team	T8 3 place- 1 place	HALL <u>DE &amp; Final</u>
Men's Foil Team	T8 3 place- 1 place	HALL <u>DE &amp; Final</u>
<b>Closing Ceremony</b>		HALL <u>DE &amp; Final</u>

Do you herewith confirm that you will implement the presented Typical Program of the Senior World Championship? YES  NO

#### 10. Venue for the Competition

Name of the Venue: AsiaWorld-Expo

Address of the Venue: Hong Kong International Airport, Lantau, Hong Kong

Number of the Available Halls: 11

Number of Halls to be Used: 4

#### 10.1 Allocation of the Selected Halls:

##### 10.1.1 Preliminary Phase Halls

- Number of Preliminary Phase Halls: 1
- Dimensions of each Hall: 11,360 square metres
- Number of Pistes at each Hall: 32
- Total Number of Pistes: 32
- Average Width of the Refereeing Zone: 5m from the piste

#### **DRAWINGS OF THE PRELIMINARY PHASE HALLS**

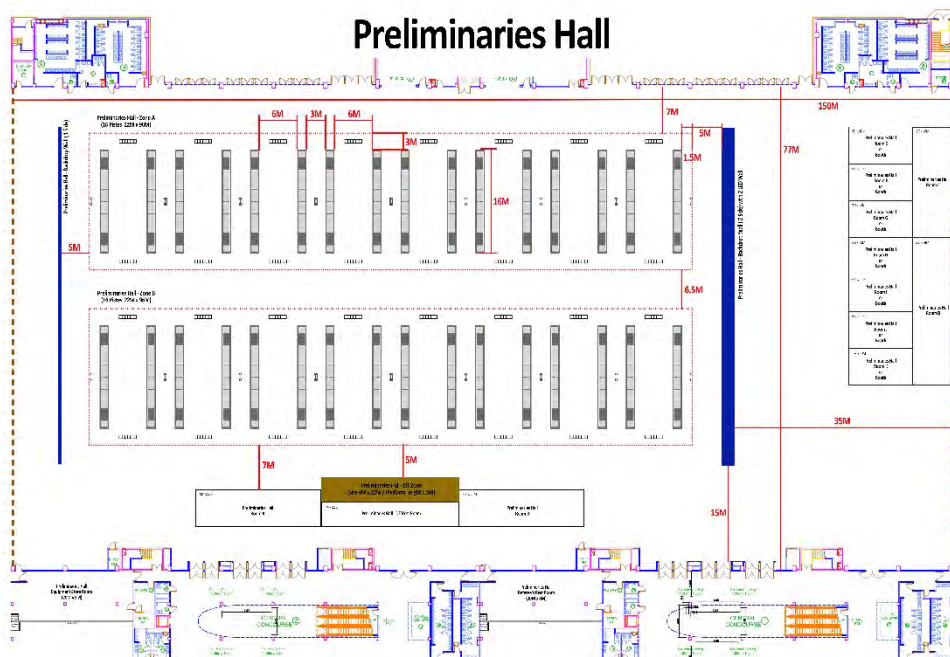

**10.1.2 Hall for the Direct Elimination and Finals with Single Piste and four (4) Coloured Pistes.**

- |   |            |                                     |           |                          |
|---|------------|-------------------------------------|-----------|--------------------------|
|   | <b>YES</b> | <input checked="" type="checkbox"/> | <b>NO</b> | <input type="checkbox"/> |
| • Blue carpet on the entire square four (4) Coloured Pistes and around podium (Final piste)                   | <b>YES</b> | <input checked="" type="checkbox"/> | <b>NO</b> | <input type="checkbox"/> |
| • Dimensions of the Hall: <u>10,880</u> square metres   |            |                                     |           |                          |
| • Four (4) Coloured Pistes in different colours   | <b>YES</b> | <input checked="" type="checkbox"/> | <b>NO</b> | <input type="checkbox"/> |
| • Wireless System   | <b>YES</b> | <input checked="" type="checkbox"/> | <b>NO</b> | <input type="checkbox"/> |
| • Location for the Video-Refereeing Camera on the same side as the referee, outside of Refereeing zone        | <b>YES</b> | <input checked="" type="checkbox"/> | <b>NO</b> | <input type="checkbox"/> |
| • Video Refereeing Station on the same side as the referee, outside of Refereeing zone                        | <b>YES</b> | <input checked="" type="checkbox"/> | <b>NO</b> | <input type="checkbox"/> |
| • One (1) Final Piste 1.5m to 2m wide, 18m Long   | <b>YES</b> | <input checked="" type="checkbox"/> | <b>NO</b> | <input type="checkbox"/> |
| • Piste on the podium 30 – 50cm raised, with lateral safety minimum 25cm and inclines at the end of the piste | <b>YES</b> | <input checked="" type="checkbox"/> | <b>NO</b> | <input type="checkbox"/> |
| • Refereeing zone 4.0 – 4.5m from the piste   | <b>YES</b> | <input checked="" type="checkbox"/> | <b>NO</b> | <input type="checkbox"/> |
| • Wireless System   | <b>YES</b> | <input checked="" type="checkbox"/> | <b>NO</b> | <input type="checkbox"/> |
| • Location for the Video-Refereeing Camera on the same side as the referee, outside of Refereeing zone        | <b>YES</b> | <input checked="" type="checkbox"/> | <b>NO</b> | <input type="checkbox"/> |
| • Video Refereeing Station on the same side as the referee, outside of Refereeing zone (4.0 m minimum)        | <b>YES</b> | <input checked="" type="checkbox"/> | <b>NO</b> | <input type="checkbox"/> |
| • Wireless Microphone for the Referees  | <b>YES</b> | <input checked="" type="checkbox"/> | <b>NO</b> | <input type="checkbox"/> |

**DRAWINGS OF THE HALL FOR DIRECT ELIMINATION AND FINALS**



## Direct Eliminations and Final Hall

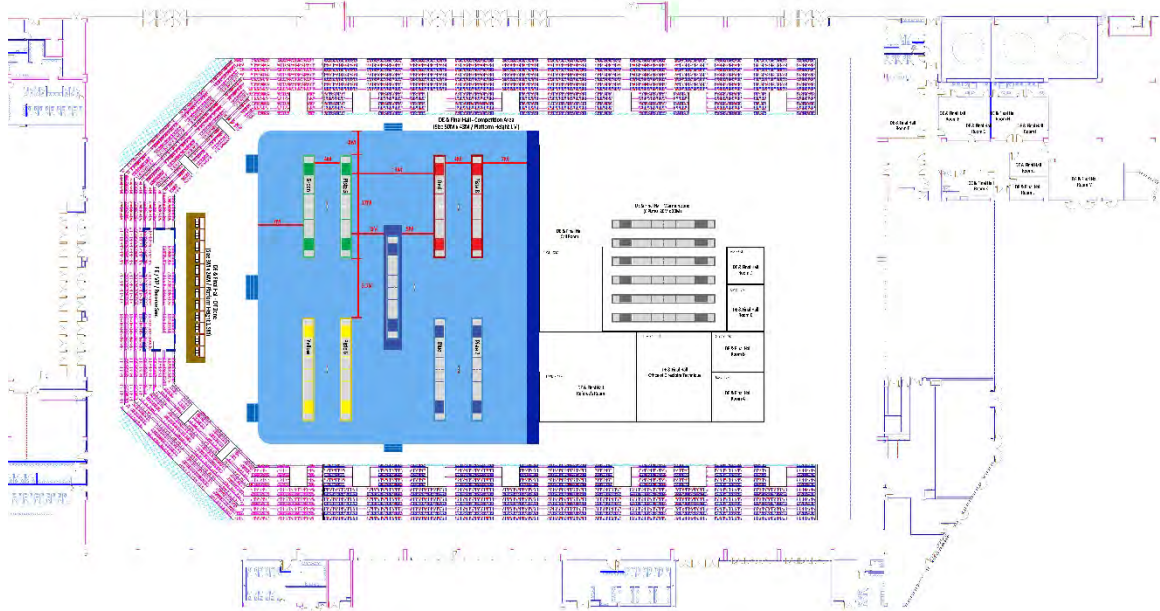

### 10.1.3 Training Halls

YES  NO

- Number of Training Halls: 1
- Dimensions of the Halls: 8,200 square metres
- Total Number of Pistes: 24
- Total Number of Team boxes 124 (depends on the number of participating nations)
- Team box dimensions (for National team) 3.5 x 3 m

### DRAWINGS OF THE TRAINING HALL





**10.1.4 Warm-up Halls**

**YES**  **NO**

- Number of Warm-up Halls: 1  
(inside the Hall for DE & Final)

**10.2 Capacity of Spectators per Each Hall**

Preliminary Phase Halls: 2,500 pax (standing)  
Hall for the Direct Elimination & Finals: 12,500 pax (seating)

**10.3 Rest rooms for the Athletes**

**YES**  **NO**

- Number of Rest Rooms for Athletes: 30
- Dimensions of Rest Rooms: Ranged from 6 x 6m to 6 x 10m

**10.4 Rooms for Control of Weapons and Equipment**

- Size of the selected room 390 m<sup>2</sup> (Minimum 150m<sup>2</sup>.)
- Room must be operational and open 72 hours before the beginning of the first event. Is that realisable? **YES**  **NO**

**10.5 Office of Directoire Technique**

- Size of the selected room 175 m<sup>2</sup> x 2 (Recommended 150-200m<sup>2</sup>.)
- Internet access and ADSL/Fiber Optic Line **YES**  **NO**
- Six (6) Tables of 2m length **YES**  **NO**
- Two (2) Computers for administration **YES**  **NO**
- Two (2) Computers with Printers **YES**  **NO**

- |   |   |                             |
|---|---|-----------------------------|
| • Reserve set of equipment (computers, printers, cartridges etc.) | YES <input checked="" type="checkbox"/> | NO <input type="checkbox"/> |
| • One (1) High-performance Photocopier                            | YES <input checked="" type="checkbox"/> | NO <input type="checkbox"/> |
| • Telephone Line and Telephone                                    | YES <input checked="" type="checkbox"/> | NO <input type="checkbox"/> |
| • Two (2) Wireless Microphones                                    | YES <input checked="" type="checkbox"/> | NO <input type="checkbox"/> |
| • Notice Board  | YES <input checked="" type="checkbox"/> | NO <input type="checkbox"/> |

**10.6 Other rooms and halls (tick the existing)**

- |  |                                    |
|--|------------------------------------|
| • <input checked="" type="checkbox"/> FIE Offices  | Size: <u>150 m<sup>2</sup></u>     |
| • <input checked="" type="checkbox"/> President's office                                 | Size: <u>150 m<sup>2</sup></u>     |
| • <input checked="" type="checkbox"/> Secretary General/Treasurer's office               | Size: <u>150 m<sup>2</sup></u>     |
| • <input checked="" type="checkbox"/> FIE Meetings Room                                  | Size: <u>100 m<sup>2</sup></u>     |
| • <input checked="" type="checkbox"/> OC Room  | Size: <u>100 m<sup>2</sup></u>     |
| • <input checked="" type="checkbox"/> Referees Room (min 150m2)                          | Size: <u>160 m<sup>2</sup> x 2</u> |
| • <input checked="" type="checkbox"/> Doping Control Station                             | Size: <u>100 m<sup>2</sup></u>     |
| • <input checked="" type="checkbox"/> Accreditation Room (min 100m2)                     | Size: <u>150 m<sup>2</sup></u>     |
| • <input checked="" type="checkbox"/> Information Centre                                 | Size: <u>200 m<sup>2</sup></u>     |
| • <input checked="" type="checkbox"/> Press Centre (equipped)                            | Size: <u>500 m<sup>2</sup></u>     |
| • <input checked="" type="checkbox"/> Conference Room                                    | Size: <u>200 m<sup>2</sup></u>     |
| • <input checked="" type="checkbox"/> FIE Stands (DYFG, Clean sport, Safe sport, others) | Size: <u>3 x 3.5m each</u>         |
| • <input checked="" type="checkbox"/> Fencing equipment suppliers                        | Size: <u>3 x 3.5m each</u>         |
| • <input type="checkbox"/> Other   | Size: _____                        |

**10.7 Specification and Description of the Equipment available in Each Room**

- Tables with chairs
- Computers with printers
- Internet access with fax function
- Reserve equipment in case of malfunction (printers, computers, ink cartridges, etc.)
- Photocopier
- Telephone
- Stationary
- Drinking Water

**Catering Facilities at the Venue**

- Number of Restaurants 3
- Number of Snacks (Sandwiches and fast Food Service) 9
- Number of Drinks Sale Services 9
- Number of Tuck Shops 3

**10.8 Food and Refreshment Prices (Attach Price Lists)**

Pre-order lunch box ~US10-15 each for teams

For the general:

Set-lunch (Western): US10-30 per head

Set-lunch (Chinese): US10-30 per head  
Fast food meal: US5-10 per head  
Sandwiches: US4-8 per head  
Coffee & Tea: US3-10 per head  
Snacks: \$US3-8  
(The detailed price list would be provided in later stage.)

**10.9 Staff in the Venue**

- Professionals  Number: 100
- Volunteers  Number: 100

**11. Material and Equipment**

a) Name of the supplier of fencing material and equipment for Weapon Control:  
Absolute Fencing / Favero / PBT / Allstar

b) List of equipment for weapon control:

- Testing Table
- Eddy Current Machines
- Electrical testing devices
- Weighing Machines
- Universal Weights for testing
- Mask punch tester
- Testing Gauges
- Engraving machines
- Vernier / Micrometers
- Measures of Length
- Stamp / Sticker
- Cable ties
- Digital camera

c) Name of the supplier of fencing material and equipment: for fencing halls  
Absolute Fencing

d) Name of apparatus and reels (supplier/model):  
Scoring machine sets: Favero FA07 Sets  
Reels and floor cables: Favero

e) Name of supplier of fencing pistes:  
Absolute Fencing

f) Name of software for the management of the competitions:  
Fencing Time

g) Name of the person in charge of computers in the OC:  
Kan Sze Man Linda

h) Number of computers for the management of the competitions:  
8

## **12. Accommodation and Transportation**

### **12.1 Available International Travel Options**

- Airplane  Name of the Airport Hong Kong International Airport
- Train  Name of the Station \_\_\_\_\_
- Other  Details: Bus or ferry from Macau or China

### **12.2 Category, Number and Prices of the Officially Selected Hotels**

Venue (by distance)	Number of Hotels	Price /room Single Room	Price /room Double Room	Price /room Single Room w/Breakfast	Price /room Double Room w/Breakfast
Hotel Category 1	1	180US	215US	190US	235US
Hotel Category 2	2	120-135US	130-160US	130-160US	140-190US
Hotel Category 3	3	140-180US	160-190US	160-200US	170-235US
Hotel Category 4	3	110-130US	110-130US	135-160US	145-160US
Hotel Category 5					
Other Accommod.					

### 12.3 Distance between the Airport / Railway Station and Hotels

Venue	Distance (km)	Timing (hrs)
Hotel Category 1	<0.5m	5mins walking
Hotel Category 2	0.5-1.5km	3-5mins
Hotel Category 3	5-8km	10mins
Hotel Category 4	~30km	25mins
Hotel Category 5		
Other Accommod.		

### 12.4 Distance between Hotels and Competition Venue

Venue	Distance (km)	Timing (hrs)
Hotel Category 1	<0.5m	5mins walking
Hotel Category 2	0.5-1.5km	3-5mins
Hotel Category 3	5-8km	10mins
Hotel Category 4	~30km	25mins
Hotel Category 5		
Other Accommod.		

### 12.5 Arrangement for Transportation of Delegations

Transport Description	Bus	Mini-Bus	Shuttle	Other	Price
From Airport/ Station to Hotels			✓		
From Hotels to Competition Venues			✓		
From Hotels to Training Venues			✓		

### 12.6 Arrangement for Transportation of Officials

Transport Description	Bus	Mini-Bus	Shuttle	Other	Price
From Airport/ Station to Hotels			✓		
From Hotels to Competition Venues			✓		

**13. Publicity and Promotion**

What publicity and promotion methods you plan to use:

- Advertisements on Radio
- Advertisements on TV
- Press conferences
- Street Posters and Bans
- Dedicated website/social media
- Other

Present details of the publicity and promotion plan:

- Outdoor advertising
- Advertising spaces at airport
- Public transport advertising spaces
- Accessible price for the ticketing  
(pending the support from the local sponsors)

**14. Tickets and Derived Products**

- How many tickets you expect to sell during the WC? 5,000
- What price of tickets you will apply? USD30

**15. Press Coverage**

Press coverage of the World Championship must be in line with the FIE Press Handbook.

**Do you herewith confirm that you are committed to implement the FIE Press Handbook?** YES  NO

**16. Television Coverage**

TV coverage of the World Championship must be in line with the FIE Television Handbook.

**Do you herewith confirm that you are committed to implement the FIE Television Handbook?** YES  NO

**16.1 Details of the Television Coverage Plan**

- National TV Channels
  - Live Broadcast  Number of Hours: 36
  - Recorded Broadcast  Number of Hours: 18
- Regional TV Channels
  - Live Broadcast  Number of Hours: 36
  - Recorded Broadcast  Number of Hours: 18
  - Other

Present details of the TV Coverage plan:

Live broadcast from all T8 to final and summary highlight after every competition day

---

## 17. Marketing plan

### 17.1 Details of the Marketing Plan

- TV Coverage
- Streaming from T32
- FIE and organizer website
- Rights to broadcast
- Local Media
- Website of the World Championships
- Social medial of the World Championships

17.2 Date when the complete Marketing Plan will be submitted to the FIE: September 2025

## 18. Sponsors

### 18.1 Sponsors Selection

Organising Committee cannot approach or make sponsorship arrangements with any company that is competitor with the major FIE sponsors.

**Do you herewith confirm that you will comply with presented criteria for selection of the sponsors?** YES  NO

**Do you herewith confirm that you are committed to implement Requirements that are specified in the FIE Press Handbook and the FIE Handbook of Regulations for WC?** YES  NO

18.2 Date when the complete List of Sponsors will be submitted to the FIE: September 2025

## 19. Protocol

The protocol ceremonies must be organised as specified in the FIE Handbook of Regulations for the Organization of Protocol Ceremonies at FIE Competitions.

The FIE Chief of Protocol coordinates with the LOC Protocol Manager to ensure that all elements of FIE protocol are respected.

**Do you herewith confirm that Protocol will be organised according to this FIE document?** YES  NO

## 20. Medical Service

Medical Service is to be provided in accordance for by the FIE Rules, the FIE Administrative Rules, the FIE Handbooks of Regulations and FIE Medical Handbook.

**Do you herewith confirm that you will comply organization of the Medical Service with the listed FIE Documents?** YES  NO

Medical Service is covering Medical Emergencies, Sports Trauma, General Medical Care and Additional Medical Services (Physiotherapy etc.).

Basic requirements are as follows

- Medical Stations, with locally licenced paramedic or doctor, must be present in competition halls, **MAXIMUM two (2) minutes away from the furthest hall**, and properly marked;
- Adequate ambulance must be present on site or **MAXIMUM at ten (10) minutes' drive distance**;
- Hospital with the emergency ward and facilities required for treatment of the possible injuries and illnesses must be selected and arrangements made for adequate support in case of emergency;

**Do you herewith confirm that you will meet Medical Service requirements?**

**YES**  **NO**

## **21. Doping Control**

According to the FIE Anti-Doping Rules, Doping Control tests are obligatory at all World Championships.

Testing process must be strictly managed according to the WADA regulations.

Doping Control Office (DCO) must be supplied by the National Anti-Doping Organization (NADO).

Analysis of the samples must be performed by the IOC accredited laboratory.

Coordinator of the doping control is the FIE Medical Delegate.

Doping Control station must be allocated as close as possible to the Finals venue, with all required facilities to accommodate limited access, privacy, preparation of the documentation, taking and processing samples.

Sample collection bottles, containers and forms are to be supplied the NADO.

**Do you herewith confirm that you will meet Doping Control requirements according to these regulations?** **YES**  **NO**

## **22. Security**

The Organizing Committee has to organise Security and Safety Service in order to provide:

- The health and physical security of all the participants;
- Safety of all the installed equipment;
- Regulation of access to various sites of the competition in line with the applied accreditation;
- No unauthorised access of the pistes and official rooms by the public;
- Good and safe circulation of people;

Also, discreet police service and the presence of a fire service is to be planned.

**Do you herewith confirm that you will meet presented Security requirements?**

**YES**  **NO**

## **23. Insurance**

The Organising Committee must, at its own costs, institute:

- Liability Insurance policy which will include general liability coverage, as well as a guarantee for non-consecutive intangible damages (pure financial loss).
- All other mandatory insurance, such as:



- ❖ Fire and fire damage insurance policies for premises necessary to the organisation
  - ❖ Automobile insurance policies (if necessary)
  - ❖ All policies mandated by local legislation.
- Repatriation Assistance coverage for the Fencing family, but without covering the designated officials or referees, the Executive Committee, or FIE personnel.

**Do you herewith confirm that you will meet presented Insurance requirements?**  
YES  NO

**24. Rewards for the Winners**

YES  NO

Present details of the planned Rewards for the Winners:  
Pending the negotiation with sponsors

**25. Cultural Programme Plan**

YES  NO

Present details of the Cultural Plan:  
Cultural and education fringe programme would be launched during the event period in the venue together with the environmental protection programme. The programme will promote the Olympic values in Hong Kong, as well as extending the opportunities of cultural discovery and exchanges to oversea visitors.

**26. Environmental Protection Plan**

YES  NO

Present details of the Environmental Protection Plan:  
HKFA would place major emphasis on cooperation and consultation with the government bodies, NGOs, other community organisations, the academic and private sectors specialised in the sustainability and environment-related field in order to maximise sustainability and reduce the environmental footprint.

First pillar of the strategy aims to achieve a carbon-neutral event by reducing energy and carbon emissions, using low-energy vehicles for all transportation.

A favourable environment is an essential element in achieving outstanding performance. At the same time, the joy and pleasure from sport, and the influence of role models and “proof by good example”, has the power to drive people to undertake concrete action. Therefore, progressing sustainability through sport will also be a pillar and a powerful and important principle for the championships. Various approaches including education, participation and collaboration will be promoted.



# 香港劍擊總會

## HONG KONG FENCING ASSOCIATION

### Letter of Commitment

The national federation of HONG KONG, CHINA

hereby bidding to the organisation of the World Championships of 2026

- 1) Hereby confirms that it has full knowledge of all its obligations and financial obligations to organise an FIE World Championships
  
- 2) Hereby confirms that it is committed:
  - a) to respect and implement the FIE Statutes, including articles 1.2.4 and 1.2.5, the FIE Ethics and Safeguarding codes, the FIE rules, the FIE Administrative Rules, the FIE handbook of regulations, FIE Protocol handbook and any FIE rule in force.
  
  - b) to respect Its financial obligations
  
- 3) confirms that it has received from its national authorities a written agreement guaranteeing the granting of visas to all the participants of the member national federations of the FIE.

23 August 2023  
Hong Kong, China

  
Yeung Win Sun A.N.W  
Chairman





## Proposals for the 2023 Congress

### Modifications of the Statutes

The texts below are applicable on January 1st, 2024, unless mentioned otherwise.

---

**Article:** 3.1. Introduce real-time streaming from the FIE Congress

P.1

**Proposal from:** Swedish Fencing Federation

**Motivation:** The purpose of this proposal is to increase the transparency of the FIE Congress procedures. The discussions and the decisions of the Congress are of interest to fencers, coaches and fencing volunteers around the world. It is also of importance that the decision-making process of the FIE is transparent to media to the largest possible extent.

#### 3.1 MEETINGS

f) The proceedings of every Congress must be transmitted live (video and sound) via the Internet and the link to the transmission made publicly available on the FIE web-site before the start of the Congress.

**Legal Commission:** Not in favour of the proposition.

There are no legal reasons for this requirement, it is not necessary for transparency as the congress report is published later in the year and it is contentious in terms of outside pressures, of the implications for congress attendees of unwanted social media attention.

**Opinion of the Executive Committee:** Agrees with the opinion and arguments of the Legal Commission. Not in favour of the proposal as the current process is fully transparent:

- the documentation for the Congress is issued in 3 languages, sent to NFs and published on the FIE website.
- the list of decisions of the Congress is issued in 3 languages, sent to NFs and published on the FIE website.
- the verbatim report of the Congress is issued in 3 languages, sent to NFs and published on the FIE website.

**Article: 3.3 and 4.1****Proposal from: Legal Commission**

**Motivation:** To allow candidates for commissions and the Ethics Committee to attend Elective Congresses.

**3.3 COMPOSITION AND REPRESENTATION**

3.3.1 The FIE member Federations may be represented at a FIE Congress by 2 delegates, ~~whose names must be made known to the FIE Head Office one month before the Congress in writing~~. Members of the Executive Committee, the Commissions, ~~and~~ the permanent councils ("Councils") ~~and of the Ethics Committee~~ have the right to take part in the Congress.

At FIE Elective Congresses, the FIE member Federations may be represented by 2 delegates. Members of the Executive Committee and candidates to elected positions have the right to take part in the FIE Elective Congresses.

All participants in the FIE Congresses must be registered by their national federation, 40 calendar days before the opening day of the Congress and using the platform or tool that will be made available by the FIE.

**4.1 GENERAL RULES**

4.1.2 Candidates for the Executive Committee, a Commission, a Council, the Ethics Committee or the Disciplinary Panel may be proposed by an FIE Member Federation, subject to the following conditions ~~and requirements~~:

- only one candidate may be proposed by each Member Federation for each post
- a candidate can only be presented by the Member Federation (treated in 4.4.1, 4.6.2 and 4.7.1) whom the candidate has nationality.

~~4.1.3~~ - ~~A~~ all the candidatures ~~must be received on the FIE platform or tool shall reach the FIE Head Office~~ no later than 00:00 hrs Lausanne time ~~40~~ 50 calendar days before the opening day of the Elective Congress.

- ~~¶~~ the candidatures submitted on the FIE platform or tool must include a CV (maximum length of one page of A4 format) ~~stating must be presented by means of a form provided by the FIE (one single page of A4 format) which must include~~ the languages spoken as well as the degrees or other qualifications for the particular ~~position commission~~. A photocopy of an identity document stating the candidate's date of birth and nationality (passport, identity card, driving licence) must be provided with the candidature.

4.1.3 The ~~administrative office of the FIE will include the~~ list of all the candidates as well as the CVs that have been received ~~will be included~~ in the documents relating to the Congress.

4.1.4 The FIE Bureau rejects candidatures which do not respect the FIE Statutes or the IOC Code of Ethics. Each national federation can contest the list of the candidates communicated by the Bureau. All questions will in the last instance be considered by the Executive Committee, after advice from the Legal Commission and the persons concerned. In case of urgency an opinion can be obtained by fax or e-mail.

**Legal Commission:** In favour of the proposition.

The Commission would like to add the attendance of presidents of commissions, councils and committees, so that paragraph 2 of the proposal would read (added words highlighted in yellow):-

At FIE Elective Congresses, the FIE member Federations may be represented by 2 delegates. Members of the Executive Committee, presidents of commissions, councils and committees and candidates to elected positions have the right to take part in the FIE Elective Congresses.

The commission considers that as the congress might discuss matters relating to the work of these bodies their presidents should have the right to be present to represent them and to assist the Congress better to understand the topic concerned.

**Opinion of the Executive Committee:** In favour of the modifications in paragraphs 1 and 3 of article 3.3.1. Paragraph 2 of 3.3.1 is reviewed as follows for the sake of clarity:

At FIE Elective Congresses, the FIE member Federations may be represented by 2 delegates. In addition, the following individuals have the right to take part in the FIE Elective Congresses:

- current members of the Executive Committee
- current presidents of commissions, councils and committees
- candidates to elected positions

In favour of 4.1, 4.1.2, 4.1.3 and 4.1.4.

**Article: 4.4.2****Proposal from: Legal Commission****Motivation:** Refine the conditions for candidature for election to The Medical Commission

4.4.2 To be candidate for a permanent commission or the Ethics Committee a person must hold a licence from his National Federation except if he is a Member of Honour, be at least 21 years of age on the date of the elections and enjoy the full civic rights of the country to which he belongs.

~~It is desirable that the candidates for various Commissions have specific professional knowledge or credentials as follows:~~

A candidate for the Medical Commission - must have completed the educational requirements for being an MD, DO or DC or have practiced as a physiotherapist, or have been a member of the Commission for at least 8 years.

**Medical Commission: Not in favour.**

The core issue of discussion pertains to the expansion of criteria for Medical Commission Member candidates to include Doctors of Osteopathy (DO) and Doctors of Chiropractic (DC) proposed by the Legal Commission. While the proposal was rejected by the majority of the Medical Commission with a vote of 8-2, the dissenting and advocacy votes raised significant points that merit further consideration.

**Legal Commission: In favour** of the proposition.

The Commission however proposes the modification of the proposition as follows:-

A candidate for the Medical Commission - must have completed the educational requirements for being an MD, DO or DC ~~or have practiced as a physiotherapist, or have been a member of the Commission for at least 8 years~~ and hold a valid and active licence, or be qualified and be practicing as a physiotherapist.

The Commission considers that to ensure they maintain their knowledge and skills up to date through continuous professional development it is necessary that its members are currently qualified to practice, and that therefore the clause in the following propositions accepting previous membership of the commission as a criterion for candidature, in order to benefit from their experience, is not appropriate.

**Opinion of the Executive Committee:** In favour of the deletion of the sentence below and in favour of the revised proposal below:

~~It is desirable that the candidates for various Commissions have specific professional knowledge or credentials as follows:~~

A candidate for the Medical Commission - must have completed the educational requirements for being an MD, DO or DC ~~or have practiced~~ and hold a valid and active licence, or be qualified and be practicing as a physiotherapist or have been a member of this Commission for at least two mandates.

---

**Article: 4.4.2**

P.4

**Proposal from: Legal Commission**

**Motivation:** Refine the conditions for candidature for election to the Legal Commission

4.4.2 To be candidate for a permanent commission or the Ethics Committee a person must hold a licence from his National Federation except if he is a Member of Honour, be at least 21 years of age on the date of the elections and enjoy the full civic rights of the country to which he belongs.

~~It is desirable that the candidates for various Commissions have specific professional knowledge or credentials as follows:~~

A candidate for the Legal Commission — must have the educational requirements or ~~be practising~~ have practiced as a lawyer, judge or notary or have been a member of the Commission for at least 8 years;

**Legal Commission:** In favour of the proposition.

The Commission however proposes to change ‘the’ to ‘this’, for the sake of clarity, and delete the last 4 words (for at least 8 years), as unnecessary, so as to read:-

A candidate for the Legal Commission — must have the educational requirements or ~~be practising~~ have practiced as a lawyer, judge or notary or have been a member of this Commission.

**Opinion of the Executive Committee:** In favour of the deletion of the sentence below and in favour of the following:

~~It is desirable that the candidates for various Commissions have specific professional knowledge or credentials as follows:~~

A candidate for the Legal Commission — must have the educational requirements or ~~be practising~~ have practiced as a lawyer, judge or notary or have been a member of this Commission for at least two mandates;

---

**Article: 4.4.2**

P.5

**Proposal from: Legal Commission**

**Motivation:** introduce conditions for candidature for election to the Promotion, Communication and Marketing commission

4.4.2 To be candidate for a permanent commission or the Ethics Committee a person must hold a licence from his National Federation except if he is a Member of Honour, be at least 21 years of age on the date of the elections and enjoy the full civic rights of the country to which he belongs.

A candidate for the Promotion, Communication and Marketing Commission must have a college or university degree in marketing or communications and have held a management position in marketing or communications or have been the producer of films, or have been a member of the Commission for at least 8 years.

**PCM Commission: Proposed text:**

A candidate for the Promotion, Communication and Marketing Commission must:

- have a college or university degree in Marketing, Communications or Media
- or have professional experience in Marketing, Communications or Media
- or have been a member of the Commission for at least 4 years.

**Legal Commission: In favour** of the proposition.

The Commission however proposes to change 'the' to 'this', for the sake of clarity, delete the last 4 words (for at least 8 years), as unnecessary, so as to read:-

A candidate for the Promotion, Communication and Marketing Commission must have a college or university degree in marketing or communications and have held a management position in marketing or communications or have been the producer of films, or have been a member of **this** Commission.

**Opinion of the Executive Committee:** In favour of the following:

A candidate for the Promotion, Communication and Marketing Commission must:

- have a college or university degree in Marketing, Communications or Media
- or have professional experience in Marketing, Communications or Media
- or have been a member of this Commission for at least **two mandates**.

---

**Article: 4.4.2**  
**Proposal from: Legal Commission**

**P.6**

**Motivation:** Refine the conditions for candidature for election to the Refereeing Commission

A candidate for the Refereeing Commission must:

- be or have been an FIE category B or A referees in at least two weapons; and
- be a current member **or have already been a member** of the Refereeing Commission, or have refereed in official FIE competitions in at least two weapons in at least two (2) of the 4 fencing seasons (1 September to 31 August) preceding his candidature; and
- have refereed, at least once, in one weapon, in the table of **32/16** or eight **or** semi-final



or final of the individual or team event of a senior World Cup, or a Grand Prix, or a World Championships or the Olympic Games of the 4 fencing seasons preceding his candidature **or have been part of the master list**.

Being a member of the Refereeing Commission is incompatible with the national roles of technical director, referee, chief of delegation and team captain, **President, Secretary General or member of the governing body of a National Federation**. Once elected, the Refereeing Commission member shall send to the FIE head-office a letter of commitment signed by both the Refereeing Commission member and his/her national federation.

**Refereeing Commission:** Not in favour.

**Legal Commission:** In favour of the first half of the proposition (up to “been part of the master list”). The commission proposes however to replace “have refereed, at least once, in one weapon, in the table of **32/16 or eight...** etc” by “have refereed, at least once, in one weapon, in the table of **16 or eight .....** etc”.

Not in favour of the second part modifications (“Being a member ..... National Federation” as being too wide-ranging and potentially penalizing smaller federations where members fulfill multiple roles:-

A candidate for the Refereeing Commission must:

- be or have been an FIE category B or A referees in at least two weapons; and
- be a current member **or have already been a member** of the Refereeing Commission, or have refereed in official FIE competitions in at least two weapons in at least two (2) of the 4 fencing seasons (1 September to 31 August) preceding his candidature; and
- have refereed, at least once, in one weapon, in the table of **16 or eight or semi-final or final** of the individual or team event of a senior World Cup, or a Grand Prix, or a World Championships or the Olympic Games of the 4 fencing seasons preceding his candidature **or have been part of the master list**.

Once elected, the Refereeing Commission member shall send to the FIE head-office a letter of commitment signed by both the Refereeing Commission member and his/her national federation

**Opinion of the Executive Committee:** In favour of the following:

A candidate for the Refereeing Commission must:

- be or have been an FIE category B or A referees in at least two weapons; and
- be a current member **or have been a member for at least two mandates** of the Refereeing Commission, or have refereed in official FIE competitions in at least two weapons in at least two (2) of the 4 fencing seasons (1 September to 31 August) preceding his candidature; and
- have refereed, at least once, in one weapon, in the table of eight **or semi-final or final** of the individual or team event of a senior World Cup, or a Grand Prix, or a World Championships or the Olympic Games of the 4 fencing seasons preceding his candidature.

**Article: 4.4.2**

P.7

**Proposal from: Legal Commission**

**Motivation:** Introduce conditions for candidature for election to the Rules Commission

4.4.2 To be candidate for a permanent commission or the Ethics Committee a person must hold a licence from his National Federation except if he is a Member of Honour, be at least 21 years of age on the date of the elections and enjoy the full civic rights of the country to which he belongs.

A candidate for the Rules Commission must have been an active 'A' or 'B' rated referee or have officiated, at least twice, as a president of the DT at a Zonal Championship or as a member of the DT at a World Championship or as a member of the DT at an Olympic Games, or have been a member of the Commission for at least 8 years.

**Rules Commission:** Not in favour. The limitations are not necessary. The competence and the attitude should prevail on previous experience.

**Legal Commission:** In favour of the proposition. The Commission however proposes to change 'the' to 'this', for the sake of clarity, and delete the last 4 words (for at least 8 years), as unnecessary, so as to read:-

A candidate for the Rules Commission must have been an active 'A' or 'B' rated referee or have officiated, at least twice, as a president of the DT at a Zonal Championship or as a member of the DT at a World Championship or as a member of the DT at an Olympic Games, or have been a member of this Commission.

**Opinion of the Executive Committee:** In favour of the following:

A candidate for the Rules Commission must have been an 'A' or 'B' rated referee or have officiated, at least twice, as a president of the DT at a Zonal Championship or as a member of the DT at a World Championship or as a member of the DT at an Olympic Games, or have been a member of this Commission for at least two mandates.

---

**Article: 4.4.2**

P.8

**Proposal from: Legal Commission**

**Motivation:** Refine the conditions for candidature for election to the SEMI Commission

4.4.2 To be candidate for a permanent commission or the Ethics Committee a person must hold a licence from his National Federation except if he is a Member of Honour, be at least 21 years of age on the date of the elections and enjoy the full civic rights of the country to which he belongs.

~~It is desirable that the candidates for various Commissions have specific professional knowledge or credentials as follows:~~

A candidate for the - SEMI Commission must have a college degree in engineering or science or be practising as an engineer or have been a member of the Commission for at least 8 years.

**SEMI Commission:** In favour with the follow amendments:

The SEMI Commission will set selection criteria and development opportunities.

A candidate for the - SEMI Commission must have a college degree in engineering or science or a subject relating to the work of the SEMI, be practising as an engineer or have been a member of the Commission for at least 8 years, or hold a qualification recognised by the SEMI Commission in Armoury work.

**Legal Commission:** In favour of the proposition. The commission would like to modify the text of the proposition by changing 'the' to 'this', for the sake of clarity, deleting its last four words (for at least 8 years), and adding an additional paragraph ('Be a member or ....') as follows:-

A candidate for the SEMI Commission must have a college degree in engineering or science or be practising as an engineer or have been a member of this Commission, and

Be a member or have already been a member of the SEMI Commission of a National Federation or fulfilled an equivalent role, or have officiated at least twice at weapon control or as a technician at Zonal Championship or a World Championship or an Olympic Games.

*The commission notes the risk of candidates for the commission having all the academic qualifications required but no experience of the sport of fencing and therefore of practical fencing-related applications, and therefore proposes this additional second paragraph.*

**Opinion of the Executive Committee:** In favour of the deletion of the sentence below and in favour of the following:

~~It is desirable that the candidates for various Commissions have specific professional knowledge or credentials as follows:~~

A candidate for the SEMI Commission must have a college degree in engineering or science in a subject relating to the work of the SEMI Commission, or be practising as an engineer or have been a member of this Commission for at least two mandates.

---

**Article:** 4.5

**Proposal from:** FIE Executive Committee

P.9

## **Motivation:**

- increase the number of elected athletes in relation to the number of nominated athletes (IOC guideline)
- take into account the possible change of the year of the Olympic Games
- adaptation of the voting system (electronic voting, scan of the accreditation)
- clarifications

## **4.5 ELECTION OF THE ATHLETES COMMISSION.**

- 4.5.1 The elections for the Athletes Commission are held at the **Open Senior** World Championships in the year following the Olympic Games.
- 4.5.2 All athletes who, in the weapon in which they fence, have been entered to compete in either one of the last two Olympic Games or at least one of the **Open Senior** World Championships held over the last 5 years can be a candidate for the Athletes Commission.
- If the fencer has fenced several weapons during such competitions, he must choose only one of those weapons for this candidature.
- Each member federation can nominate one single athlete ~~for~~ **to** the Athletes Commission
- 4.5.3 Each member federation shall indicate to the FIE the name of its candidate two months before the first day of the **Open Senior** World Championships in the year following the Olympic Games.
- 4.5.4 One month before the **Senior** World Championships, the FIE shall send to each member federation the list of the candidates.
- 4.5.5 The athletes who will participate in the **Open Senior** World Championships in the year following the Olympic Games will elect ~~six~~ **seven** representatives (always among the athletes nominated by the member Federations) ~~for a four year term~~.
- 4.5.6 A list of candidates will be established, all weapons combined, and each participant shall vote for ~~6~~ **seven** athletes maximum, whatever weapon the athletes are applying for.
- 4.5.7 The voting athletes will personally go to the **voting** office of the FIE at the competition site **in order to proceed with the vote** ~~to fill in their voting slip and deposit them in the ballot box~~, after having verified their identity by presenting their accreditation.
- The athlete's accreditation will be scanned or the athlete will sign and having signed** the attendance sheet.
- 4.5.8 **Voting may be conducted electronically. If the vote is not organised by electronic means but by means of paper ballots, o**ne single ballot box will be provided for all weapons.
- 4.5.9 The voting will be open for all weapons and will begin on the first day of the **Senior** World Championships and will end at noon local time on the last day of the World Championships.

- 4.5.10 The **seven** candidates who have received the greatest number of votes will be elected, without distinction of weapon.
- 4.5.11 In case of a tie, the candidate who has the highest placing in the world Open ranking on the date of the opening of the **Open Senior** World Championships will have the preference.
- 4.5.12 The Executive Committee, at its first meeting after these **Open-Senior** World Championships, will nominate up to **6 five** athletes among the list of athletes submitted by their national federations. ~~The athletes are nominated for a four year term.~~ If the submitted candidacies allow it, all 6 weapons and four zones – Europe, America, Africa and Asia/Oceania – must be represented within the commission.
- 4.5.13 The federations will be informed of the result of the athletes' votes at the closing ceremony of the **Open Senior** World Championships. ~~and t~~The complete list of **elected and appointed athletes names** will be **sent to the federations provided by the Executive Committee** with as little delay as possible.
- 4.5.14 The Athletes' Commission thus formed shall remain in office until the Senior World Championships held after the next Olympic Games.

**Legal Commission:** In favour.

**Athletes' Commission:** In favour.

**Opinion of the Executive Committee:** In favour of the proposal.

Application: next elections of the Athletes Commission (2025).

---

**Article:** 4.4 and 6.9

**Proposal from:** Legal Commission

P.10

**(Deferred proposal from Congress 2022)**

**Motivation:** To bring the Committee into line with the Commissions, to increase its availability to both ensure the FIE's observance of its Code of Ethics and to provide a viable quorum of neutral members when required.

#### 4.4 ELECTION OF COMMISSIONS (OTHER THAN THE ATHLETES COMMISSION) AND THE ETHICS COMMITTEE

- 4.4.3 a) For the elections to the permanent commissions **and the Ethics Committee**, the 10 candidates with the most votes are elected subject to the fact that they must be of different nationalities.

~~b) For the election to the Ethics Committee, the 5 candidates with the most votes are elected subject to the fact that they must be of different nationalities.~~

4.4.4 a) If the 10 candidates to a Commission or the Ethics Committee who have obtained the most votes do not include at least 3 persons of each gender, the Commission will consist of the 3 candidates of the under-represented gender who have obtained the greatest number of votes and the 7 candidates of the other gender who have obtained the greatest number of votes.

~~b) For the Ethics Committee, if the 5 members who have obtained the most votes do not include at least 2 persons of each gender, the Committee will consist of 2 candidates of the under-represented gender who have obtained the greatest number of votes and 3 candidates of the other gender who have obtained the greatest number of votes~~

## 6.9 THE ETHICS COMMITTEE

The Ethics Committee is made up of five ten voting members elected by the Congress.

**Legal Commission:** In favour.

**Ethics Committee:**

**Opinion of the Executive Committee:** In favour of the proposals in 4.4.3, 4.4.4 and 6.9.

P.11

### Article: 5.2.1

#### Proposal from: National Fencing Federation of Kazakhstan

**Motivation:** Our federation regularly reads and continues to study the Statutes of the FIE. We are also reviewing modern conditions of the development of the Fencing world.

In this regard, the Kazakhstan Fencing Federation would like to inform you that in Chapter V. EXECUTIVE COMMITTEE, in paragraph 5.2 STRUCTURE OF EXECUTIVE COMMITTEE, contains paragraph 5.2.1. which does not include all members of the executive committee of the FIE, and thus automatically limits the rights of a certain number of full members of the executive committee in the right of appointment or selection for certain positions, for example: the appointment as Secretary General or Treasurer, or in the election for the position of three vice presidents of the FIE. However, the FIE executive committee currently consists of 22 full members (see paragraph 5.2.4 and paragraph 5.2.5.)

a) To revise article 5.2.1 as follows, and to remove articles 5.2.4 and 5.2.5:

The Executive Committee consists of the following members with full rights including voting rights: the President ~~on the one hand, and~~, fifteen elected members ~~on the other~~, the President in office of each of the five geographic zones and the President in office of the Athletes Commission.

The five geographic zones are the following: Africa, America, Asia, Europe and Oceania.

b) To remove article 5.2.4

~~The President in office of each of the five geographic zones is an ex-officio member with full rights of the Executive Committee of the FIE. As such, he has the right to vote. The five zones are the following: Africa, America, Asia, Europe and Oceania.~~

c) To remove article 5.2.5

~~The President in office of the Athletes Commission is a member of the FIE Executive Committee with full rights and obligations. As such, he/she has the right to vote.~~

**Legal Commission:** Not in favour.

The proposal would allow a president of a confederation or the president of the athletes' commission to become secretary general, secretary-treasurer or a vice president of the FIE. But these persons' situation in the Executive committee is different from that of the other members, in that they have been elected to that position by a body other than the Elective Congress of the FIE and therefore do not carry the mandate of all the FIE members. They are also likely to perceive their role as representing the interests of their confederation or the athletes rather than the whole FIE; and at a practical level the workload of a confederation president is incompatible with taking on the heavy burden of FIE secretary general or secretary-treasurer.

**Opinion of the Executive Committee:** Not in favour.

The proposal has been withdrawn.

---

**Article:** Chapter 13

P.12

**Proposal from:** Women and Fencing Council

**Motivation:** The FIE statutes already include expectations on National Federations in relation to sport integrity for example:

***Betting and Anti Corruption: 2.5 It is recommended that Member Federations and Confederations put in place similar rules and regulations to safeguard the integrity of competitions held under their respective jurisdictions.***

The proposal is to extend Safeguarding recommendations in a similar way so that the expectations of the FIE are clear.

**Chapter 13**

(add at end):

It is recommended that Member Federations and Confederations develop and implement similar policies and procedures to safeguard and promote the welfare of all participants in fencing activity held under their respective jurisdictions.

**Women and Fencing Council:** Agreed.

**Legal Commission:** In favour.

**Opinion of the Executive Committee:** In favour of the proposal.

---

**Article:** Chapter 13

P.13

**Proposal from:** Women and Fencing Council

**Motivation:** For the protection of all participants,

1. Extend the requirement for a Safeguarding Officer role to the Zonal Championships.
2. Ensure that unresolved safeguarding reports are reported to the FIE.

### **Chapter 13**

During the Junior/Cadet and Senior and Veterans World Championships, incidents of harassment/abuse/neglect can be reported to the FIE Safeguarding Officer on site.

During Open World Cups and Junior World Cups, incidents of harassment/abuse/neglect can be reported to the FIE Supervisor, acting as the FIE Safeguarding officer. This responsibility shall be added to the list of responsibilities of Supervisors.

The FIE shall designate Safeguarding Officers to other official FIE events, for example, training camps.

The FIE shall ensure that the FIE Safeguarding Officers receive appropriate training and support for carrying out their responsibilities under this policy.

Zonal Confederations shall appoint at least one person to serve as a Safeguarding Officer at each Zonal Championship. All safeguarding reports which are not resolved through mediation must be reported to the FIE.

**Women and Fencing Council:** Agreed.

**Legal Commission:** In favour. The commission would however like to modify the text of the proposition by adding the clause highlighted in yellow as follows:

Zonal Confederations shall appoint at least one person to serve as a Safeguarding Officer at each Zonal Championship. All safeguarding reports which are not resolved through mediation must be reported to the FIE **in accordance with the underlying safeguarding rules of the FIE.**



The commission asks for this addition to help ensure the confidentiality of such reports.

**Opinion of the Executive Committee:** In favour of the proposal as revised by the Legal Commission.

---



**Proposals for the 2023 Congress**  
**Modifications of the Organisation Rules**

The texts below are applicable on January 1st, 2024, unless mentioned otherwise.

---

**Article:** o.10

P. 1

**Proposal from:** Women and Fencing Council

**Motivation:**

Advance gender equality in Organising Committees, to assist in the development of more females in all roles in fencing and to ensure that both genders have representation.

Demonstrate the FIE's commitment to the IOC objective to advance gender equality in all aspects of Olympic sport and help ensure that the FIE meet the gender representation quotas for participation in the Olympics.

**o.10**

- 1 The Organising Committee is the group of persons responsible for organising the competition.
- 2 The Organising Committee must take note of the instructions in the Specifications ('Cahier des Charges') specific to each category of competition.
3. The Organising Committee is expected to have representation of both genders.

**Women and Fencing Council:** In favour

**Rules Commission:** Not in favour. The matter is already covered by the Administrative Rules.

There's nothing in our statutes or administrative rules to indicate that a council can make direct proposals for modifications in the rules (Statute 6A.5.3).

The function of councils is to suggest solutions to the Executive Committee to promote the objectives indicated in the statutes.

**Opinion of the Executive Committee:** In favour as follows:

- 1 The Organising Committee is the group of persons responsible for organising the competition.
- 2 The Organising Committee must take note of the instructions in the Specifications ('Cahier des Charges') specific to each category of competition.
3. If possible, both genders should be represented in the Organising Committee.

P. 2

**Article:** o.15 and o.85

**Proposal from:** Rules Commission

**Motivation:** Group the procedure for uploading and publishing registration files o.85.1 in o.15.5. This proposal concerns the procedure and the responsibility of the DT.

*FIE Directoire Technique and delegates for official events*

**o.15**

- 5 The day before an individual or team competition, the DT must download the entry file, the day before the competition, from 12:00 noon local time from the FIE website.
  - In individual competitions, the DT must publish and send to the FIE the pools and the relevant schedules, as well as the list of exempt fencers for senior competitions, no later than 4:00 p.m. (local time). No addition may be made to pools already published unless they come from pools starting at the same time (cf o.67.1).
  - In team competitions, the DT must publish and send to the FIE the table and the relevant schedules no later than one hour after the end of the quarter finals of the individual event. No addition may be made to the published list.

**o.85**

- 1 The competition consists of **two phases**, a preliminary phase and a main phase, each of which are run on one day.
- ~~2 — The day before the competition, the organizers must publish and send to the FIE the pools and relevant schedules, as well as the list of exempt fencers, at the latest by 4:00 pm (local time). To do so, they must download the entry file from the FIE web site the day before the competition at or after 12h00, local time. No addition may be made to pools already published unless they come from pools starting at the same time (cf o.67.1).~~

**3 2** The **16 fencers entered who are ranked highest in the most recent official FIE classification** are exempt from the preliminary phase.

**4 3** Should a fencer who has been entered not turn up, a fine (cf o.31, table of financial penalties and fines), payable to the FIE, is inflicted on the Federation of the fencer at fault except in a case of force majeure which is duly justified.

**5 4** In the case of a tie in the official FIE ranking between two or more fencers for the 16th exempt place, lots are drawn to decide which of these fencers will benefit from exemption from the preliminary phase.

**SEMI Commission:** In favour.

**Rules Commission:** In favour.

**Opinion of the Executive Committee:** In favour of the proposal.

---

**Article:** o.16

P. 3

**Proposal from:** Women and Fencing Council

**Motivation:**

Advance gender equality in the Directoire Technique, to assist in the development of more females in all roles in fencing and to ensure that both genders have representation.

Demonstrate the FIE's commitment to the IOC objective to advance gender equality in all aspects of Olympic sport and help ensure that the FIE are able to meet the gender representation quotas for participation in the Olympics.

**o.16**

Nomination of the Directoire Technique

The **Directoire Technique** is composed of people **who have the experience and competence to organise competitions.**

1 *World Championships and Olympic Games.*

- a) **For the Olympic Games** the Directoire Technique is composed of **six** members of different nationalities, one of whom must represent the country where the competition is held. **There must be at least one member from each gender.**

- b) **For the World Championships**, the Directoire Technique is composed of **8** members of different nationalities, one of whom must represent the organising country. **There must be at least two members from each gender.**

2 *World Cup and Grands Prix competitions.*

The Directoire Technique is composed of three qualified persons from the country where the competition is held or invited by them. **There must be at least one member from each gender.**

3 *Veterans World Championships*

The Directoire Technique is composed of four members of different nationalities, one of whom must represent the country where the competition is held. **There must be at least one member from each gender.**

**Women and Fencing Council:** In favour.

**Veterans Council:** In favour.

**Rules Commission:** Not in favour. The matter is already covered by the Administrative Rules.

**Opinion of the Executive Committee:** In favour of the proposal.

---

**Article:** o.18

P. 4

**Proposal from:** Women and Fencing Council

**Motivation:**

Advance gender equality in refereeing, SEMI and medical delegates, to assist in the development of more females in all roles in fencing and to ensure that both genders have representation.

Demonstrate the FIE's commitment to the IOC objective to advance gender equality in all aspects of Olympic sport and help ensure that the FIE are able to meet the gender representation quotas for participation in the Olympics.

**o.18**

Designation of refereeing, SEMI, and medical delegates

Refereeing delegates must be members of the FIE Refereeing Commission. SEMI delegates must be members of the FIE SEMI Commission.

Medical delegates must be **a** members of the FIE Medical Commission.

1. World Championships

A chief Refereeing delegate and 5 more Refereeing delegates, a chief SEMI delegate and 2 more SEMI delegates and 3 Medical delegates are appointed by the FIE Executive Committee following the recommendations of the respective commissions. **Across all the delegates there must be at least 30% of Refereeing delegates and at least one of SEMI and medical delegates from each gender.**

#### 2. Grands Prix

Two Refereeing delegates are appointed by the Executive Committee following the recommendation of the Refereeing Commission. **There must be a minimum representation of at least 20% of each gender when all Grand Prix appointments across all weapons are considered together.**

#### 3. Senior World Cup competitions

One Refereeing delegate is appointed by the Executive Committee following the recommendation of the Refereeing Commission. **There must be a minimum representation of at least 20% of each gender when all Senior World Cup appointments across all weapons are considered together.**

#### 4. Veterans World Championships

Two Refereeing delegates, one SEMI delegate and two Medical delegates are appointed by the FIE Executive Committee following the recommendations of the respective commissions. **There must be at least one delegate from each gender within the total of 5 appointments.**

**Rules Commission:** In favour.

**Medical Commission:** In favour, with one decent - In principle, they agree, but cannot be a rule. It can make a lot of problems with scheduling.

**Refereeing Commission:** Not in favour.

**SEMI Commission:** In favour. In view of the increase in size of the Veteran World Championships a second SEMI Delegate should be appointed and consideration also be given to a SEMI Delegate for Grand Prix events.

**Veterans Council:** In favour.

**Women and Fencing Council:** Agreed as amended.

### **o.18**

Designation of refereeing, SEMI, and medical delegates

Refereeing delegates must be members of the FIE Refereeing Commission. SEMI delegates must be members of the FIE SEMI Commission.

Medical delegates must be a members of the FIE Medical Commission.

**When all delegate designations are taken together (across all types of competitions and all weapons in one season) there must be a minimum of 20% representation of both genders. There must be at least one delegate of each gender from each of the Refereeing, SEMI and Medical Commissions designated at World Championships, except Veteran World Championships, where of the 5 designated delegates there must be at least one of each gender.**

#### 1. World Championships

A chief Refereeing delegate and 5 more Refereeing delegates, a chief SEMI delegate and 2 more SEMI delegates and 3 Medical delegates are appointed by the FIE Executive Committee following

the recommendations of the respective commissions. **Across all the delegates there must be at least 30% of Refereeing delegates and at least one of SEMI and medical delegates from each gender.**

#### 2. Grands Prix

Two Refereeing delegates are appointed by the Executive Committee following the recommendation of the Refereeing Commission. **There must be a minimum representation of at least 20% of each gender when all Grand Prix appointments across all weapons are considered together.**

#### 3. Senior World Cup competitions

One Refereeing delegate is appointed by the Executive Committee following the recommendation of the Refereeing Commission. **There must be a minimum representation of at least 20% of each gender when all Senior World Cup appointments across all weapons are considered together.**

#### 4. Veterans World Championships

Two Refereeing delegates, one SEMI delegate and two Medical delegates are appointed by the FIE Executive Committee following the recommendations of the respective commissions. **There must be at least one delegate from each gender within the total of 5 appointments.**

**Opinion of the Executive Committee:** The delegates proposed by the commissions are based on the availability of these delegates to the different competitions. For the Refereeing delegates, additional criteria should also be taken into consideration, such as the weapons specialty of each member and continental representation. In addition, for the Veterans World Championships, article o.50.2 mentions that “*The officials a) to e) should preferably be selected from the Zone in which the Championships are being held.*”

Therefore, the Executive Committee is in favour of the following revised proposal:

When all delegate designations are taken together (across all types of competitions and all weapons in one season) there must be a minimum of 20% representation of both genders, **should the availability of the delegates and continental representation allow it.** **Should the availability of the delegates and continental representation allow it,** there must be at least one delegate of each gender from each of the Refereeing, SEMI and Medical Commissions designated at World Championships. **For the Veteran World Championships, of the 5 designated delegates there must be at least one of each gender, if the availability of the delegates and continental representation allow it.**

---

**Article:** **o.25.3**

**Proposal from:** Women and Fencing Council

**Motivation:**

To assist in the FIE gaining better understanding of the numbers of female referees.

**o.25.3**

3 In addition, the organising committee of junior World Cup competitions and satellite competitions is required to monitor and report on gender diversity of the registered referees.

P. 5

**Refereeing Commission:** Not in favour.

**Rules Commission:** Not in favour. The data is available in the results of the competitions.

**Women and Fencing Council:** Agreed as amended:

### **o.25.3**

3 In addition, the FIE Supervisor or President of the Directoire Technique **organising committee** of junior World Cup competitions and satellite competitions is required to monitor and report on gender diversity of the registered referees. Reporting will be done through the FIE Supervisor's report.

**Opinion of the Executive Committee:** Referees at these competitions are selected and brought by participating delegations (if required by o.25 of the Rules) or hired by the organising federations if not enough referees are brought by delegations (which is sometimes known only 7 days before the competitions). Therefore, the organising committees are not able to monitor gender diversity of the referees. In addition, most of the time, there is no supervisor in satellite competitions, and therefore there is no supervisors' report. Therefore, in favour of the following revised proposal:

3 In addition, the FIE Supervisor of junior World Cup competitions is required to report on gender diversity of the registered referees through the FIE Supervisor's report.

---

**Article:** **o.26**

P. 6

**Proposal from:** Women and Fencing Council

### **Motivation:**

Advance gender equality in refereeing, to assist in the development of more females in all roles in fencing and to ensure that both genders have representation.

Demonstrate the FIE's commitment to the IOC objective to advance gender equality in all aspects of Olympic sport and help ensure that the FIE are able to meet the gender representation quotas for participation in the Olympics.

Where it is not possible to meet minimum expectations then written reports will assist in exploring solutions.

### **o.26**

- 1 Refereeing at Veteran World Championships is carried out by referees appointed by the Executive Committee of the FIE, selected by the Refereeing Commission on indication of the Organizing Committee and Veterans Council. **There must be a minimum representation of at least 30% of each gender across all such appointments.** Referees must attend the refereeing meeting that takes place the day before the World Championships.
- 2 For **Senior World Cup, Grands Prix and World Cup team competitions**, 8 referees, proposed by the Refereeing Commission, will be designated by the Executive



Committee and delegations will not have to provide any referees. There must be a minimum of one person from each gender, if possible. If this is not possible a written explanation must be provided to the FIE.

The additional referees required (not less than 5) will be provided by the organising committee. **All the referees will be at the expense of the organisers who in return will keep the entry fees.** There must be a minimum of one person from each gender, if possible. If this is not possible a written explanation must be provided to the FIE.

**Rules Commission:** Not in favour. The matter is already covered by the Administrative Rules.

**Refereeing Commission:** only o.26.1 in favour

o.26.2 not in favour

**Veterans Council:** In favour.

**Women and Fencing Council:** Agreed as amended:

#### o.26

- 1 Refereeing at Veteran World Championships is carried out by referees appointed by the Executive Committee of the FIE, selected by the Refereeing Commission on indication of the Organizing Committee and Veterans Council. **Either, there must be a minimum representation of at least 30% of each gender across all such appointments or the Refereeing Commission must provide a written explanation to the Executive Committee of the FIE.**

Referees must attend the refereeing meeting that takes place the day before the World Championships.

- 2 For **Senior World Cup, Grands Prix and World Cup team competitions**, 8 referees, proposed by the Refereeing Commission, will be designated by the Executive Committee and delegations will not have to provide any referees. **Either there must be a minimum of one person from each gender, if possible. If this is not possible or the Refereeing Commission must provide a written explanation must be provided to the Executive Committee of the FIE.**

The additional referees required (not less than 5) will be provided by the organising committee. **All the referees will be at the expense of the organisers who in return will keep the entry fees.** **Either there must be a minimum of one person from each gender, if possible. Or if this is not possible or a written explanation must be provided to the FIE in the FIE Supervisor's report.**

#### **Opinion of the Executive Committee:**

**o.26.1:** This proposal is duplicating article 9.2.3 of the FIE Administrative Rules. Article 9.2.3 also takes into account weapons, continental representation and other criteria which are not considered in this proposal. Therefore, the Executive Committee is **not in favour** of the proposal.

**o.26.2:** This is impossible to implement in each competition as the criteria of availability of referees, weapons and continental representation must also be taken into account. Therefore, the Executive Committee is **not in favour** of the proposal.

---

**Article:** o.16, o.18, o.26, o.29, o.39, o.50, o.63, o.75, o.103, o.104

P. 7

**Proposal from:** Rules Commission

**Motivation:** Creation of new Veterans chapters.

**o.16**

~~3—Veterans World Championships~~

~~The Directoire Technique is composed of four members of different nationalities, one of whom must represent the country where the competition is held.~~

**o.18**

~~4—Veterans World Championships~~

~~Two Refereeing delegates, one SEMI delegate and two Medical delegates are appointed by the FIE Executive Committee following the recommendations of the respective commissions.~~

**o.26**

- ~~1. Refereeing at Veteran World Championships is carried out by referees appointed by the Executive Committee of the FIE, selected by the Refereeing Commission on indication of the Organizing Committee and Veterans Council.  
Referees must attend the refereeing meeting that takes place the day before the World Championships~~

~~2~~

~~For **Senior World Cup, Grands Prix and World Cup team competitions**, 8 referees, proposed by the Refereeing Commission, will be designated by the Executive Committee and delegations will not have to provide any referees. The additional referees required (not less than 5) will be provided by the organising committee. **All the referees will be at the expense of the organisers who in return will keep the entry fees.**~~

---

**o.29**

~~6)The age groups in veteran competitions are:~~

- ~~a)Age group 50-59: Must be at least 50 years old and less than 60 years old in the year of the competition.  
b)Age group 60-69: Must be at least 60 years old and less than 70 years old in the year of the competition.  
c)Age group 70+: Must be at least 70 years old in the year of the competition.~~

---

~~6—The age groups in veteran competitions are:~~

a) Age group 40-49: Must be at least 40 years old and less than 50 years old in the year of the competition.

b) Age group 50-59: Must be at least 50 years old and less than 60 years old in the year of the competition.

c) Age group 60-69: Must be at least 60 years old and less than 70 years old in the year of the competition.

d) Age group 70+: Must be at least 70 years old in the year of the competition.

**Application :** during the test at the 2025 World Championships (not applicable in 2023 and 2024).

---

## VETERAN WORLD CHAMPIONSHIPS

### **o.39**

1—The programme of the Veteran World Fencing Championships comprises twenty-four events, eighteen individual—three categories for each weapon—and six team—male foil, female foil, male epee, female epee, male sabre and female sabre. The programme must be arranged in such a way as to allow any fencer to participate in all weapons. Team events must be held on the day following the last championship of the three categories of each weapon.

2—No changes of dates are allowed for any competition, after the release of the programme.

3—Each competition must be held in one single day, avoiding long periods of inactivity.

---

### **o.39**

1—The programme of the Veteran World Fencing Championships comprises thirty-six events, twenty-four individual—four categories for each weapon—and twelve team—male foil, female foil, male epee, female epee, male sabre and female sabre (two categories for each weapon and gender). The programme must be arranged in such a way as to allow any fencer to participate in all weapons. Team events must be held on the day following the last championship of the corresponding two individual categories of each weapon.

2—No changes of dates are allowed for any competition, after the release of the programme.

3—Each competition must be held in one single day, except for team events for which the round of pools may be achieved the day before direct elimination avoiding long periods of inactivity.

**Application:** during the test at the 2025 World Championships (not applicable in 2023 and 2024).

---

## **Veterans**

### **o.50**

~~1—Any proposed candidature for organising the Veteran World Championships must be studied at the venue concerned by an ad hoc delegation designated by the Executive Committee, at the invitation of the candidate federation.~~

~~2—The organising committee, who will receive all the entry fees from the participating delegations, must, at their own expense, invite the following international officials (tourist-class return air fare, accommodation and daily allowances):~~

~~a) —The President of the FIE or his representative, who presides over the World Championships and, in particular, controls the smooth running of the Directoire Technique.~~

~~b) —Four members of the Directoire Technique appointed by the Executive Committee of the FIE, one of whom must belong to the organising country.~~

~~c) —One member of the SEMI Committee, appointed by the Executive Committee of the FIE.~~

~~d) —One member of the Refereeing Committee, appointed by the Executive Committee of the FIE.~~

~~e) —Two members of the Medical Committee, appointed by the Executive Committee of the FIE.~~

~~f) —The referees appointed by the Executive Committee of the FIE.~~

~~The officials a) to e) should preferably be selected from the Zone in which the Championships are being held.~~

### ***Entries to competitions***

### **o.63**

~~1—Entries must be sent to the organisers by the competitors' national federation. Entries must be sent not later than one month before the beginning of the championships.~~

~~2—However, up to two days before the competition at noon (local time), fencers may be added by their national federation after payment to the Organizing Committee of a penalty equal to 100 % of the registration fee.~~

~~3—Entries for team championships must be forwarded to the Directoire Technique not later than 4.00 pm (local time) of the day before the competition.~~

~~4—At the Veterans World Championships, entries for the individual events are limited to four fencers in each category per gender, per weapon and per nation. The names must be the same as those on the FIE licences.~~

### **Composition of the pools for Veteran individual championships**

### **o.75**

~~The pools are composed taking into account the following orders of strength:~~

- ~~1. The fencers ranked from the addition of the results in the previous two years Championships, irrespective of age category changes. Scores are awarded according to the following table:~~

<u>1st place 80 points</u>	<u>31th place 7 points</u>	<u>61th place 3,2 points</u>
<u>2nd place 65 points</u>	<u>32th place 6,5 points</u>	<u>62th place 3,1 points</u>
<u>3rd place ex aequo 50 points</u>	<u>33th place 6 points</u>	<u>63th place 3 points</u>
<u>5th place 38 points</u>	<u>34th place 5,9 points</u>	<u>64th place 2,9 points</u>
<u>6th place 36 points</u>	<u>35th place 5,8 points</u>	<u>65th place 2,8 points</u>
<u>7th place 34 points</u>	<u>36th place 5,7 points</u>	<u>66th place 2,7 points</u>
<u>8th place 32 points</u>	<u>37th place 5,6 points</u>	<u>67th place 2,6 points</u>
<u>9th place 30 points</u>	<u>38th place 5,5 points</u>	<u>68th place 2,5 points</u>
<u>10th place 28 points</u>	<u>39th place 5,4 points</u>	<u>69th place 2,4 points</u>
<u>11th place 26 points</u>	<u>40th place 5,3 points</u>	<u>70th place 2,3 points</u>
<u>12th place 24 points</u>	<u>41th place 5,2 points</u>	<u>71th place 2,2 points</u>
<u>13th place 22 points</u>	<u>42th place 5,1 points</u>	<u>72th place 2,1 points</u>
<u>14th place 20 points</u>	<u>43th place 5 points</u>	<u>73th place 2 points</u>
<u>15th place 18 points</u>	<u>44th place 4,9 points</u>	<u>74th place 1,9 points</u>
<u>16th place 16 points</u>	<u>45th place 4,8 points</u>	<u>75th place 1,8 points</u>
<u>17th place 14 points</u>	<u>46th place 4,7 points</u>	<u>76th place 1,7 points</u>
<u>18th place 13,5 points</u>	<u>47th place 4,6 points</u>	<u>77th place 1,6 points</u>
<u>19th place 13 points</u>	<u>48th place 4,5 points</u>	<u>78th place 1,5 points</u>
<u>20th place 12,5 points</u>	<u>49th place 4,4 points</u>	<u>79th place 1,4 points</u>
<u>21th place 12 points</u>	<u>50th place 4,3 points</u>	<u>80th place 1,3 points</u>
<u>22th place 11,5 points</u>	<u>51th place 4,2 points</u>	<u>81th place 1,2 points</u>
<u>23th place 11 points</u>	<u>52th place 4,1 points</u>	<u>82th place 1,1 points</u>
<u>24th place 10,5 points</u>	<u>53th place 4 points</u>	<u>83th place 1 points</u>
<u>25th place 10 points</u>	<u>54th place 3,9 points</u>	<u>84th place 0,9 points</u>
<u>26th place 9,5 points</u>	<u>55th place 3,8 points</u>	<u>85th place 0,8 points</u>
<u>27th place 9 points</u>	<u>56th place 3,7 points</u>	<u>86th place 0,7 points</u>
<u>28th place 8,5 points</u>	<u>57th place 3,6 points</u>	<u>87th place 0,6 points</u>
<u>29th place 8 points</u>	<u>58th place 3,5 points</u>	<u>88th place 0,5 points</u>
<u>30th place 7,5 points</u>	<u>59th place 3,4 points</u>	<u>89th place 0,4 points</u>
	<u>60th place 3,3 points</u>	<u>90th place 0,3 points</u>
		<u>91th place 0,2 points</u>
		<u>92th place 0,1 points</u>
		<u>93th place and after 0 points</u>

**2**— All other fencers in order of age, starting from the youngest.

**3**— The allocation of fencers in the pools must be made in such a way as to place fencers of the same nationality, as far as possible, in different pools, by moving them down the ranking as necessary.

**4**— If in any category there are fewer than ten competitors, the competition is held as a poule unique followed by direct elimination.

**5**— If in any category there are fewer than 6 competitors, they will fence with the next lower age category. A separate ranking for that category will be extrapolated from the combined categories' final rankings at the end of the competition.

~~6—If in any category there is only one competitor, the event in that category is cancelled.~~

~~7—No fencer is eliminated after the pools, all are entered into the direct elimination.~~

## **C. VETERANS**

### ***Team championships***

#### **o.103**

##### ~~1—Participation~~

~~Each country may enter one team per gender and per weapon, thus giving a total of 6 competitions.~~

~~The teams shall be composed of fencers who participated in the individual competition of the corresponding weapon, but c.f. o.103.2 b below.~~

##### ~~2—The rules for team competitions are applicable with the following exceptions:~~

~~a) For each weapon, the teams are composed of three fencers of the same nationality, one from category "A", one from "B" and one from "C", with or without a reserve for each category. A team cannot begin the match if it is not complete.~~

~~b) In the case of a team being short of a fencer in any of the weapons, the team may use a fencer who has competed in the individual championships at another weapon or who is registered but has yet to compete, but his/her ranking will be deemed to be last in the individual competition at the weapon of the team in which he is going to fence plus 1.~~

~~c) The teams are placed in the pools according to the ranking of the three fencers in the individual championship, the team having the lowest total being ranked highest. All the fencers registered for the team event must be present at the piste before the start of the match.~~

~~d) Each team may request, before a given bout, the substitution of a fencer. However, in case of injury or other medical reason duly recognized by the Medical delegate, the substitution can be immediate, even during the relay.~~

~~There can only be one substitution per team per match.~~

~~3—A fencer who has been replaced because of an injury may not fence again during that match. If both a fencer and the reserve, if any, are forced to retire, or if a fencer is excluded, their team is deemed to have lost the match.~~

~~4—The relay system is always applied. The three fencers of a team fence against their opponent of the same category. Each fencer fences his/her opponent twice giving a total of 6 bouts. The bouts are for 5 hits (5-10-15-20 etc.). Exceptionally, a relay may end at more than 5,10,15 etc. if a fencer scores a valid last hit of the relay and is at the same time awarded an additional penalty hit: in this case both hits will be counted; the maximum time for each bout is 3 minutes.~~

~~5—The team that first reaches the maximum score of 30 hits, or that which has scored the greatest number of hits after the expiry of regulation time, is the winner.~~

~~6—The order of categories for each match is established by the referee with the captains on the piste prior to the start of the match: The referee will draw lots and the winning captain will choose the first category in the order. The losing captain will choose the second category.~~

~~7—The competition consists of a round of pools of 3 or 4 teams, in which all the teams participate, and a direct elimination phase for the highest placed 16 teams; the other teams will be classified according to their ranking after the round of pools.~~

~~a) —The order of fights in a pool of 4 is as follows:~~

~~b) —Match 1 : The team ranked 1 vs the team ranked 4~~

~~—Match 2 : The team ranked 2 vs the team ranked 3 Match 3 : The winner of Match 1 vs the loser of Match 2~~

~~—Match 4 : The winner of Match 2 vs the loser of Match 1~~

~~—Match 5 and Match 6 : The two remaining matches.~~

~~b) —The order of fights in a pool of 3 is as follows:~~

~~—Match 1 : The team ranked 2 vs the team ranked 3~~

~~—Match 2 : The team ranked 1 vs the loser of Match 1~~

~~—Match 3 : The team ranked 1 vs the winner of Match 1~~

~~The initial ranking on which the drawing of the pools is based is established from the results of the fencers in the individual events. (cf. o.103.2.c)~~

~~Using the results of the pools, an overall ranking is established, from which the top 16 (or 8 if there are fewer than 16 teams taking part) are promoted to a direct elimination tableau, in which the teams are placed according to this ranking. Should there be absolute equality in results between teams ranked 16 and 17 (or 8 and 9), the team ranked higher before the round of pools will be qualified.~~

~~However, teams which have already fenced each other in the pools should not meet again immediately in the direct elimination. To avoid this, the lower ranked of the two teams in question may be moved:~~

~~—in the case of a tableau of 16, the team ranked 9 may change places only with the team ranked 10, the team ranked 11 may change places only with the team ranked 12, the team ranked 13 may change places only with the team ranked 14 and the team ranked 15 may change places only with the team ranked 16.~~

~~—in the case of a tableau of 8, the team ranked 5 may change places only with the team ranked 6 and the team ranked 7 may change places only with the team ranked 8.~~

~~8—If there are fewer than 6 teams, they all fence in a poule unique; a match for the 3rd and 4th places is then held, followed by a match for the first place between the teams who came 1st and 2<sup>nd</sup> in the pool.~~

~~9—The places in the final ranking table from 5th onwards are not fought for and teams are classified, within each round of the table, according to their ranking after the poules.~~

---

## **o.103**

### **4—Participation**

~~Each country may enter one team per category (Veterans and Grand Veterans) per gender and per weapon, thus giving a total of twelve competitions.~~

~~The teams shall be composed of fencers who participated in the individual competition of the corresponding weapon, but c.f. o.103.2 b below.~~

~~2—The rules for team competitions are applicable with the following exceptions:~~

~~**Veterans:** teams of three composed of fencers belonging to either age group 40-49 or to age group 50-59, with at least one fencer belonging to age group 50-59, plus up to two reserves.~~

~~**Grand Veterans:** teams of three composed of fencers belonging to either age group 60-69 or to age group 70 and over, with at least one fencer belonging to age group 70 and over, plus up to two reserves.~~

~~Fencing mode is 45 hits relay described in o.99 with application of passivity rule at any bout.~~

~~The competition begins with a round of pools of 3 and 4 teams established according to o.103 c) and followed by a direct elimination phase according to o.103 7.~~

~~Particular cases depending on the number of teams:~~

~~• only 1 team: the organisers must inform all nations that there will be no competition at that weapon.~~

~~• 2 teams: only one match between these two teams.~~

~~• 3 teams: one poule of three followed by D.E. from an incomplete tableau of 4.~~

~~• 4 teams: one poule of four followed by D.E. from a tableau of 4.~~

~~• 5 teams: one poule of five followed by D.E. from an incomplete tableau of 8.~~

~~The losers of the semi-finals have to fence for the Bronze medal.~~

~~a) — In the case of a team being short of a fencer in any of the weapons, the team may use a fencer who has competed in the individual championships at another weapon or who is registered but has yet to compete, but his/her ranking will be deemed to be last in the individual competition at the weapon of the team in which he is going to fence plus 1.~~

~~b) — The teams are placed in the pools according to the ranking of the three fencers in the individual championship, the team having the lowest total being ranked highest. All the fencers registered for the team event must be present at the piste before the start of the match.~~

~~c) — Each team may request, before a given bout, the substitution of a fencer. However, in case of injury or other medical reason, duly recognized by the medical delegate, the substitution can be immediate, even during the relay.~~

~~There can be up to two substitutions of reserves per match but must maintain compliance with the age category representation requirement.~~

~~3—A fencer who has been replaced because of an injury or other medical reason may not fence again during that match. If both a fencer and the reserve, if any, are forced to retire, or if a fencer is excluded, their team is deemed to have lost the match.~~



~~4—The competition consists of a round of pools of 3 or 4 teams, in which all the teams participate, and a direct elimination phase for the highest placed 16 teams; the other teams will be classified according to their ranking after the round of pools.~~

~~a) —The order of fights in a pool of 4 is as follows:~~

~~Match 1 : The team ranked 1 vs the team ranked 4~~

~~Match 2 : The team ranked 2 vs the team ranked 3~~

~~Match 3 : The winner of Match 1 vs the loser of Match 2~~

~~Match 4 : The winner of Match 2 vs the loser of Match 1~~

~~Match 5 and Match 6 : The two remaining matches.~~

~~b) —The order of fights in a pool of 3 is as follows:~~

~~Match 1 : The team ranked 2 vs the team ranked 3~~

~~Match 2 : The team ranked 1 vs the loser of Match 1~~

~~Match 3 : The team ranked 1 vs the winner of Match 1~~

~~The initial ranking on which the drawing of the pools is based is established from the results of the fencers in the individual events. (cf. o.103.2.c)~~

~~Using the results of the pools, an overall ranking is established, from which the top 16 (or 8 if there are fewer than 16 teams taking part) are promoted to a direct elimination tableau, in which the teams are placed according to this ranking. Should there be absolute equality in results between teams ranked 16 and 17 (or 8 and 9), the team ranked higher before the round of pools will be qualified.~~

~~However, teams which have already fenced each other in the pools should not meet again immediately in the direct elimination. To avoid this, the lower ranked of the two teams in question may be moved:~~

~~– in the case of a tableau of 16, the team ranked 9 may change places only with the team ranked 10, the team ranked 11 may change places only with the team ranked 12, the team ranked 13 may change places only with the team ranked 14 and the team ranked 15 may change places only with the team ranked 16.~~

~~– in the case of a tableau of 8, the team ranked 5 may change places only with the team ranked 6 and the team ranked 7 may change places only with the team ranked 8.~~

~~5—If there are fewer than 6 teams, they all fence in a poule unique; a match for the 3rd and 4th places is then held, followed by a match for the first place between the teams who came 1st and 2<sup>nd</sup> in the pool.~~

~~6—The places in the final ranking table from 5th onwards are not fought for and teams are classified, within each round of the table, according to their ranking after the poules.~~

**Application :** during the test at the 2025 World Championships (not applicable in 2023 and 2024)

---

## **D.C. OLYMPIC GAMES**

### **o.104**

The organisation formulae for the Olympic Games are established by the Executive Committee, with the approval of the IOC. (See art. 9.1.1.1 of the Administrative rules).

---

## **PART E - VETERANS**

### **BODIES RESPONSIBLE FOR ORGANISATION AND CONTROL**

#### ***Organising Committee Veterans***

**o.111**

The Directoire Technique is composed of people who have the experience and competence to organise competitions.

The Directoire Technique is composed of four members of different nationalities, one of whom must represent the country where the competition is held **and, if possible, a representative of the country where the competition will be held the following year.**

#### ***Appointment of refereeing, SEMI and medical delegates***

**o.112**

Refereeing delegates must be members of the FIE Refereeing Commission.

SEMI delegates must be members of the FIE SEMI Commission.

Medical delegates must be members of the FIE Medical Commission.

#### ***Veterans World Championships***

Two Refereeing delegates, one SEMI delegate and two Medical delegates are appointed by the FIE Executive Committee following the recommendations of the respective commissions.

#### ***Refereeing***

**o.113**

Refereeing at Veteran World Championships is carried out by referees appointed by the Executive Committee of the FIE, selected by the Refereeing Commission on indication of the Organizing Committee and Veterans Council.

Referees must attend the refereeing meeting that takes place the day before the World Championships.

#### ***AGE OF PARTICIPANTS***

**o.114**

The age groups in veteran competitions are:

a) Age group 50-59: Must be at least 50 years old and less than 60 years old in the year of the competition.

b) Age group 60-69: Must be at least 60 years old and less than 70 years old in the year of the competition.

c) Age group 70+: Must be at least 70 years old in the year of the competition.

---

The age groups in veteran competitions are:

- a) Age group 40-49: Must be at least 40 years old and less than 50 years old in the year of the competition.
- b) Age group 50-59: Must be at least 50 years old and less than 60 years old in the year of the competition.
- c) Age group 60-69: Must be at least 60 years old and less than 70 years old in the year of the competition.
- d) Age group 70+: Must be at least 70 years old in the year of the competition.

Application : during the test at the 2025 World Championships (not applicable in 2023 and 2024)

---

### *Pre-competition procedures*

#### **PROGRAMMING**

#### **VETERANS WORLD CHAMPIONSHIPS**

##### **o.115**

- 1 The programme of the Veteran World Fencing Championships comprises twenty-four events, eighteen individual – three categories for each weapon - and six team — male foil, female foil, male epee, female epee, male sabre and female sabre. The programme must be arranged in such a way as to allow any fencer to participate in all weapons. Team events must be held on the day following the last championship of the three categories of each weapon.
  - 2 No changes of dates are allowed for any competition, after the release of the programme.
  - 3 Each competition must be held in one single day, avoiding long periods of inactivity.
- 

- 1 The programme of the Veteran World Fencing Championships comprises thirty-six events, twenty-four individual – four categories for each weapon - and twelve team — male foil, female foil, male epee, female epee, male sabre and female sabre (two categories for each weapon and gender). The programme must be arranged in such a way as to allow any fencer to participate in all weapons. Team events must be held on the day following the last championship of the corresponding two individual categories of each weapon.
- 2 No changes of dates are allowed for any competition, after the release of the programme.
- 3 Each competition must be held in one single day, except for team events for which the round of pools may be achieved the day before direct elimination avoiding long periods of inactivity.

Application: during the test at the 2025 World Championships (not applicable in 2023 and 2024)

---

## INVITATIONS

### *Invitation to international officials*

#### **Veterans**

##### **o.116**

- 1 Any proposed candidature for organising the Veteran World Championships must be studied at the venue concerned by an ad hoc delegation designated by the Executive Committee, at the invitation of the candidate federation.
- 2 The organising committee, who will receive all the entry fees from the participating delegations, must, at their own expense, invite the following international officials (tourist-class return air fare, accommodation and daily allowances):
  - a) The President of the FIE or his representative, who presides over the World Championships and, in particular, controls the smooth running of the Directoire Technique.
  - b) Four members of the Directoire Technique appointed by the Executive Committee of the FIE, one of whom must belong to the organising country.
  - c) One member of the SEMI-~~Committee~~-Commission, appointed by the Executive Committee of the FIE.
  - d) ~~One~~ **Two** members of the Refereeing ~~Committee~~-Commission, appointed by the Executive Committee of the FIE.
  - e) Two members of the Medical ~~Committee~~-Commission, appointed by the Executive Committee of the FIE.
  - f) The referees appointed by the Executive Committee of the FIE.

The officials a) to e) should preferably be selected from the Zone in which the Championships are being held.

## ENTRIES

### *Veterans World Championships*

#### *Entries for competitions*

##### **o.117**

- 1 **The entry of the names** of the fencers and all possible replacements, and the entry of teams, must be made via the FIE website 7 days before the competition at the latest (midnight Lausanne time).  
For team entries, the names of the fencers making up the teams may be changed, by informing the organizers, up to the day before the competition, not later than 4.00 pm (local time). However, a replacement can be made after this stage, and at the latest at the end of the individual event, in the case of injury or other medical reason duly certified by the competition medical doctor.
- 2 **Withdrawal of a fencer or team.**  
  
After the closing deadline for entries, no named fencer or team may be withdrawn except for injury or other medical reason or force majeure: the national federation must inform the FIE and the organizers.
- 3 **Substitution of a fencer.**

Until the Wednesday preceding the competition (midnight, Lausanne time), a fencer may be replaced by another. To do this, the national federation must send to the FIE, by fax or e-mail, a written request to substitute the fencer.

**4 Addition of a fencer or a team after the dead-line.**

From the Wednesday preceding the competition until 12 noon (local time) on the day preceding the competition, one or more fencers and/or a team may be added by national federations after payment to the FIE of a penalty according to the scale in force (cf o.31, table of financial penalties and fines).

**5** Should a fencer or team who have been entered not present themselves to fence, a fine (cf o.31, table of financial penalties and fines), payable to the FIE, will be imposed to the federation of the faulty fencer or team, except in cases of properly authenticated 'force majeure'.

**6** The organisers of all official competitions must, at risk of a penalty of a fine payable to the FIE (cf o.31, table of financial penalties and fines), refuse any entry of either fencer or referee not in possession of an FIE license valid for the current season.

## **PROCEDURES DURING COMPETITIONS**

### **Composition of the pools for the individual Veterans championships**

**o.118**

The pools are composed taking into account the following orders of strength:

- 1 The fencers ranked from the addition of the results in the previous two **years** Veterans World Championships, irrespective of age category changes.

Scores are awarded according to the following table:

1st place 80 points	31th place 7 points	61th place 3,2 points
2nd place 65 points	32th place 6,5 points	62th place 3,1 points
3rd place <i>ex aequo</i> 50 points	33th place 6 points	63th place 3 points
5th place 38 points	34th place 5,9 points	64th place 2,9 points
6th place 36 points	35th place 5,8 points	65th place 2,8 points
7th place 34 points	36th place 5,7 points	66th place 2,7 points
8th place 32 points	37th place 5,6 points	67th place 2,6 points
9th place 30 points	38th place 5,5 points	68th place 2,5 points
10th place 28 points	39th place 5,4 points	69th place 2,4 points
11th place 26 points	40th place 5,3 points	70th place 2,3 points
12th place 24 points	41th place 5,2 points	71th place 2,2 points
13th place 22 points	42th place 5,1 points	72th place 2,1 points
14th place 20 points	43th place 5 points	73th place 2 points
15th place 18 points	44th place 4,9 points	74th place 1,9 points
16th place 16 points	45th place 4,8 points	75th place 1,8 points

17th place 14 points	46th place 4,7 points	76th place 1,7 points
18th place 13,5 points	47th place 4,6 points	77th place 1,6 points
19th place 13 points	48th place 4,5 points	78th place 1,5 points
20th place 12,5 points	49th place 4,4 points	79th place 1,4 points
21th place 12 points	50th place 4,3 points	80th place 1,3 points
22th place 11,5 points	51th place 4,2 points	81th place 1,2 points
23th place 11 points	52th place 4,1 points	82th place 1,1 points
24th place 10,5 points	53th place 4 points	83th place 1 points
25th place 10 points	54th place 3,9 points	84th place 0,9 points
26th place 9,5 points	55th place 3,8 points	85th place 0,8 points
27th place 9 points	56th place 3,7 points	86th place 0,7 points
28th place 8,5 points	57th place 3,6 points	87th place 0,6 points
29th place 8 points	58th place 3,5 points	88th place 0,5 points
30th place 7,5 points	59th place 3,4 points	89th place 0,4 points
	60th place 3,3 points	90th place 0,3 points
		91th place 0,2 points
		92th place 0,1 points
		93th place and after 0 points

- 2 All other fencers in order of age, starting from the youngest.
- 3 The allocation of fencers in the pools must be made in such a way as to place fencers of the same nationality in different pools, as far as possible (staggering).
- 4 If in any category there are fewer than ten competitors, the competition is held as a poule unique followed by direct elimination.
- 5 If in any category there are fewer than 6 competitors, they will fence with the next lower age category. A separate ranking for that category will be extrapolated from the combined categories' final rankings at the end of the competition.
- 6 If in any category there is only one competitor, the event in that category is cancelled.
- 7 No fencer is eliminated after the pools. All the fencers participate in the direct elimination phase.

## **VETERANS TEAM EVENTS**

### **o.119**

#### **1 Participation**

Each country may enter one team per gender and per weapon, thus giving a total of 6 competitions.

The teams shall be composed of fencers who participated in the individual competition of the corresponding weapon, but c.f. o.103.2 b below.

- 2** The rules for team competitions are applicable with the following exceptions:
  - a)** For each weapon, the teams are composed of three fencers of the same nationality, one from category "A", one from "B" and one from "C", with or without a reserve for each category. A team cannot begin the match if it is not complete.
  - b)** In the case of a team being short of a fencer in any of the weapons, the team may use a fencer who has competed in the individual championships at another weapon or who is registered but has yet to compete, but his/her ranking will be deemed to be last in the individual competition at the weapon of the team in which he is going to fence plus 1.
  - c)** The teams are placed in the pools according to the ranking of the three fencers in the individual championship. The team ranked 1 is the one having the lowest total. All the fencers registered for the team event must be present at the piste before the start of each match.
  - d)** Each team may request, before a given relay, the substitution of a fencer. However, in case of injury or other medical reason duly recognized by the Medical delegate, the substitution can be immediate, even during the relay.

There can only be one substitution per team per match.

- 3** A fencer who has been replaced because of an injury may not fence again during that match. If both a fencer and the reserve are forced to retire, or if a fencer is excluded, their team is deemed to have lost the match.
- 4** The relay system is always applied. The three fencers of a team fence against their opponent of the same category. Each fencer fences his/her opponent twice giving a total of 6 relays. The relays are for 5 hits (5-10-15-20- etc.). Exceptionally, a relay may end at more than 5,10,15 etc. if a fencer scores a valid last hit of the relay and is at the same time awarded an additional penalty hit: in this case both hits will be counted; the maximum time for each relays is 3 minutes.
- 5** The team that first reaches the maximum score of 30 hits, or that which has scored the greatest number of hits after the expiry of regulation time, is the winner.
- 6** The order of categories for each match is established by the referee with the captains on the piste prior to the start of the match: The referee will draw lots and the winning captain will choose the first category in the order. The losing captain will choose the second category.
- 7** The competition consists of a round of pools of 3 or 4 teams, in which all the teams participate, and a direct elimination phase for the highest placed 16 teams; the other teams will be classified according to their ranking after the round of pools.
  - a)** The order of matches in a pool of 4 is as follows:
    - Match 1 : The team ranked 1 vs the team ranked 4
    - Match 2 : The team ranked 2 vs the team ranked 3
    - Match 3 : The winner of Match 1 vs the loser of Match 2
    - Match 4 : The winner of Match 2 vs the loser of Match 1
    - Match 5 and Match 6 : The two remaining matches.
  - b)** The order of matches in a pool of 3 is as follows:
    - Match 1 : The team ranked 2 vs the team ranked 3

Match 2 : The team ranked 1 vs the loser of Match 1  
Match 3 : The team ranked 1 vs the winner of Match 1

The initial ranking on which the drawing of the pools is based is established from the results of the fencers in the individual events. (cf. o.103.2.c)

The composition of the direct elimination table of 16 teams (or 8 if there are less than 16 teams) is established according to the general ranking established by the results of all the teams in the pool round. In the event of an absolute tie between the teams ranked 16 and 17 (or 8 and 9), the highest ranked team in the initial pool ranking shall qualify.

However, in no case, teams which have already fenced each other in the pools should meet again immediately in the direct elimination. To avoid this, the lower ranked of the two teams in question may be moved:

- in the case of a tableau of 16, the team ranked 9 may change places only with the team ranked 10, the team ranked 11 may change places only with the team ranked 12, the team ranked 13 may change places only with the team ranked 14 and the team ranked 15 may change places only with the team ranked 16.
  - in the case of a tableau of 8, the team ranked 5 may change places only with the team ranked 6 and the team ranked 7 may change places only with the team ranked 8.
- 8** If fewer than 6 teams participate in the competition, they all fence in a poule unique; a match for the 3rd and 4th places is then held, followed by a match for the first place between the teams who came 1st and 2nd in the pool.
- 9** Ranking matches from 5th place onwards will not be fenced and teams will be ranked, in each round of the table, according to their ranking after the pools.
- 

## 1 Participation

Each country may enter one team per category (Veterans and Grand Veterans) per gender and per weapon, thus giving a total of twelve competitions.

The teams shall be composed of fencers who participated in the individual competition of the corresponding weapon, but c.f. o.103.2 b below.

## 2 The rules for team competitions are applicable with the following exceptions:

**Veterans:** teams of three composed of fencers belonging to either age group 40-49 or to age group 50-59, with at least one fencer belonging to age group 50-59, plus up to two reserves.

**Grand Veterans:** teams of three composed of fencers belonging to either age group 60-69 or to age group 70 and over, with at least one fencer belonging to age group 70 and over, plus up to two reserves.

Fencing mode is 45 hits relay described in o.99 with application of non-combativity rule at any match.

The competition begins with a round of pools of 3 and 4 teams -established according to o.103 c) - and followed by a direct elimination phase according to o.103 7.

Particular cases depending on the number of teams:

- only 1 team: the organisers must inform all nations that there will be no competition at that weapon.



- 2 teams: only one match between these two teams.
- 3 teams: one poule of three followed by D.E. from an incomplete tableau of 4.
- 4 teams: one poule of four followed by D.E. from a tableau of 4.
- 5 teams: one poule of five followed by D.E. from an incomplete tableau of 8.

The losers of the semi-finals have to fence for the Bronze medal.

- In the case of a team being short of a fencer in any of the weapons, the team may use a fencer who has competed in the individual championships at another weapon or who is registered but has yet to compete, but his/her ranking will be deemed to be last in the individual competition at the weapon of the team in which he is going to fence plus 1.
- The teams are placed in the pools according to the ranking of the three fencers in the individual championship. The number 1 team is the one with the least points. All the fencers registered for the team event must be present at the piste before the start of each match.
- Each team may request, before a given relay, the substitution of a fencer. However, in case of injury or other medical reason, duly recognized by the medical delegate, the substitution can be immediate, even during the relay.

There can be up to two substitutions of reserves per match but must maintain compliance with the age category representation requirement.

**Application :** during the test at the 2025 World Championships (not applicable in 2023 and 2024).

**Medical commission:** vote 10/10 support of the proposal.

**SEMI Commission: In favour.** In view of the increase in size of the Veteran World Championships it is essential that a minimum of 2 SEMI Delegate should be appointed for efficient running of the competition.

**Veterans Council: In favour.**

**Rules Commission: In favour.**

**Refereeing Commission:**

- **In favour** with creation of new chapter for Veterans World Championship
- Modification of o.112 in proposal to reduce unnecessary repetitions as below

o.112

Two Refereeing delegates, one SEMI delegate and two Medical delegates must be the members of the FIE Commissions and be appointed by the FIE Executive Committee following the recommendations of the respective commissions.

**Opinion of the Executive Committee:** In favour of the proposal with the modification from the Refereeing Commission.

---

**Article:** o.29 and o.30

**Proposal from:** Rules Commission

**Motivation:** Rewrite the rule for a better understanding of its application.

**o.29**

- 3 Fencers taking part in all the official FIE Junior competitions, individual or team, must be under 20 years old at midnight on 31st December of the year preceding the year in which the competition takes place ~~(cf o.30)~~.

To be eligible to compete in the current season's official events, including the current season's World Junior Championships, fencers must be under 20 years of age at midnight on 31 December of the current season.

**o.30**

~~Only fencers who are of an age to qualify for the next Junior World Championships may fence in the official FIE Junior competitions, individual or team, of the current fencing season.~~

**Rules Commission:** In favour.

**Opinion of the Executive Committee:** In favour of the proposal.

---

**Article:** o.42 and o.102

**Proposal from:** Rules Commission

**Motivation:** To add the team event formula to the zone championship which is an organisational rule in the administrative regulations.

**o.42**

- 4 The formulae of the competitions are specified in the **administrative** rules ~~(see art. 9.4.3)~~ and in the following articles: o.100, o.101 and o.102 (o.102.1 first sentence and o.102.2).

**o.102**

- 1 The **first four teams** are placed in the direct elimination table according to the current official team ranking of the FIE (cf. o.109); the remaining ranked teams will be placed in the table by drawing of lots in pairs.

The **teams that are not classified** will occupy the last places in the table and will be separated by drawing of lots.

- 3 At the Zonal Championships, teams without FIE ranking will occupy the last places in the table. They will be separated according to the final ranking obtained in the individual competition by the three best fencers in the team. The fencers of the teams who do not have a ranking in the individual competition will take the last place +1.

**Rules Commission:** In favour.

**Opinion of the Executive Committee:** In favour of the proposal. If it is accepted by the Congress, then the second part of article 9.4.3. b) will be removed from the FIE Administrative Rules in order to avoid duplication of texts.

---

**Article:** o.50

P. 10

**Proposal from:** Veterans Council

**Motivation:** We think it would be appropriate that a representative of the Veterans' Council to be a part of the official guests at the Veterans World Championships. His role would be to listen to the fencers, the heads of delegation and the organizers in order to collect all their remarks and suggestions, which would be gathered in a report that would allow the members of the Council to study and propose the improvements that would seem relevant.

**o.50**

(...)

2 The organising committee **of the World Championships**, who will receive all the entry fees from the participating delegations, must, at their own expense, invite the following international officials (tourist-class return air fare, accommodation and daily allowances):

a) The President of the FIE or his representative, who presides over the World Championships and, in particular, controls the smooth running of the Directoire Technique.

b) **A representative of the Veterans Council.**

~~b)~~ c) Four members of the Directoire Technique appointed by the Executive Committee of the FIE, one of whom must belong to the organising country.

~~e)~~ d) One member of the SEMI ~~Committee~~ **Commission**, appointed by the Executive Committee of the FIE.

d) e) One member of the Refereeing **Committee Commission**, appointed by the Executive Committee of the FIE.

e) f) Two members of the Medical **Committee Commission**, appointed by the Executive Committee of the FIE.

e) g) The referees designated by the Executive Committee of the FIE

**Veterans Council:** In favour.

**Rules Commission:** Not in favour with the point 2 b). A representative of the Veteran Council, proposed by the Veteran Council, is a member of the the Directoire Technique.

In favour with the other points.

**Opinion of the Executive Committee:** The Directoire Technique of the Veteran World Championships already includes a member of the Veterans Council proposed by the Veterans Council. Therefore, item 2 b) would add a second member of the Veterans Council and increase the costs for the organisers. The Executive Committee is in favour of the proposal but without item 2b).

---

**Article:** o.99

P. 11

**Proposal from:** Rules Commission

**Motivation:** Define the rest time between two matches per team.

**o.99**

10 A 10-minute rest must always be given between two matches of the same team.

**Refereeing Commission:** In favour.

**Rules Commission:** In favour.

**Opinion of the Executive Committee:** In favour of the proposal.

---

**Article:** o.100

P.12

**Proposal from: Rules Commission**

**Motivation:** The team events of the Zone Championships are run according to the rules of the Senior and Junior World Cups

**TEAM EVENTS**

**A. SENIOR AND JUNIOR WORLD CHAMPIONSHIPS, ~~ZONAL CHAMPIONSHIPS~~**

**B. SENIOR AND JUNIOR TEAM WORLD CUPS ~~AND ZONAL CHAMPIONSHIPS~~**

**o.100**

Apart from the following aspects, the competition is run in accordance with rules laid down for the team events in the Junior, ~~and~~ Senior World Championships ~~and Zonal Championships~~ respectively.

**Rules Commission:** In favour.

**Opinion of the Executive Committee:** In favour of the proposal.

---

**Article: o.105**

**P.13**

**Proposal from: Rules Commission**

**Motivation:** the zone championships benefit from a coefficient of 1.5. 4 or 8 pistes must be equipped with video refereeing.

***Video-refereeing***

**o.105**

4. For individual competitions of the Junior and Cadet World Championships, video-refereeing is compulsory as soon as the timetable allows the competition to be run on a maximum of 8 pistes, all equipped for video-refereeing and in any case, from the table of 32.

For team competitions ~~in the conventional weapons~~, video-refereeing is compulsory **from the table of 16**, including ranking matches table 5-8.

~~In epee, video-refereeing is compulsory from the table of 8, including ranking matches table 5-8.~~

Senior zonal championships	T 64	T 16	<del>4</del> or 8	T 1-8
----------------------------	------	------	-------------------	-------

**Rules Commission:** In favour as modified:

**Motivation :** the zone championships benefit from a coefficient of 1.5. 8 pistes must be equipped with video refereeing.

Senior zonal championships	T 64	T 16	4 8	T 1-8
----------------------------	------	------	-----	-------

**Refereeing Commission:** In favour with modification o.105.4 and o.105.5 as below

Senior zonal championships	T 64	T 16	4 or 8	T 1-8
----------------------------	------	------	--------	-------

**SEMI Commissio :** In favour with amendments: ~~deleted 4 or —maximum of~~

- 4 For individual competitions of the Junior and Cadet World Championships, video-refereeing is compulsory as soon as the timetable allows the competition to be run on a ~~maximum of~~ 8 pistes, all equipped for video-refereeing and in any case, from the table of 32.

Senior zonal championships	T 64	T 16	<del>4</del> or 8	T 1-8
----------------------------	------	------	-------------------	-------

**Opinion of the Executive Committee:** In favour of o.105.4 and of “4 or 8 pistes”:

Senior zonal championships	T 64	T 16	4 or 8	T 1-8
----------------------------	------	------	--------	-------

**Article:** o.108

**Proposal from:** Rules Commission

**Motivation:** Add "Juniors" to the scale

**o.108**

## 2 Scale of points

a) The ranking of **Seniors and Juniors** is based on the following **points system**:

1st place	32 points
2nd place	26 points
3rd place <i>ex aequo</i>	20 points
5th–8th places	14 points
9th–16th places	8 points
17th–32nd places	4 points
33rd–64th places	2 points
65th–96th places	1 point
97th-128 <sup>th</sup>	0.5 point
129th-256 <sup>th</sup>	0.25 point

**Rules Commission:** In favour.

**Opinion of the Executive Committee:** In favour of the proposal.

---

**Article:** o.109

P.15

**Proposal from:** Rules Commission

**Motivation:** To complete o.109.1 b). The cancellation of many competitions in the 2020/2021 season has caused problems with the allocation of points.

**o.109**

## 1 Official team ranking of the FIE

b) The official team ranking of the FIE is **rolling and updated on a permanent basis**:

~~the first World Cup team event which is held during the current year cancels out the first World Cup team event held the year before, and so forth for the remainder of the World Cup team events.~~

~~The points obtained at an event replace the points obtained at the corresponding event held the year before. If an event does not take place in the current season, the points obtained at the same event in the previous season are deleted on the anniversary of the event.~~

Team World Cup events are numbered in order of their scheduled dates in the calendar.

The points awarded in Event 1 of the current season replace the points awarded in Event 1 of the previous season and so on.

If an event is cancelled during the current season, the points acquired in the corresponding event of the previous season will be deleted on the date allocated to that event in the current season's calendar.

**Rules Commission:** In favour.

**Opinion of the Executive Committee:** In favour of the proposal.

---

**Article:** o.109

P.16

**Proposal from:** Rules Commission

**Motivation:** Awarding of points to teams placed between 33<sup>rd</sup> and 64<sup>th</sup> .

**o.109**

## 2 Team points scale.

a) The ranking will be based on the following scale of points:

1st place 64 points	10th place	24 points
2nd place 52 points	11th place	23 points
3rd place 40 points	12th place	22 points
4th place 36 points	13th place	21 points
5th place 32 points	14th place	20 points
6th place 30 points	15th place	19 points
7th place 28 points	16th place	18 points
8th place 26 points	17th–32nd	8 points
	33rd to	4 points
9th place 25 points	64th	



**Rules Commission:** In favour.

**Opinion of the Executive Committee:** In favour of the proposal but starting from the season 2024-2025 in order not to impact the Olympic qualification which is currently taking place.

**Article:** Table of contents

P. 17

**Proposal from:** Rules Commission

**Motivation:** -

## TABLE OF CONTENTS

### Part A - General rules for the Competitions

#### Chapter 1. Introduction

Application	o.1-2
Types of competitions	o.3
Criteria for World Cup competitions	o.4

#### Chapter 2. Glossary

o. 5-9

#### Chapter 3. Bodies Responsible for Organization and Control

The Organising Committee	o.10
The Central Office of the FIE	o.11
Supervision by the FIE	o.12
Technical Delegate of the FIE	o.13
The Directoire Technique	o.14-17
Designation of refereeing, SEMI, and medical delegates	o.18
SEMI delegates	o.19
The Refereeing delegates	o.20
The Medical delegates	o.21
The Supervisor	o.22-23
Refereeing	o.24-26
Specialized personnel	o.27
Checking of Equipment	o.28

#### Chapter 4. Age of Participants

o.29-30

#### Chapter 5. Financial penalties and Fines

o.31

### Part B – Procedures before Competitions

#### Chapter 1. Programming

Programme of the competitions	o.32
Timetable	o.33-35
Senior world championships	o.36

Junior and cadet World Championships	o.37-38
<del>Veterans World Championships</del>	<del>e.39</del>
Grand Prix, Senior & Junior World Cups, Satellites	o.40-41
Zonal Championship	o.42
Olympic Games	o.43
Regional Games	o.44-45

## Chapter 2. Invitations

Official Invitation	o.46-47
World Championships Seniors, Juniors, <del>Veterans</del>	o.48-50
Grand Prix, Senior & Junior World Cups	o.51
Zonal Championship	o.52
Olympic Games	o.53
Regional Games	o.54

## Chapter 3. Entries

Senior, Junior, World Championships, Zonal championships	o.55-60
Grand Prix, Senior and Junior World Cups, and Satellite competitions	o.61-62
<del>Veterans World Championships</del>	<del>e.63</del>
Olympic Games	o.64
Regional Games	o.65

## Part C – Procedures during Competitions

### Chapter 1. Formulae

<b>Individual Competitions</b>	o.66
A. General rules for the round of pools	o.67-75
B. General rules for the direct elimination	o.76-82
C. Mixed formula A. World Championships, Senior World Cups and Grand Prix	o.83-88
D. Mixed formula B.	o.89-94
E. Formula C. Olympic Games, Regional Games	o.95-96

### Team Competitions

A. Senior and Junior World Championships, Zonal Championships	o.97-99
B. Senior and Junior Team World Cups	o.100-102
<del>C. Veterans</del>	<del>e.103</del>
<del>D.C.</del> Olympic Games	o.104

<b>Chapter 2. Video Refereeing</b>	o.105
------------------------------------	-------

<b>Chapter 3. AntiDoping</b>	o.106-107
------------------------------	-----------

## Part D – Procedures after the Competitions

### Chapter 1. Ranking

Official FIE individual ranking	o.108
Official team ranking of the FIE	o.109

Chapter 2. Nations' Grand Prix Ranking o.110

## PART E - VETERANS

Organising Committee Veterans	o.111
Appointment of Refereeing, SEMI and Medical Delegates Veterans	o.112
Refereeing	o.113
AGE OF PARTICIPANTS	o.114
PRE-COMPETITION PROCEDURES	
PROGRAMMING	
VETERANS WORLD CHAMPIONSHIPS	o.115
INVITATIONS	o.116
ENTRIES	
Veterans World Championships	
Entries for competitions	o.117
Composition of the pools for the individual Veterans Championships	o.118
VETERANS TEAM EVENTS	o.119

**Veterans Council:** In favour.

**Rules Commission:** In favour after correction of the numbering ((PART ~~G~~ E – VETERANS).

**Opinion of the Executive Committee:** In favour of the proposal.

---

**Article:** Index to Articles

**Proposal from:** Rules Commission

**Motivation:** -

P. 18

## INDEX TO ARTICLES (Organization rules)

Numbers refer to articles of the Rules.

Accident: o.71, o.99 (see TECHNICAL RULES)

Addition of fencers after the dead-line: o.56.4, o.61.4/5, o.63.2, o.67.2

Age of participants: o.7, o.29, o.30, o.75, 0.103

A Grade competitions: see «World Cup»

A Grade Referee: o.4, o.25

Announcement

-change of member of team: o.99

-number of fencers in the final: o.81

-number of fencers promoted from pools: o.72, o.86, o.90

Anti-doping: o.4, o.21.2, o.106, o.107  
 Apparatus: ~~o.4~~ o.27.4, o.78.2; (see TECHNICAL RULES & MATERIAL RULES)  
 Appeals (against a decision): o.22; (see TECHNICAL RULES)  
 Assault: o.5  
 Attribution of Directoire Technique: see «Directoire Technique»  
 Attribution of referees: see «Referee (attribution)»  
 Auxiliary personnel: o.27  
 Barrage: o.74.3, o.86.2  
 B Grade Referee: o.4.3, o.25.1  
 Bureau of the FIE: o.12  
 Bout (meaning): o.5  
 Bout (score-sheet): o.27.1, o.99.4; (see TECHNICAL RULES)  
 Bout (duration): (see TECHNICAL RULES, ~~t.38, t.40, t.41~~ t.21.4, t.44.4, t.62.3, t.127, t.128)  
 Bout (end): (see TECHNICAL RULES, ~~t.38, t.40, t.41~~ t.21.4, t.44.4, t.62.3, t.127, t.128)  
 Bout (interruption): o.71  
~~Bout (number): o.73; see also «Indices»~~  
 Bout (number of hits): o.73.2.d, o.103.5; (see TECHNICAL RULES, t.38, t.40, t.41.4)  
 Bout (order): o.69-71, o.70, o.71, o.80, o.99  
 Bout (for third place): o.82, o.88, o.94  
 Bout (rest between): see «Time (between bouts)»  
 Bout (timetable): o.33.1, o.77  
~~Bout Committee: see «Directoire Technique»~~  
 Cadets: o.11, o.29.2, o.37, o.38, o.48, o.58, o.59, o.89, o.105, o.110  
 Calling (bouts): o.80  
 Calling (fencers — initial): (see TECHNICAL RULES, t.22, t.47, t.118, t.119, t.170)  
 Candidates (championships/competitions): o.48  
 Category A (competitions): see (World Cup)  
 Central Office of the FIE: o.11, ~~o.12, o.22~~, o.107.8; (see TECHNICAL RULES, t.143)  
 Championships: o.9  
 Change (in order of bouts): see «Bout (order)»  
 Circumstances outside control: o.16.1, o.19.3, o.20.1, o.21.1, o.56, o.87.3, o.99  
 Classification: see «Indices»  
     -after the pools: o.73, o.76, o.82.5, o.86  
     -FIE: o.68, o.85.3, o.87.1, o.108-110  
     -general: o.73, o.79, o.82, o.88, o.94  
     -Individual World Championships: o.108  
     -Team World Championships: o.109  
     - table: o.73, o.76  
     -teams: o.98, o.101  
 Clock: o.78  
 Coefficient (FIE ranking): o.108.2, o.109.2  
 Competition formula: o.41, o.42.4, o.66~~ss~~, o.83-88, o.89-94, o.95, o.96, o.97-99, o.100-102, o.104  
 Competitions (general rules): o.1-3  
~~-A Grade: see «World Cup»~~  
     -individual: o.66-96  
     -team: o.97-103  
 Composition: see «Team», «Pool»  
 Confirmation of participation: o.56 ~~o.85~~  
 Continental zone: o.42, o.52, o.89-94, o.97-99, o.100, o.105, o.108-109  
 Control (doping): see «~~Testing (anti-doping)~~»  
 Control by FIE: o.12, o.48, o.54, o.107.2  
~~Coup double: see Technical Book, t.38~~  
 Criteria for World Cup: see «World Cup»  
 Deadlines (equipment checking/displaying first round): o.35  
 Deadlines (sending out invitation/pre-programme): o.46-47, o.51-53  
 Deadlines (entries): o.55-56  
 Deadlines (referee entries): o.25  
~~Deciding hit: see Technical Book, t.38, t.40, t.41~~  
 Discipline: o.12.2, o.17.4, o.20.4, o.107.1  
 Direct elimination: o.5, o.16, o.66, o.76-82, o.83-88, o.86s, o.89-94, o.98, o.102, o.103.7, o.108.2.f

Direct elimination table: see «Table (direct elimination)»  
 Directoire Technique: o.11, o.12, o.14, o.27, o.15-17, o.38, o.48, o.50.2, o.54.1, o.63.3, o.67.1, o.70.2, o.72, o.87.6, o.99.5/8  
 Display (decisions of the Directoire Technique): o.15.4, o.27, o.38.2  
 Display (pools, direct elimination, scores): ~~o.20, o.27, o.35, o.77, o.85~~  
     -first round of pools: o.35 (see TECHNICAL RULES)  
     -score: o.27  
 DNF: o.74.3, o.79  
 DNS: o.74.1  
 Doctor: o.4.9, o.61.1, o.101; (see TECHNICAL RULES t.45, t.116, t.170)  
 Doping: o.4, o.21.2, o.106, o.107  
 Drawing lots (individuals when indices equal): o.68, o.73, o.85-86  
 Drawing lots (non-classified teams): o.98, o.102  
 Drawing lots (order for pool or match sheet): o.68, o.99, o.103  
 Drawing lots (to decide winner if scores equal): o.73; (see TECHNICAL RULES, t.38, t.40, t.41)  
 Drawing lots (in pairs): o. 87, o.102  
 Drugs: see «Anti-doping»  
~~Display (decisions of the Directoire Technique): o.15, o.27~~  
~~Display (pools, direct elimination, scores): o.20, o.27, o.35, o.77~~  
~~Doctor: o.4, see TECHNICAL RULES~~  
~~Doping: o.4, o.106s, o.107~~  
~~Drawing lots: individuals when indices equal: o.73, o.85ss~~  
~~-non-classified teams: o.98, o.102~~  
~~-order for pool sheet: o.68~~  
~~-on the match score sheet: o.99~~  
~~-in pairs: o. 87, o.102~~  
~~to decide winner if scores equal: see Technical Book, t.38, t.40, t.41~~  
~~Drugs: see «Anti-doping»~~  
 End of bout: o.99, o.20.4; (see Technical Book, t.38, t.40, t.41, t.42, t.21.4, t.44.4, t.62.3, t.127, t.128)  
 Entries: o.17, o.31, o.41.2.b, ~~o.46ss, o.51, o.55ss~~, o.56-57, ~~o.58s, o.62, o.63~~, o.59-64, o.85.2, o.87.2  
 Entry fee: o.24.2, o.26.2, o.48, o.50.2  
 Entry form: o.55-56  
 Equality (of indices): o.73, o.85.5, ~~o.85ss~~, o.103  
 Equality (of points): o.108, 1.d, o.109.2.b, o.110  
 Equality (of ranking): o.82, o.85.5, o.88, 0.94, o.103  
 Equality (score at end of time): (see TECHNICAL RULES, t.38.2, t.40.3, t.41.5, t.62.3, t.124)  
 Equipment (checking): o.19.2, o.28, o.34, o.54.2  
 Equipment (organisation): o.4.4, o.10  
 Excluded: o.74.3, o.79  
 Exclusion (fencer): o.99.7.b  
 Executive Committee: o.13, o.16, o.18, o.22.5, o.23-o.24, o.26, o.32, o.48, o.50, o.54, o.96, o.104, o.107.10  
 Exemptions: o.85, o.86.2, o.87, o.108.1.f; see «Seeding»  
 Experts (electrical equipment): o.27  
 Expiry of time: see «Equality (score at end of time)», «End of bout», «Time (of bout)»  
 Extra minute: see «Equality (score at end of time)»  
 Fencers (obligations of): see «Obligation(s)»  
 FIE delegates: o.15-23  
 FIE Junior Ranking: o.38, o.98.2, o.102, o.108, o.109  
 FIE Ranking: o.4, o.38, o.68, o.85.5, o.98.2, o.102, o.108-110, o.109, o.110  
 FIE Supervision: o.12, o.17, o.21, o.22, o.27.3  
 FIE Supervisor: o.22-23  
 Finals (of competitions): o.4, o.27.1, o.33.2, o.66, o.83, o.89, o.93 o.81; (see TECHNICAL RULES)  
 Fine: o.25, o.31, o.51, o.52, o.56, o.61, o.87.3, o.85  
 Forbidden substances: o.107; see «Anti-doping»  
 Force majeure: o.56.3, o.61.2/5, o.85.4, o.87.3, o.99.6  
 Functions of the Referee: see «Referee»  
 Grand Prix (competitions): o.22.1, o.26, o.40, o.61, o.62, o.67.3, o.83-88, o.105.1, o.108  
 Grand Prix (nations): o.110  
~~Hits (decisive): see Technical Book, t.38, t.40, t.41~~  
~~Hits (double): see Technical Book, t.38~~

Hits (number): o.73.2.d, o.103.5; (see TECHNICAL RULES, t.38, t.40, t.41.4)  
 Hits (received): o.73; see «Indices»  
 Hits (scored): o.73, o.99.4; see «Indices»  
~~Illness: o.104~~  
 Indices: o.73, o.86, o.87.4/5, o.93.1, ~~o.98~~,  
 Individual: see «Competitions (individual)»  
 Injury: o.21.2.c, o.61, o.99.6, o.101, o.103; (see TECHNICAL RULES, t.21.4, t.45, t.170)  
 International officials: o.48, ~~o.49~~, o.50.2  
 Interruption of a bout: o.71  
 Invitation: o.46-47, o.51-53, o.55  
~~Lap: see TECHNICAL RULES t.41~~  
 Licence: o.2, o.29.1, o.31, o.61.6, o.63.4  
 Match: o.6-7, o.19.4, o.27.1, o.33, o.41.2.c, o.82.2/3, o.88, o.94, o.97, o.99, o.101, o.103, o.105  
 Medical delegate: o.18, o.21, o.48, o.99, o.103  
 Medical reason: o.21.2.c, o.61, o.99.6, o.101, o.103  
 Nationality of fencers: o.67.2, o.68.2, o.70.3, o.76  
 Neutrality: o.27.1, o.44.4; see «Referee»  
 Notice-board: o.15.4  
 Number of participating countries (minimum): o.4  
 Number of fencers: o.25.1, o.56, o.57, o.59, o.60, o.62, o.67.2, o.70, o.72, o.86; see «Entries», «Team», «Quotas (of fencers for World Cup competitions)»  
 Number of hits: see «Hits»  
 Obligation (to confirm participation): o.56s, o.85, o.87  
 Obligations (of organizers): o.4, o.10, o.22.1, o.24.2, o.26.1, o.27~~ss~~, o.28, o.32, o.34, o.52, o.54, o.77, o.85.2, o.106  
 Obligations (of Directoire Technique): ~~o.15ss~~ o.15-17, o.27, o.38, o.50.2.6, o.54.1, o.63.3, o.67.1, o.70.2, o.71.1, o.72, o.87.6, o.99.8  
 Observer (FIE): see «Supervisor»  
 Official competitions of FIE: o.1-3; see «World Cup», «World Championships», «Olympic Games»  
 Official FIE rankings: o.4, o.38, o.68, o.85.5, o.98.2, o.102, o.108s, o.109, o.110  
 Olympic Games: o.3, o.11, o.12, o.16.1, o.20.3, o.35, o.43, o.53, o.64, o.66.c, o.95, ~~o.97ss~~, o.104-105, o.108~~ss~~-109  
 Open World Championships: see «World Championships»  
 Order of bouts: o.69-71, o.80, o.99  
 Organisation of competitions: ~~o.10ss, o.17~~ o.10-27  
 Organising Committee: o.10, o.13, o.24. o.46, o.48.2, o.50.2, o.54, o.56  
 Participants: see «Entries», «Quotas (of fencers for World Cup competitions)»  
 Penalties (financial): o.25.2, o.31, o.56.3/4, o.61, o.85.4, o.87.3  
 Period (direct elimination bout): o.5, o.78.2; (see TECHNICAL RULES, t.39)  
 Phase: o.74.3, o.85-87, o.103, o.105  
 Piste: o.4.6/7, o.17.3.d, o.87.1, o.80.2, o.93.2, o.105; (see TECHNICAL RULES & MATERIAL RULES)  
 Points: o.41, o.75, o.101; see «Scale of points»  
 Pool (composition): ~~o.4~~, o.35, o.38, o.67-71, o.75, ~~o.82~~, o.86, o.90  
 Position of fencers in pools: see «Order of bouts», «Pool»  
~~Posting: o.35, o.77~~  
 Preliminary phase (direct elimination): o.83, o.85-87  
 President (of the FIE); o.12-13, o.48.2.c, 50.2.c  
 President (Directoire Technique): o.16.1.c, o.17.4  
 Prize winners: o.108.3  
~~Problem: o.20~~  
 Programme of events: o.32-33, o.36-37, o.39, o.43  
 Protests: o.20.2.d; see «Appeals»  
 Publish (of pools, direct elimination): o.30, o.77, o.85.2; see «Display (pools, direct elimination, scores)»  
 Qualification of fencers: o.30, o.66, o.72-73, o.82-83, o.86-86, o.89, o.90, o.93  
 Quarter (of direct elimination table): o.80, o.87, o.93.2  
 Quarter finals: o.61.1, o.102.2  
 Quotas (of fencers for World Cup competitions): o.62  
 Rankings (individual): o.67-68, o.72-73, o.75, o.82.4, o.86.2, o.105, o.108  
 Rankings (team): o.98, o.99.7, o.102-103, o.105, o.109-110  
 Referee: o.4.3, o.24-27 ~~o.25, o.26~~, o.48.2.f, o.50.2.f, o.54.4, o.61.6, o.71s, o.99.5.a, o.103.6

Referee (Junior World Cup & Satellite events): o.25  
 Referee (attribution): o.17, o.24, o.54  
 Refereeing (Committee/Commission): o.18, o.20, o.24, o.26, o.48.2, o.50.2, o.54  
 Refereeing (delegates): o.18, o.20, o.22, o.54.3 ~~o.67, o.70~~  
 Regional games: o.13, o.44, o.54, o.96  
 Relay: o.5, o.41.2.c, o.99, o.103,2/4; (see TECHNICAL RULES, t.41)  
 Repairer (electrical equipment): o.27.4  
 Replacing fencer: o.56.4, o.61, o.97, o.99.5/6, o.103  
 Reserve: o.42.5, o.60, ~~o.61~~, o.97, o.99, o.103  
 Rest: o.33.1, o.71.2, o.78.1, o.80.3; see «Time (between bouts)»; (see TECHNICAL RULES, t.39, t.42)  
 Result: see «Score»  
 Round (direct elimination table): o.80, o.82.3, o.86-87, o.89, o.93, o.98.3, o.102-103, o.108.2.f  
 Round (pools): o.4.6, o.35, o.39.3, o.66-67, o.82.4/5, o.83, o.86, o.87.5, o.89, o.92-93, o.103; see «Pool»  
~~Sabre: o.36s~~  
 Satellite: o.3, o.25, o.45, o.51, o.61, o.108  
 Scale of points: o.108, o.109  
~~Score: see Technical Book, t.38, t.40, t.41~~  
 Score (sheet): o.17.1, o.27.1, o.68.3, o.70, o.99.4; (see TECHNICAL RULES, t.38, t.40, t.41, t.45.1, t.50.7, t.124, t.163, t.168)  
 Score-board (for finals): o.27  
 Scorers: o.27; (see TECHNICAL RULES, t.47)  
 Seeding: o.38, o.73, o.85-89, o.108.1.f  
 SEMI (Committee): o.4, o.18, o.22.3, o.28, o.48.2.c, o.50.2.c, o.54.2  
 SEMI (Delegate): o.18-19  
 Semifinals: o.82, o.88, o.94, o.103  
~~Senior World Championships: see «World Championships»~~  
 Senior World Cup: o.18.3, o.26.2, o.41, o.51, o.61, o.83, o.100, o.105, o.109.2  
 Signs (names of fencers): o.4.7  
 Specialist (personnel): o.27-28  
 Specification ('Cahier de charges'): o.4, o.10  
 Substitution of a team member: o.44.2b, o.56.2, o.61.3, o.99.5, o.103; see «Replacing fencer»  
 Superintendent of the apparatus: o.27  
 Supervisor: o.22, o.23  
 Table (direct elimination): o.5, o.17, o.66, o.76ss, o.86ss, o.89ss, o.98ss, o.102, o.103.7, o.108.2.f  
~~Table (time of drawing): o.102~~  
 Team (composition): o.41, o.97ss, ~~o.109~~  
 Team (captain): o.15, o.99, o.103  
 Team (classification): o.98, ~~o.104~~ o.102-103  
 Team (replacement of a fencer): o.99  
 Technical delegate of the FIE: o.13  
 Testing (anti-doping): o.4, o.21.2, o.106, o.107  
 Third (place): o.82, o.88, o.94, ~~o.98~~  
 Tie (equal scores): o.73, o.108-110; (see TECHNICAL RULES, t.38.2, t.40.3, t.41.5, t.62.3, t.124)  
 Tie (seeding/indicators): o.73, o.85-87  
 Tie (third place): see «Third (place)»  
 Tie (world rankings): o.108-110  
 Time (between bouts): o.71, o.78, o.80.3; (see also TECHNICAL RULES, t.39, t.42)  
 Time (maximum participation for fencer): o.33  
 Time (of bout): see Technical Book, t.38, ~~t.40~~, t.41  
 Time-keeper: o.27  
 Timetable: o.15.4, o.20, o.3533ss, o.77, o.105  
 Tournament: o.8  
 Video refereeing: o.105  
 Website, FIE: o.25.1, o.56.2, o.61.1, o.85.2  
 Withdrawal: o.61.2, o.74, o.79, o.99.7  
 World Cup: o.3, o.4, o.16.2, o.18.2, o.22, o.25, o.26, o.41, o.51, o.61, o.62, o.67.2, o.83, o.89, o.100, o.105, o.108-109  
     - Individual World Cup: o.61, o.62, o.83, o.89, o.105, o.108  
     - Junior World Cup: o.25, o.41, o.51, o.61, o.89, o.100  
     - Team World Cup: o.26.2, o.41, o.61, o.100, o.105, o.109

World Championships: o.11-12, o.16.3, o.18.2, o.20.3, o.24, o.26, o.31, o.35-36, o.37-39, ~~o.39~~, o.47-48, o.50.1, o.55-59, o.63, ~~o.75~~, o.103, o.105, o.108, o.109, o.110

- Cadet World Championships: o.11, o.37-38, o.48.1, o.58-58, o.89-96, o.105.4

- Junior World Championships: o.11, o.30, o.35, o.37, o.48, o.59, o.97, o.89.3, o.105, o.108.2/3, o.109.3

- Senior World Championships: o.35-36, o.48, o.55, o.57, o.105, o.108-109

- Veteran World Championships: o.11, o.16.3, o.18.4, o.26, o.29, o.39, o.63, o.50, o.75, o.103

World Championships (formula):

- Senior individual events: o.83-88

- Junior and Cadet events: o.89-96

- Team events: o.97-99

Zonal Championships:

- Junior: o.60, o. 89-96, o.100-102

- Senior: o.42, o.55, o.60, o.89-96, o.100-102, o.105, o.108.2.d

**Rules Commission:** In favour.

**Opinion of the Executive Committee:** In favour of the proposal.

---





**Proposals for the 2023 Congress**  
**Modifications of the Technical Rules**

The texts below are applicable on January 1st, 2024, unless mentioned otherwise.

**Article:** t.18

P. 19

**Proposal from:** Rules Commission

**Motivation:** In the last 2m of the piste, draw a line down the middle (1m). This allows the Referee to define more precisely the lateral exit of the foot(s) to judge whether or not the rear limit has been left.

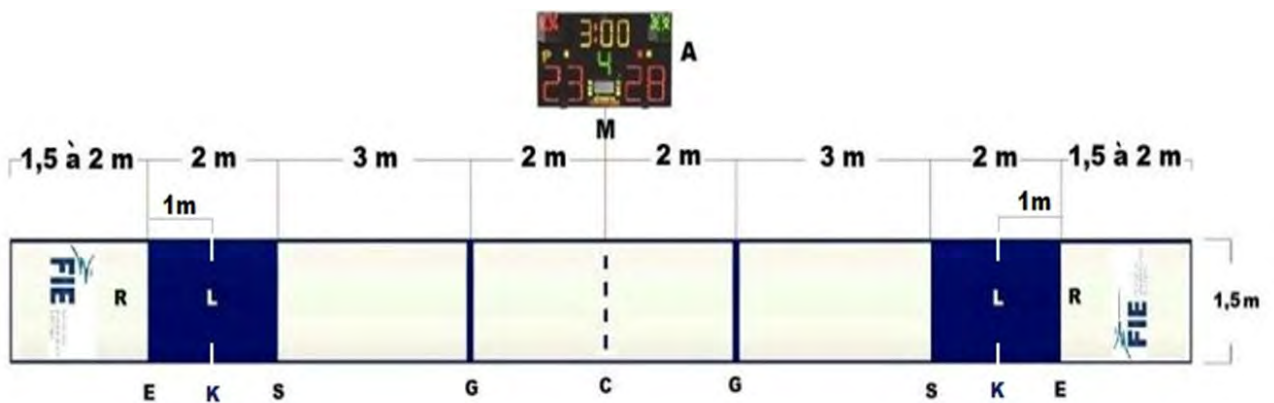
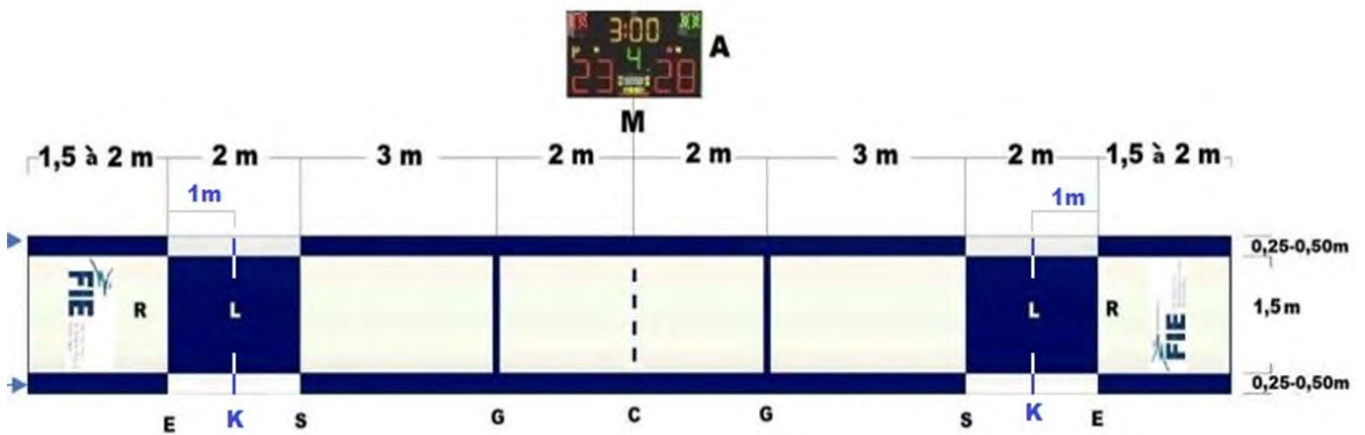

**Refereeing Commission:** Not in favour.

**SEMI Commission:** Not in favour. Unless the Referees Commission can justify the benefits versus the high cost and technical difficulties of altering existing pistes with conductive replacement sections

**Rules Commission:** Proposal deleted.

**Opinion of the Executive Committee:** The proposal has been removed by the Rules Commission and will not be dealt with.

---

P.20

**Article:** t.18.2

**Proposal from:** SEMI Commission

**Motivation:** Based on the experience on the field of play, the metal frames, when hooking one element to another, leave a gap of 2/3 mm, this means that a tolerance of 4 cm must be foreseen in the total length; the same tolerance has to be considered for the carpet piste because off the material is more stretching, so when the piste is fully extended, there may be a stretch of the material similar to the metal piste.

**t.18.2**

The piste is 14 metres long, with a total tolerance on the whole length of 4 cm, so that each competitor, being placed at 2 metres from the centre line, has at his disposal for retreating a total distance of 5 metres without it being necessary for him to cross the rear limit of the piste with both feet.

**SEMI Commission:** In favour.

**Rules Commission:** In favour.

**Opinion of the Executive Committee:** In favour of the proposal.

---

P.21

**Article:** t.23, t.25, t.26, t.27, t.29, t.35, t.43, t.45, t.55, t.71, t.73, t.76, t.90,

t.96, t.110, t.116, t.120, t.123, t.125, t.128, t.133, t.172.

**Proposal from:** Rules Commission

**Motivation:** Add and correct the groups of sanctions in the main article to be consistent with t.170

**t.23**

- 6 The Referee may not allow a fencer to **leave the piste**, save in exceptional circumstances. If a competitor does so without permission he is liable to incur the penalties enumerated in Articles t.158-162, t.165, t.170~~-,~~ [for the offences of the 1st group](#).

#### t.25

- 2 **At all three weapons** it is forbidden for a fencer to **cause corps à corps intentionally** to avoid being hit, or to jostle his opponent. Should such an offence occur, the Referee will penalise the fencer at fault as specified in Articles t.158-162, t.165, t.170~~-,~~ [for the offences of the 1st group](#) and any hit scored by the fencer at fault is annulled.

#### t.26

- 1 The 'flèche ending systematically in a corps à corps' referred to in this article must not be confused with the 'flèche resulting in a shock which jostles the opponent', which is considered as an act of **intentional brutality** at all three weapons and is punished as such (cf. t.121.2, t.170)~~-,~~ [for the offences of the 2nd group](#).

#### t.27

- 2 It is forbidden to **turn one's back** on one's opponent during the bout. Should such an offence occur, the Referee will penalise the fencer at fault as specified in articles t.158-162, t.165, t.170~~-,~~ [for the offences of the 1st group](#) and any hit scored by the fencer at fault is annulled.

#### t.29

- 1 The use of the **non-sword hand** and **arm** to carry out an offensive or defensive action is forbidden (cf t.158-162, ~~t.165,~~ **t.166**, t.170). Should such an offence occur, the hit scored by the fencer at fault is annulled and the latter will be penalized as specified for offences of the 2nd group (red card).
- 2 If a fencer **substitutes a non-valid part of his target for a valid part**, either by covering it or by any abnormal movement, the Referee must penalise him by applying the penalties specified in Articles t.158-162, t.165, t.170~~-,~~ [for the offences of the 1st group](#) and any hit scored by the fencer at fault is annulled.
- 3 During the fight, the fencer must not, under any circumstances, **take hold of any part of the electrical equipment** with his non-sword hand; [the referee imposes him/her the penalties for the offences of the first group](#) (cf. t.158-162, t.165, t.170); any hit scored by the fencer at fault is annulled.

#### t.35

- 3 A competitor who crosses one of the lateral boundaries of the piste with both feet — e.g. when making a flèche — **to avoid being hit** will be penalised as specified in Articles t.158-162, t.165, t.170~~-,~~ [for the offences of the 1st group](#).

#### t.43

- 2 Any fencer who attempts improperly to **cause or to prolong interruptions** to the bout is penalised as specified in Articles t.158-162, t.165, t.170~~-,~~ [for the offences of the 1st group](#).

#### t.45

- 3 Should a fencer **demand a break** which is deemed by the delegate of the Medical Commission or, in his absence, by the doctor on duty to be **unjustified**, the Referee will penalise that fencer as specified in Articles t.158-162, t.166, t.170 [for the offences of the](#)

2nd group.

#### t.55

- 2 A competitor who, **intentionally**, causes the apparatus to register a hit by placing his point on the ground or on any surface other than **that of his opponent** will be penalised as specified in Articles **t.158-162, t.165, t.166, t.170-**, for the offences of the 2nd group.

#### t.71

If a fencer appears on the piste:

- with only **one** regulation **weapon** (cf. t.114, 115); or
- with only **one** regulation **bodywire**; or
- with only **one** regulation **mask wire**; or
- with a **weapon or a bodywire which does not work** or which **does not conform** with the Rules; or
- without his **protective under-plastron** (cf. t.64.5); or
- with a **conductive jacket** which does not fully cover the valid target; or
- with a mask whose 2nd security device is not securely fixed to the body of the mask; or
- with **clothing** which does not conform with the Rules;

the Referee will apply the penalties stipulated in Articles t.158-162, t.165, t.170-, for the offences of the 1st group.

#### t.73

- 1 If, when a fencer appears on the piste or during a bout, it is established that the equipment used by the fencer:
- a) **does not bear the marks** applied at the preliminary check, the Referee will:
- annul the last hit, if any, scored by the fencer at fault;
  - penalise him as specified in Articles **t.158-162, t.166, t.170-**, for the offences of the 2nd group.
- b) does not conform to the rules in a way **not covered by the preliminary check**, the Referee will:
- penalise him as specified in Articles **t.158-162, t.166, t.170.**, for the offences of the 2nd group.

#### t.76

- 2 **Pushing or letting drag** the point of the electric weapon on the electric piste is forbidden during the actual bout (between 'Play!' and 'Halt!'). Placing the weapon on the piste at any time to **straighten** it is also forbidden. Any breaking of these rules will be punished according to Articles t.158-162, t.165, t.170-, for the offences of the 1st group.

#### t.90

- 2 **Pushing** or letting the point of the electric weapon **drag** on the electric piste is forbidden during the actual bout (between 'Play!' and 'Halt!'). Placing the weapon on the piste at any time to **straighten** it is also forbidden. Any breaking of this rule will be penalised according to Articles t.158-162, t.165, t.170-, for the offences of the 1st group.

#### t.96

- 3 It is forbidden to **hit with the guard**. Any hits registered by hitting with the guard must be

annulled, the fencer so hitting being penalised as specified in Articles t.158-163, t.165, t.170., for the offences of the 2nd group.

**5 Placing the weapon on the piste at any time to straighten it** is forbidden. Any breaking of this rule will be punished according to Articles t. 158-163, t.165, t.170., for the offences of the 1st group.

**t.110**

**Smoking** in competition halls is forbidden. Smoking will be considered as a disturbance of the smooth running of the competition (cf. t.111).

Any breach of these rules will be punished as laid down in Articles **t.158-162, t.167, t.168, t.170.** , for the offences of the 3rd group.

**t.116**

Under no circumstances should the fencers **dress or undress in public** except in the case of an accident duly recognised by the doctor on duty or by the representative of the Medical Commission (cf. **t.126, t.158-162, t.165, t.170.**)-, Any infringement will be sanctioned for the offences of the 1st group.

**t.120**

Should a fencer **abandon a bout** by leaving the piste (cf. **t.23.6**), he will be penalised as specified in Articles **t.158-162, t.165, t.170.** , for the offences of the 1st group.

**t.123**

During or after a bout, even if the fencer has already left the piste, any act against the spirit of sportsmanship such as violently or dangerously throwing one's mask or any other piece of equipment will be penalised as specified in article **t.169 (c.f. t.108.1, 2 and t.109)**- , for the offences of the 4th group.

**t.125**

The fencer, whether on or off the piste, must **keep his mask on** until the Referee calls 'Halt!' He may under no circumstances address the Referee until the Referee has made his decision (cf. **t.158- 162, t.165, t.170)**- , Any infringement will be sanctioned for the offences of the 1st group.

**t.128**

Competitors must **fence to their utmost ability** in a sportsmanlike manner until the end of the competition in order to obtain the best possible classification, without giving away hits or seeking to be favoured by being given hits by anyone (cf. **t.158-162, t.169, t.170)**- , Any infringement will be sanctioned for the offences of the 4th group.

**t.133**

Spectators are obliged not to **interfere with the good order** of a competition, to do nothing which may tend to influence the fencers or the Referee, and to respect the decisions of the latter even when they do not agree with them. They must obey any instructions which the Referee may deem it necessary to give them (cf. **t.109-110, t.167-168, t.170)** . , the penalties for the offences of the 3rd group.

**t.172**

- 2 If a fencer infringes this principle, **casting doubt** on the decision of the Referee **on a point of fact** during the bout, he will be penalised according to the rules (cf. **t.158-162, t.165, t.170)**- , for the offences of the 1st group. But if the Referee **is ignorant of or misunderstands a definite rule**, or applies it in a manner contrary to the Rules, an appeal on this matter may be entertained. A point of fact includes, but is not limited to, any ruling by the referee analysing what happened on the piste, such as the validity or priority of a hit, whether a fencer left the

side or end of the piste or if a person's behaviour is a Group 3 or Group 4 offence.

**Rules Commission:** In favour.

**Refereeing Commission:** not in favour of the additional text concerning a group of penalties but in favour for correctness of article numbers as below :

**t.29**

1 The use of the **non-sword hand** and **arm** to carry out an offensive or defensive action is forbidden (cf t.158-162, ~~t.165~~, **t.166**, t.170). Should such an offence occur, the hit scored by the fencer at fault is annulled and the latter will be penalized as specified for offences of the 2nd group (red card).

**t.55**

2 A competitor who, **intentionally**, causes the apparatus to register a hit by placing his point on the ground or on any surface other than **that of his opponent** will be penalised as specified in Articles **t.158-162**, ~~t.165~~, **t.166**, **t.170**, ~~for the offences of the 2nd group~~.

**Opinion of the Executive Committee:** In favour of the proposal of the Rules Commission.

---

**Article:** **t.35**

P.22

**Proposal from:** Rules Commission

**Motivation:** Add in t.35.3 the cancellation of the fencer's hit to be consistent with t.170

**t.35**

3 A competitor who crosses one of the lateral boundaries of the piste with both feet — e.g. when making a flèche — to avoid being hit will be penalised as specified in Articles t.158-162, t.165, t.170. **Any hit made by the offending fencer is annulled.**

**Rules Commission:** In favour.

**Refereeing Commission:** not in favour as it is clear in the rules:

**t.33.2** If the fencer goes off the piste with both feet, the Referee must annul everything that has occurred after the boundary has been crossed, except a hit received by the competitor who has crossed the boundary even after he has crossed it, provided that this hit results from a simple and immediate action.

**Opinion of the Executive Committee:** In favour of the proposal.

---

**Article:** t.41

P.23

**Proposal from:** Rules Commission

**Motivation:** In epee, the first two opponents can both reach the score of 5 hits by a double hit.

### Team competitions

t.41

2 The first two opponents fence until one **or both of them have** scored five hits, within the time limit of 3 minutes.

The next two opponents fence until one **or both\*** of their scores has reached ten hits, within the time limit of 3 minutes, and so on with successive bouts, cumulatively, of five hits.

\*this modification occurs in English only

**Refereeing Commission:** In favour.

**Rules Commission:** In favour, but with the new correction.

2 The first two opponents fence until one **or both of them have** scored five hits, within the time limit of 3 minutes.

The next two opponents fence until one **or both\*** of their scores has reached ten hits, within the time limit of 3 minutes, and so on with successive bouts, cumulatively, of five hits.

(Correction valid only in English).

**Opinion of the Executive Committee:** In favour of the proposal as revised by the Rules Commission.

---

**Article:** t.45

P.24

**Proposal from:** Rules Commission

**Motivation:** It is incomprehensible that for a match or a round of 3 min. a medical break of 5 min. can be given, so the medical break time exceeds the time of a match.

If it is a real injury then the athlete cannot continue because the health of the athlete is much more important than the competition. 3 minutes is enough time to diagnose if the athlete wants to continue or if it is an injury that can be managed very quickly.

A great majority of athletes now use the 5 minutes as a tactical break and especially when the athlete is in difficulty either physically or when he is behind in the score, and this is a kind of cheating and it is necessary to safeguard our sport from these practices. We have found ourselves in many situations where the athlete uses the 5 minutes much more to be able to recover physically or to stop the progress of the opponent.

In other individual sports, the medical break does not exceed 3 minutes in the most mediatized sports, because it is considered that if the athlete is injured, he cannot be healed during a medical break, so he must leave the competition because his health is much more important.

For example, in tennis, the individual sport with the most media coverage in the world, the athlete has the right to only one break for a match that can last 3 or even 4 hours, this break is 3 minutes, in judo the athlete does not have the right to any break, it is the direct intervention of the doctor who must determine if he can continue or not, if the athlete must be touched to intervene has an injury, it is considered that it is a serious injury and the athlete must leave the competition because in judo it is considered that the state of health of the athlete is much more important than the competition in itself

It is necessary to change the concept of the medical intervention. We propose that, on request of the referee, the doctor can intervene directly or on request of the official doctor and the 3 minutes are counted as soon as the intervention is done by the doctor of the team, the delegate his role is to diagnose if the athlete wants to continue or not in a maximum time of 3 minutes. These 3 minutes are valid only once per match. As in the boxe, the official doctor intervenes only to decide if the athlete can continue or not.

We suggest to make the test during the 2024 Junior and Cadet World Championship in Saudi Arabia, the 3 minutes of medical break will be applicable from the season 2024/ 2025 from September 2024.

#### **t.45**

1. For any injury or other medical reason which occurs in the course of a bout and which is properly attested by the delegate of the FIE Medical Commission or, in his/her absence, by the doctor and/or medical provider on duty, ~~the Referee will allow a break in the fight~~ lasting no longer than ~~5~~ 3 minutes. ~~Only the doctor and/or medical provider on duty can determine the length of time of treatment required when a medical time-out is granted.~~ This break should be timed from the intervention of the delegate of the FIE Medical commission or, in his absence, ~~of~~ the doctor. ~~gave his opinion~~. This break should be strictly reserved for the requisite treatment. If the delegate of the FIE Medical Commission or, in his absence, the doctor on duty considers, before or at the end of the ~~5~~ 3 minute break, that the fencer is incapable of continuing the fight, he/she will decide that the fencer should retire (individual events) and/or be replaced, if possible (team events) (cf. o.99.6.a/b).

**Rules Commission:** In favour.

**Medical Commission:** The Rules Commission has proposed an amendment to Article: t.45 to reduce the duration of a medical timeout from five minutes to three, based on the belief that the existing rule is occasionally or often misused by athletes for strategic advantage. They suggest trialing this rule change at the 2024 Junior and Cadet World Championship in Saudi Arabia.

While the Medical Commission recognizes the need to prevent misuse of medical timeouts, the proposal was **unanimously rejected** due to the lack of empirical evidence supporting the claim of misuse and potential compromise on athlete health due to reduced time for medical evaluation and



treatment. Additionally, the proposed three-minute medical intervention period may not offer sufficient flexibility to manage diverse medical situations effectively.

The Commission acknowledges the need for an evidence-based approach to such decisions. To this end, there is significant potential to collect and analyze data across FIE events. Recording and examining crucial data points—such as strip calls, medical timeouts (awarded and denied), quick interventions, time taken to award a timeout/medical assessment and intervention/treatment duration, athlete's country, handedness, and bout score at injury time and which opponent was down in correlation to injury request—can create a substantial evidence base.

This approach aligns with the IOC Consensus Statement of 2020 and provides crucial epidemiological insights into sport-specific injuries. It also offers an excellent opportunity to improve the quality of medical coverage at over 97.5% of international events through targeted training for local organizers and healthcare professionals. This strategy could encompass a brief 10-15 minute educational presentation and a subsequent quiz, enhancing adherence to FIE competition rules and reducing medical assessment and treatment times.

In conclusion, while the motivation behind the proposed amendment to Rule t.45 is understood, it requires comprehensive, empirical data to underpin any modifications. The Commission believes that capturing and analyzing pertinent data from FIE events, and bridging educational gaps among local organizers and medical staff, will serve the interests of athlete health, ensure fairness, and improve the effectiveness of the rules across all competitions. Such an ambitious proposal has a strong endorsement from the Medical Commission and would be interested in a joint proposal to the executive committee to improve the healthcare quality of and running of international events.

**Athletes Commission:** Disagree, leave the medical break at 5 minutes.

**Opinion of the Executive Committee:** Agrees with the Medical Commission's comments on health risks. **Not in favour** of the proposal.

---

**Article:** t.56.3

P.25

**Proposal from:** Refereeing Commission

**Motivation:** Remove t.47.2 (Duties of referees) from t.56.3

**t.56.3**

A competitor who makes any modification in or who changes his equipment without being asked by the Referee to do so, before the Referee has given his decision, loses all right to the annulment of the hit (cf. t.47.2.d).

**Refereeing Commission:** In favour.

**Rules Commission:** In favour.

**Opinion of the Executive Committee:** In favour of the proposal.

**Article:** t.56 and t. 170

P.26

**Proposal from:** Refereeing Commission

**Motivation:** intentional dropping the weapon during the bout should be penalized stronger and added to the second group of penalties.

11. A competitor who, intentionally drops weapon during the fencing phrase will be penalized as specified in Articles t.166, t.170. However, a hit scored by the opponent is valid, provided that the action was started before the 'Halt!'.

	2nd group		1st offence	2nd offence	3rd offence and subseq.
2.1	Use of non-sword arm/hand *	t.29.1, t.30	RED	RED	RED
2.2	Demanding a break for medical reason deemed unjustified by doctor	t.45.3			
2.3	Absence of weapon control marks *	t.73.1a			
2.4	Intentionally dropping a weapon during the fencing phrase	t.56.11			
2.5	Deliberate hit not on opponent *	t.55.3			
2.6	Dangerous, violent or vindictive action, blow with guard or pommel *	t.121.2, t.147, t.149.1			

**Refereeing Commission:** In favour.

**Rules Commission:** In favour.

**Opinion of the Executive Committee:** In favour of the proposal.

**Article:** t.61

P.27

**Proposal from:** Rules Commission

**Motivation:** To clarify the use of video refereeing in the pool phase of the Zonal Qualifying Event for the O.G.

Appeals for Video Refereeing

**t.61**

In the individual events, the fencer has :

- in pools, ~~one possible appeal during each bout;~~ only in the zonal qualifying event for the Olympic Games is video refereeing compulsory in the pools. The fencer has only one possibility of appeal in each period.
- in **direct elimination bouts**, two possible appeals.  
Should **the referee agree with the fencer** who appealed for the video-refereeing, the latter is entitled to retain the right of appeal.

**Refereeing Commission:** Not in favour as it is clear in FIE Organisation rules o.105.5.

**Rules Commission:** In favour, but with the new correction.

1 In the individual events, the fencer has:

in pools, one possible appeal during each bout; (Cf. o.105, zonal qualification for Olympic Games). ~~only in the zonal qualifying event for the Olympic Games is video refereeing compulsory in the pools. The fencer has only one possibility of appeal in each period.~~

**Opinion of the Executive Committee:** In favour of the proposal as revised by the Rules Commission.

---

**Article:** t.64 and t.170.4.1

P.28

**Proposal from:** Fencing Federation of Jamaica

**Motivation:** The motivation for this proposal is to enable fencers and federations who are unable to provide a coach at a competition to have access to a coach via virtual means in the future. This would help to level the playing field by removing financial and resource constraints that can limit a fencer's opportunities. By providing virtual coaching, fencers would have access to guidance and support that they might not otherwise have, which would help them to perform at their best and reach their full potential. Ultimately, this proposal aims to promote greater inclusivity and equity in fencing, allowing more athletes to participate and compete on a fair and equal footing.

Insert item #7

**Regulation equipment and checking of equipment by the referee**

## t.64

7. the virtual coaching mechanism is activated, and in the unobstructed designated area for coaches.

## t.170, 4.1

Fencer equipped with electronic communication equipment permitting them to receive communications during bout, unless previously authorized virtual coach device to communicate with fencer during authorized moments, in coaching area.

**Refereeing Commission:** Not in favour.

**Coaches Council :** Not in favour.

t.64. The referee should check the fencers' equipment before the bout. No electronic communication equipment is allowed for communication during the bout.

But nothing stops the fencer, coach, administrator, or anybody else from using any communication equipment between the bouts or during the one-minute break in Direct Elimination when the fencer can have advice from the coach.

If it is unclear to the referees, we should ask the rules commission to make the necessary adjustments.

**SEMI Commission:** Not in favour, require further verification of systems to be used.

**Athletes Commission:** Agree in theory - but change the language to clearly state: the authorized time is during the one-minute breaks. The athlete should not be allowed to listen to their coach during the fencing. Specify what the mechanism is.

**Rules Commission:** Not in favour.

**Opinion of the Executive Committee:** Not in favour of the proposal as it is drafted because it seems to involve practices that are currently forbidden and sanctioned during the bout.

---

**Article:** t.70

**Proposal from:** Rules Commission

**Motivation:** Add m.11 Fixation of the tip to t.70 material not in conformity.

### *Non-standard equipment*

#### t.70

In whatever circumstances a fencer on the piste is found to be in possession of equipment which is non-regulation or defective (cf.m.8, m.9, m.11, m.12, m.13, m.16, m.17, m.23), the referee confiscates the equipment and submits it to the experts on duty for examination. The equipment in

question will only be returned to the owner after the measures necessitated by this examination have been completed and, if appropriate, after the payment of any expenses for repairs. The equipment must be rechecked before it is used again.

**Refereeing Commission:** Modify proposition as below:

**t.70**

In whatever circumstances a fencer on the piste is found to be in possession of equipment which is **non-regulation or defective in accordance with FIE Material rules (cf.m.8, m.9, m.11, m.12, m.13, m.16, m.17, m.23)**, the referee confiscates the equipment and submits it to the experts on duty for examination. The equipment in question will only be returned to the owner after the measures necessitated by this examination have been completed and, if appropriate, after the payment of any expenses for repairs. The equipment must be rechecked before it is used again.

**SEMI Commission:** In favour.

**Rules Commission:** In favour, with the new correction.

In whatever circumstances a fencer on the piste is found to be in possession of equipment which is **non-regulation or defective (cf.m.8, m.9, m.11, m.12, m.13, m.16, m.17, m.23) according to Material Rules)**, the referee confiscates the equipment and submits it to the experts on duty for examination. The equipment in question will only be returned to the owner after the measures necessitated by this examination have been completed and, if appropriate, after the payment of any expenses for repairs. The equipment must be rechecked before it is used again.

**Opinion of the Executive Committee:** In favour of the proposal as revised by the Rules Commission.

---

**Article:** t.77, t.91 and t.98

**Proposal from:** Rules Commission

**Motivation:** Update of the drawings concerning the valid target at the three weapons.

**t.77**

P.30

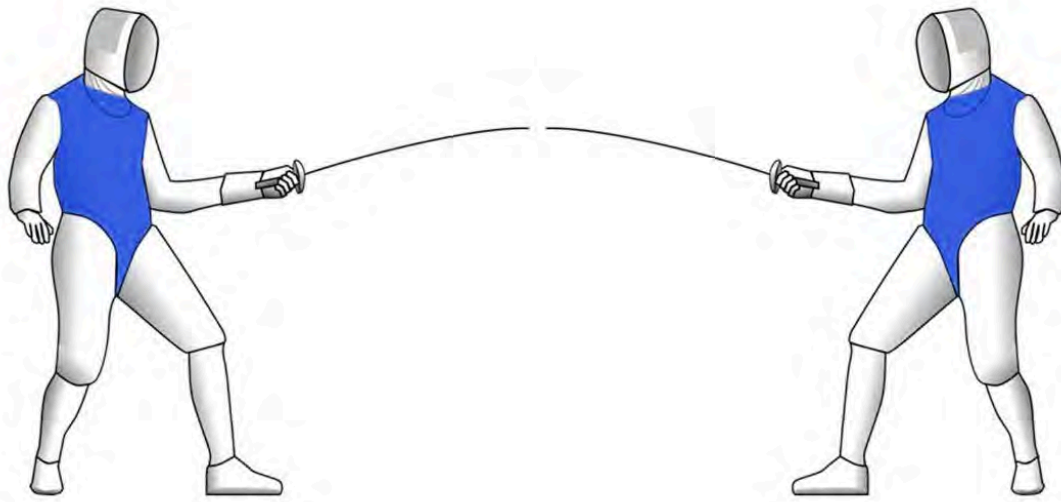

Figure 4 Valid target at foil

**t.91**

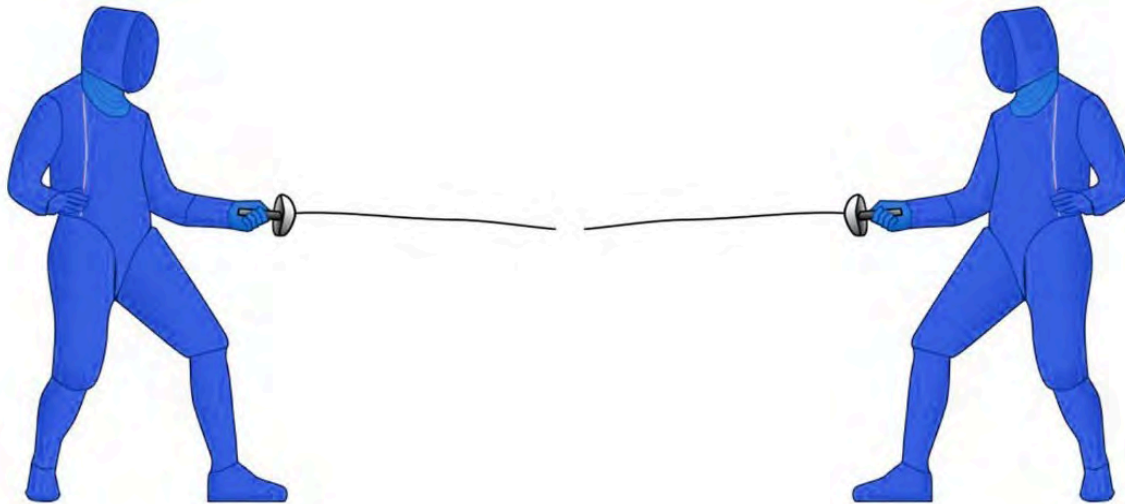

Figure 5 Valid target at épée

**t.98**

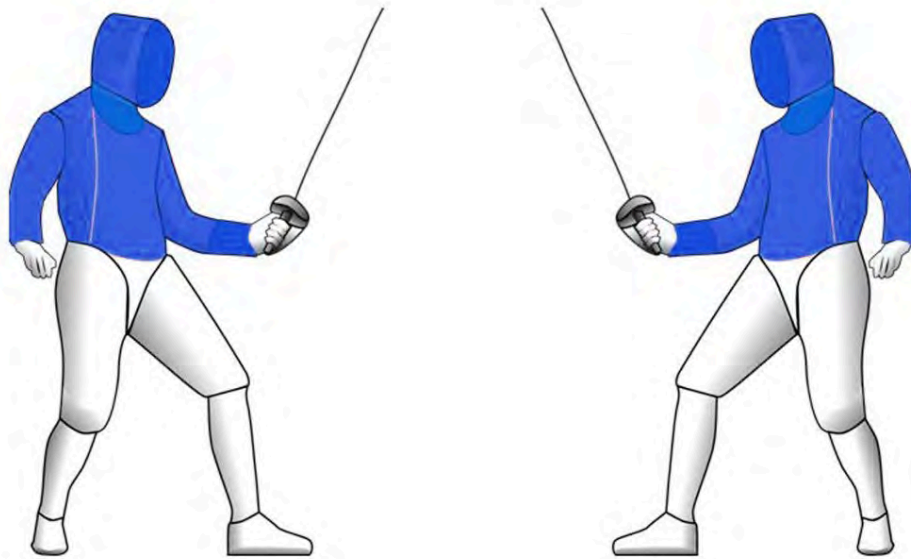

Figure 6 Valid target at sabre

**Refereeing Commission:** In favour.

**SEMI Commission:** In favour. Request additional drawings showing

- 1 Rear of targets for Foil and Sabre showing the hips
- 2 Details of the sabre glove
- 3 Bib on foil mask

**Rules Commission:** In favour.

**Opinion of the Executive Committee:** In favour of the proposal. The SEMI Commission's request should be considered as a future proposal to be dealt with by the Rules Commission.

**Article:** t.84

P.31

**Proposal from:** Refereeing Commission

**Motivation:** in foil, it should be no difference between movement forward with step or step with legs crossing one another and follow by lunge and counted as an attack if it is correct executed when the straightening of the arm precedes the end of the step forward (without or with the legs crossing one another).\*

However continuous steps forward constitute a preparation.

#### t.84

3 Continuous steps forward, ~~with the legs crossing one another~~, constitute a preparation and on this preparation any simple attack has priority.

\*This modification concerns English only.

**Refereeing Commission:** In favour.

**Coaches Council:** In favour.

**Athletes Commission:** In favour.

**Rules Commission:** Not in favour.

We can't modify a convention with a simple proposal, this is not the correct procedure, we propose to create a working group with members of the Coaches' Council, Athletes' Commission, Refereeing Commission and Rules Commission. As the FIE has in the past for sabre, the working group conducted tests during competitions.

**Opinion of the Executive Committee:** The Executive Committee agrees to establishing a working group. **The proposal must therefore be postponed.**

---

#### Article: t.97

P.32

**Proposal from:** Refereeing Commission

**Motivation:** Irrelevant as in sabre a hit on non-valid part of the target is not registered by the apparatus.

#### t.97

1 Only hits which arrive on the target are counted as valid.

The target comprises any part of the body above a horizontal line drawn between the top of the hip bones and then horizontally round the fencer's trunk (see Figure 6).

2 At sabre, it is forbidden to **protect** the target area or to **substitute** another part of the body for the target area, by covering it (cf. t.158-162, t.165, t.170); any hit scored by the fencer at fault is annulled.

a) If, during the fencing phrase, there is protection or substitution of a valid surface, the fencer at fault will be penalised as specified for offences of the 1st group (cf. also t.29).

~~b) If, during the fencing phrase, as a result of protection or substitution of a valid surface, a hit correctly given is registered as not valid, the fencer at fault will be penalized as specified for offences of the 1st group ( cf t.158 – 162, t.165, t.170) and the hit will be awarded.~~

**Refereeing Commission:** In favour.

**Rules Commission:** In favour.

**Opinion of the Executive Committee:** In favour of the proposal.



**Article: t.109****Proposal from: Women and Fencing Council****Motivation:**

- 1) To clarify the expectation on all participants in a competition to respect the FIE statutes and rules, including the Ethical Code and Safeguarding Policy.
- 2) To clarify the minimum reporting expectations if people witness a breach of the Ethical Code and Safeguarding Policy.

**t.109**

Everybody taking part in or present at a fencing competition **must respect the FIE statutes and rules, including but not limited to the FIE Ethical Code and Safeguarding Policy. They must remain orderly and must not disturb the smooth running of the competition.** During bouts no one is allowed to **go near the pistes, to give advice to the fencers, to criticise the Referee** or the judges, to insult them or to attempt to influence them in any way. Even the **team captain** must remain in the space assigned to him and he may only intervene in the situations and in the manner provided for in Article t.130 of the Rules. The Referee must stop immediately any activity which disturbs the smooth running of the bout which he is refereeing (cf. t.137.1–3). Any person who, for any reason, threatens or insults an official commits an offence of the 4th group and is penalised according to article t.169.

Any person present who witnesses a breach of the FIE Ethical Code and the Safeguarding Policy must report this to the Directoire Technique.

**Medical Commission:** Vote – 10/10 in **support** of proposal.

**PCM Commission:** In favour.

**Refereeing Commission:** Not in favour.

**SEMI Commission:** In favour with amendment

Any person present who witnesses a breach of the FIE Ethical Code and the Safeguarding Policy must report this to the Safeguarding Officer if present, or to the Directoire Technique.

**Coaches Council :** Not in favour.

Only referee can determine the rules breaking or any other infringements in the designated area of the bout and “ Referee must stop immediately any activity which disturbs the smooth running of the bout which he is refereeing”

Any other person present at the competitions who has problem with another person can follow the normal legal procedures.

**Athletes Commission:** In favour.

**Women and Fencing Council:** Agreed.

**Rules Commission:** Not in favour.

The matter is already covered by the FIE Ethical Code and the Safeguarding Policy.

**Veterans Council:** In favour.

**Fair Play Council:** In favour.

**Opinion of the Executive Committee:** In World Cups, the Supervisor is in charge of Safeguarding. Therefore, in favour of the proposal but with the following revised paragraph:

Any person present who witnesses a breach of the FIE Ethical Code or the Safeguarding Policy must report this to the Safeguarding Officer if present, or to the Supervisor or to the Directoire Technique.

P.34

**Article: t.111**

**Proposal from: Women and Fencing Council**

**Motivation:** To clarify that disturbing good order or smooth running can include failures to act in accordance with the FIE statutes, rules, Ethical Code and Safeguarding Policy.

**t.111**

The Referee and/or the Directoire Technique, on their own authority or at the request of an official delegate of the FIE or of the Organising Committee, can decide to expel from the competition venue, with or without a warning, any person who by his gestures, attitude, ~~or~~ language or failure to act in accordance with the FIE statutes, rules, Ethical Code and Safeguarding Policy, disturbs the good order or smooth running of the event.

**Medical Commission:** Vote – 10/10 in **support** of proposal.

**PCM Commission:** In favour.

**Refereeing Commission:** Not in favour.

**SEMI Commission:** In favour.

**Athletes Commission:** In favour.

**Rules Commission:** Not in favour. The matter concerns the Statutes.

**Fair Play Council:** In favour.

**Coaches Council:** Not in favour.

Only referee can determine the rules braking or any other infringements in the designated area of the bout and “ Referee must stop immediately any activity which disturbs the smooth running of the bout which he is refereeing”

Any other person present at the competitions who has problem with another person can follow the normal legal procedures.

**Women and Fencing Council:** Agreed.

**Veterans Council:** In favour.

**Opinion of the Executive Committee:** Referees and the Directoire technique cannot be required to and be responsible for interpreting the FIE Statutes or Ethical Code. In favour of the proposal amended as follows:

The Referee and/or the Directoire Technique, on their own authority or at the request of an official delegate of the FIE or of the Organising Committee, can decide to expel from the competition venue, with or without a warning, any person who by his/her gestures, attitude, or language [or by breaching the FIE Safeguarding Policy](#) disturbs the good order or smooth running of the event.

---

**Article:** [t.124](#) and [o.68](#)

P.35

**Proposal from:** Rules Commission

**Motivation:** To have an initial ranking in competitions to separate unranked fencers.

#### [t.124](#)

##### Unwillingness to fight (Non-combativity)

###### 1 Individual events – Direct elimination

- c) When, for the third time, there is one minute of unwillingness to fight, a P-black card is awarded as follows:
  - i) If the scores of the two fencers are equal, the Referee sanctions the fencer with the lower initial seeding in the competition, which is based on the FIE ranking [and by drawing lots among any fencers who are not in the ranking](#), with a P-Black card. The fencer with the higher initial seeding in the competition, which is based on the FIE ranking, wins the bout.

##### Composition of pools

#### [o.68](#)

- 1 The pools are composed taking account of [the initial seeding in the competition, which is based on](#) the latest official FIE ranking and by drawing lots among any fencers who are not in the ranking. The pools are composed using the following method:

**Refereeing Commission:** In favour.

**Coaches Council:** In favour.

**Athletes Commission:** In favour.

**Rules Commission:** In favour.

**Opinion of the Executive Committee:** In favour of the proposal.

**Article:** t.124

P.36

**Proposal from:** Refereeing Commission

**Motivation:** remove part of table of penalties t.170 from t.124, as for all other Articles in the rules book connected to t.170 are no copies of the table in the text and this part of the table in text is not identical to the part in question in table t.170.

**t.124**

There is unwillingness to fight when there is one minute of fencing without a hit or without a hit scored off the target.

In the event of **unwillingness to fight**, the Referee will immediately call 'Halt!' as a decision of "fact" (cf.t.136.2).

Unwillingness to fight is sanctioned as follows (t.170):

0.5	Unwillingness to fight: the sanctions imposed are shown by specific P-cards which are not cumulative with any other sanction awarded.	t.124	1 <sup>st</sup> time P-Yellow	2 <sup>nd</sup> time P-Red	3 <sup>rd</sup> time Penalisation
-----	---	-------	----------------------------------	-------------------------------	--------------------------------------

**Refereeing Commission:** In favour.

**Rules Commission:** In favour.

**Opinion of the Executive Committee:** In favour of the proposal.

**Article:** t.147

P.37

**Proposal from:** Rules Commission

**Motivation:** add missing references to t.147

**t.147**

Although a competitor may in fact have hit his opponent on the target, **this hit may be disallowed**, either because it did not arrive during the period of time during which fencing is allowed, or because the competitor had crossed the boundaries of the piste, or because of defects in the electrical equipment, or because violence was involved in the making of the hit, or because of other reasons as laid down in the Rules (cf. [t.25.2](#), [t.27.2](#), [t.28.2](#), [t.29](#), [t.33.2/4](#), [t.35.3](#), [t.44.2](#), [t.56.1](#), [t.73](#), [t.79](#), [t.80](#), [t.89.2](#), [t.93.1](#), [t.94](#), [t.95](#), [t.96.3](#), [t.97.2](#), [t.99.1-2](#), [t.101.5](#), [t.106](#), [t.121.2](#), [t.137.2](#), [t.161](#), [t.170](#)).

**Refereeing Commission:** Not in favour to add more and more article number references and remove all of them as below

#### **t.147**

Although a competitor may in fact have hit his opponent on the target, **this hit may be disallowed**, either because it did not arrive during the period of time during which fencing is allowed, or because the competitor had crossed the boundaries of the piste, or because of defects in the electrical equipment, or because violence was involved in the making of the hit, or because of other reasons as laid down in the Rules. (cf. [t.25.2](#), [t.27.2](#), [t.28.2](#), [t.29](#), [t.33.2/4](#), [t.35.3](#), [t.44.2](#), [t.56.1](#), [t.73](#), [t.79](#), [t.80](#), [t.89.2](#), [t.93.1](#), [t.94](#), [t.95](#), [t.96.3](#), [t.97.2](#), [t.99.1-2](#), [t.101.5](#), [t.106](#), [t.121.2](#), [t.137.2](#), [t.161](#), [t.170](#)).

**Rules Commission:** In favour, with the new correction.

Although a competitor may in fact have hit his opponent on the target, **this hit may be disallowed**, either because it did not arrive during the period of time during which fencing is allowed, or because the competitor had crossed the boundaries of the piste, or because of defects in the electrical equipment, or because violence was involved in the making of the hit, or because of other reasons as laid down in the Rules (cf. [t.25.2](#), [t.27.2](#), [t.28.2](#), [t.29](#), [t.33.2/4](#), [t.35.3](#), [t.44.2](#), [t.56.1](#), [t.73](#), [t.79](#), [t.80](#), [t.89.2](#), [t.93.1](#), [t.94](#), [t.95](#), [t.96.3](#), [t.97.2](#), [t.99.1-2](#), [t.101.5](#), [t.106](#), [t.121.2](#), [t.137.2](#), [t.161](#), [t.170](#)) according to the **Technical Rules**).

**Opinion of the Executive Committee:** In favour of the proposal as revised by the Rules Commission.

---

**Article:** [t.148](#)

**Proposal from:** Rules Commission

**Motivation:** add missing references to t.148

#### **t.148**

A competitor may have a hit awarded against him which he has not in fact received, either because he has crossed the rear limit of the piste (cf. t.34), or because he has committed an offence which has prevented his opponent fencing (a flèche attack which jostles the

opponent, the use of the unarmed hand while fencing, etc.) (cf. **t.22.9, t.137.2, t.162.1/2, t.165, t.166, t.167.1, t.170, t.79.1.b, t.97.2.b, t.124.**)

**Refereeing Commission:** Not in favour to add more and more articles number references and remove all of them as below

**t.148**

A competitor may have a hit awarded against him which he has not in fact received, either because he has crossed the rear limit of the piste (cf. t.34), or because he has committed an offence which has prevented his opponent fencing (a flèche attack which jostles the opponent, the use of the unarmed hand while fencing, etc.)

**Rules Commission:** In favour, with the modification

A competitor may have a hit awarded against him which he has not in fact received, either because he has crossed the rear limit of the piste (cf. t.34), or because he has committed an offence which has prevented his opponent fencing (a flèche attack which jostles the opponent, the use of the unarmed hand while fencing, etc.) (**cf. t.22.9, t.137.2, t.162.1/2, t.165, t.166, t.167.1, t.170, t.79.1.b, t.97.2.b, t.124.** according to the Technical Rules.

**Opinion of the Executive Committee:** In favour of the proposal as revised by the Rules Commission.

P.39

**Article:** **t.170.1.16**

**Proposal from:** Rules Commission

**Motivation:**

**Rationale:** t.56.10, touching during and after a fall, does not specify a yellow card sanction; however, intentionally falling to avoid the touch (\*) is sanctioned by a yellow card.

**t.170**

1.16	Irregular movements on the piste (*); hits made with violence <del>of</del> <del>during or after falling</del> (*) <del>Intentional fall to avoid the hit</del> (*)	t.121.2			
------	---	---------	--	--	--

**Refereeing Commission:** there is the same P.41 of Refereeing Commission.

**Rules Commission:** In favour.

**Opinion of the Executive Committee:** In favour of the proposal.

**Articles:** t.170. 1.1, 1.4, 1.12, 2.1, 2.5, 2.6, 3.1, 3.4, 4.1, 4.5, 4.6, 4.8.

P.40

**Proposal from:** Rules Commission

**Motivation:** add missing references to t.170

1st group		1st fault	2nd fault	3rd fault and following
1.1	Leaving piste without permission	t.23.6; t.120		
1.4	Covering/substitution of valid target (*)	t.29.2; t.30.1; t.79; t.97		
1.12	At sabre, hit made with the guard (*); any forward movement crossing the legs or feet (*)	t.96.3; t.101.5; t.121.2		

2nd group		1st fault	2nd fault	3rd fault and following
2.1	Use of non-sword arm/hand (*)	t.29.4; t.30		
2.5	Deliberate hit not on opponent (*)	t.55.3-2		
2.6	Dangerous, violent, or vindictive action, blow with guard or pommel (*)	t.121.2; t.26.1; t.147; t.149.1		

3rd group		1st time	2nd time
3.1	Fencer disturbing order when on the piste. In the most serious cases, the Referee may award a black card (t.168) immediately.	t.108.2; t.109; t.110; t.137.2; t.139.3	
3.4	Any person not on the pist disturbing good order. In the most serious cases, the Referee may award a black card immediately (t.168).	t.109; t.110; t.111; t.130; t.132.2; t.133;	

	t.137.3/4; t.152; t.162.4; t.168		
--	-------------------------------------	--	--

4th group		PENALTIES (Cards)	
4.1	Fencer equipped with electronic communication equipment permitting him to receive communications during bout.	t. 64.6; t.68; t.73.1.g	
4.5	Offence against sportsmanship.	t.121.2; t.122; t.123; t.129; t.144.2; t.149.1	
4.6	Refusal of a fencer to salute his opponent, the referee and the spectators before the beginning of the bout or after the last hit.	t.122; t.145.2	
4.8	<del>Deliberate</del> Intentional * brutality	t.26.1; t.149.1	

\*This modification concerns English version only.

**Refereeing Commission:** Not in favour with all references marked in yellow as they are not correct and add in 4.8 a text as in the rules book t.149.1

1st group		1st fault	2nd fault	3rd fault and following
1.1	Leaving piste without permission	t.23.6; t.120		
1.4	Covering/substitution of valid target (*)	t.29.2; t.30.1; t.79; t.97		
1.12	At sabre, hit made with the guard (*); any forward movement crossing the legs or feet (*)	t.96.3; t.101.5; t.121.2		

2nd group		1st fault	2nd fault	3rd fault and following
2.1	Use of non-sword arm/hand (*)	t.29.1; t.30		
2.5	Deliberate hit not on opponent (*)	t.55.3-2		
2.6	Dangerous, violent, or vindictive action, blow with guard or pommel (*)	t.121.2; t.26.1; t.147; t.149.1		



3rd group		1st time	2nd time
3.1	Fencer disturbing order when on the piste. In the most serious cases, the Referee may award a black card ( <del>t.168</del> ) immediately.	t.108.2; <del>t.109;</del> <del>t.110;</del> t.137.2; <del>t.139.3</del>	
3.4	Any person not on the piste disturbing good order. In the most serious cases, the Referee may award a black card immediately ( <del>t.168</del> )	t.109; t.110; t.111; <del>t.130;</del> <del>t.132.2;</del> t.133; t.137.3/4; <del>t.152;</del> <del>t.162.4;</del> t.168	

4th group		PENALTIES (Cards)	
4.1	Fencer equipped with electronic communication equipment permitting him to receive communications during bout.	t. 64.6; <del>t.68;</del> t.73.1.g	
4.5	Offence against sportsmanship.	t.121.2; t.122; t.123; <del>t.129;</del> <del>t.144.2;</del> t.149.1	
4.6	Refusal of a fencer to salute his opponent, the referee and the spectators before the beginning of the bout or after the last hit.	t.122; <del>t.145.2</del>	
4.8	<del>Deliberate Intentional * brutality</del> <b>Violent or vindictive actions</b>	<del>t.26.1;</del> t.149.1	

**Rules Commission:** In favour, with the modifications:

1st group		1st fault	2nd fault	3rd fault and following
1.1	Leaving piste without permission	t.23.6; t.120		
1.4	Covering/substitution of valid target (*)	t.29.2; t.30.1; t.79; t.97		
1.12	At sabre, hit made with the guard (*); any forward movement crossing the legs or feet (*)	t.96.3; t.101.5; <del>t.121.2</del>		

2nd group		1st fault	2nd fault	3rd fault and following
2.1	Use of non-sword arm/hand (*)	t.29.4; t.30		

2.5	Deliberate hit not on opponent (*)	t.55.3-2			
2.6	Dangerous, violent, or vindictive action, blow with guard or pommel (*)	t.121.2; t.26.1; t.147; t.149.1			

3rd group		1st time	2nd time
3.1	Fencer disturbing order when on the piste. In the most serious cases, the Referee may award a black card (t.168) immediately.	t.108.2; t.109; t.110; t.137.2; t.139.3	
3.4	Any person not on the pist disturbing good order. In the most serious cases, the Referee may award a black card immediately (t.168).	t.109; t.110; t.111; t.130; t.132.2; t.133; t.137.3/4; t.152; t.162.4; t.168	

4th group		PENALTIES (Cards)		
4.1	Fencer equipped with electronic communication equipment permitting him to receive communications during bout.	t. 64.6; t.68; t.73.1.g		
4.5	Offence against sportsmanship.	t.121.2; t.122; t.123; t.129; t.144.2; t.149.1		
4.6	Refusal of a fencer to salute his opponent, the referee and the spectators before the beginning of the bout or after the last hit.	t.122; t.145.2		
4.8	<del>Deliberate</del> Intentional * brutality	t.26.1; t.149.1		

\*This modification concerns English version only.

**Opinion of the Executive Committee:** In favour of the revised proposals from the Rules and Refereeing Commissions, summarized as follows:

1st group		1st offence	2nd offence	3rd offence and subseq.
1.4	Covering/substitution of valid target *	t.29.2, t.30.1, t.79, t.97	YELLOW	RED

2nd group		1st offence	2nd offence	3rd offence and subseq.
2.4	Intentionally dropping a weapon during the fencing phrase	t.56.11	RED	RED
2.5	Deliberate hit not on opponent *	t.55.3-2		
2.6	Dangerous, violent or vindictive action, blow with guard or pommel *	t.26.1, t.121.2, t.147, t.149.1		

	OFFENCE	ARTICLES	PENALTIES (Cards)	
			1st time	2nd time
<b>3rd group</b>				
3.1	Fencer disturbing order when on piste. In the most serious cases, the Referee may award a black card immediately ( <del>t.168</del> )	t.108.2, <del>t.109, t.110,</del> t.137.2, (t.168)	RED	BLACK

	OFFENCE	ARTICLES	PENALTIES (Cards)	
			1st time	2nd time
<b>4th group</b>				
4.1	Fencer equipped with electronic communication equipment permitting him to receive communications during bout	t.64.6, <del>t.68</del> , t.73.1.g		BLACK
4.8	<del>Deliberate brutality</del> Violent or vindictive actions	t.149.1		

**Article:** t.170.0.5, 1.16 and 2.6

P.41

**Proposal from:** Refereeing Commission

**Motivation:** modification of t.170 in accordance with text of Technical rules book

a) proposal to modify as below

0.5	Unwillingness to fight: the sanctions imposed are shown by specific P-cards which are not cumulative with any other sanction awarded.	t.124	1 <sup>st</sup> time P- Yellow	2 <sup>nd</sup> time P-Red	3 <sup>rd</sup> time Penalisatio n-P-Black
-----	---	-------	--------------------------------------	-------------------------------	--

Add text to 1.16 according to modification after Congress 2022 of t.121.2

1.16	Irregular movements on the piste (*); hits made with violence <del>or during or after falling</del> (*) Intentional fall to avoid the hit (*)	t.121.2			
------	---	---------	--	--	--

b) Remove article number t.149.1 from 2.6 as a penalty according to this article means "exclusion" and not fit to the red card penalties of the second group

	OFFENCE	ARTICLES	PENALTIES (Cards)		
			1st offence	2nd offence	3rd offence and subseq.
<b>2nd group</b>					
2.1	Use of non-sword arm/hand *	t.29.1, t.30	RED	RED	RED
2.2	Demanding a break for medical reason deemed unjustified By doctor	t.45.3			
2.3	Absence of weapon control marks *	t.73.1a			

2.4					
2.5	Deliberate hit not on opponent *	t.55.3			
2.6	Dangerous, violent or vindictive action, blow with guard or pommel *	t.121.2, t.147, t.149.4			

**Refereeing Commission:** In favour.

**Rules Commission:** In favour.

**Opinion of the Executive Committee:** In favour and for 0.5 add t.124.1 and t.124.2 in the column of articles.

P. 42

**Article:** t.170. 3.4

**Proposal from:** Rules Commission

**Motivation:** Add to t.170 sanctions of the 3rd group, article t.110: smoking in competition halls. This practice is becoming more and more frequent with the appearance of electronic cigarettes.

3.4

3rd group		1st time	2nd time
Any person not on piste disturbing the good order. <b>Smoking in the competition halls.</b> In the most serious cases, the Referee may award a black card immediately (t.168).	t.109; t.110; t.111; t.130; t.132.2; t.133; t.137.3/4; t.152; t.162.4; t.168		

**Refereeing Commission:** In favour for additional text, references numbers as in P.40 and for the first time “yellow card”

3rd group		1st time	2nd time
3.4	Any person not on piste disturbing the good order. <b>Smoking in the competition halls</b> . In the most serious cases, the Referee may award a black card immediately <del>(t.168)</del> .	t.109; t.110; t.111; <del>t.130</del> ; <del>t.132.2</del> ; t.133; t.137.3/4; <del>t.152</del> ; <del>t.162.4</del> ; t.168	

**Rules Commission:** In favour, with the proposed modification:

3rd group		1st time	2nd time
3.4	Any person not on piste disturbing the good order, <b>including smoking in the competition halls including electronic cigarettes</b> . In the most serious cases, the Referee may award a black card immediately <del>(t.168)</del> .	t.109; t.110; t.111; <del>t.130</del> ; <del>t.132.2</del> ; t.133; t.137.3/4; <del>t.152</del> ; <del>t.162.4</del> ; t.168	

**Opinion of the Executive Committee:** In favour of the revised proposal:

	OFFENCE	ARTICLES	PENALTIES (Cards)	
			1st time	2nd time
	<b>3rd group</b>			
3.4	Any person not on piste disturbing good order ; <b>smoking in the competition halls (including with electronic cigarettes)</b> . In the most serious cases, the Referee may award a black card immediately <del>(t.168)</del> .	t.109, t.110, t.111, <del>t.132.2</del> , t.133, t.137.3/4, t.168	YELLOW	BLACK

P.43

**Article:** t.170. 3.6

**Proposal from:** Rules Commission

**Motivation:** In accordance with Article t.121.2, a (\*) must be added to t.170 to indicate the cancellation of the hit scored.

3rd group		1st time	2nd time
3.6	Anti-sporting behaviour (*)	t. 121.2	

**Rules Commission:** In favour.

**Opinion of the Executive Committee:** In favour of the proposal.

	OFFENCE	ARTICLES	PENALTIES (Cards)	
			1st time	2nd time
3.6	Anti-sporting behaviour *	t.121.2	RED	BLACK

**Article:** Index to articles

P.44

**Proposal from:** Rules Commission

**Motivation:** -

**INDEX TO ARTICLES (TECHNICAL RULES)**

Abandon: see «Withdrawal»: [t.120](#)  
Abnormal movement: [t.29.2](#)  
**Abnormal:** [t.56.8](#), [t.79.1.c](#)  
Absence of check marks on material: [t.73.1.a](#), [t.170](#)  
Absence of name on back: [t.74](#), [t.170](#)  
Accident: [t.20.3](#), [t.116](#)  
Accidental cause: [t.36](#), [t.57](#), [t.73.1.e](#)  
Accompany: [t.137.3](#)  
Action: [t.8ss](#), [t.21](#), [t.23.3](#), [t.27.1](#), [t.28.2](#), [t.29.1](#), [t.33](#), [t.55.1](#), [t.61.3](#), [t.62](#), [t.76](#), [t.83](#), [t.86](#), [t.93](#), [t.121.2](#), [t.130](#)  
Action (simultaneous): [t.89](#), [t.106](#)  
Action (vindictive, violent): [t.149.1](#)  
Active season: [t.47](#), [50.3](#), [t.159](#), [t.162.3](#), [t.167.2](#), [t.169](#), [t.170](#)  
~~Advance (shoulder of non-sword arm): [t.80.2](#)~~  
**Additional minute:** [t.22.8](#)  
Advice (giving): [t.45.4](#), [t.109](#)  
A Grade competitions: see «World Cup»  
Analysis of the fencing phrase: [t.58](#), [t.59.1](#), [t.61.3](#)  
Announcement (penalties): [t.139.4](#), [t.157](#)  
Annulment of hit: see «Hits (annulment) »  
Anti-sporting behavior: see «Sportsmanship»: [t.121.2](#), [t.170](#)  
Apparatus (electrical): [t.39.3](#), [t.44](#), [t.47.2](#), [t.48.1](#), [t.53](#), [t.55.2](#), [t.58](#), [t.68.3](#), [t.73.1.f](#), [t.80](#), ~~t.84~~, [t.92](#), [t.94](#), [t.95.2](#), [t.99](#), [t.170](#)  
Apparatus (audible): see «Audible signal»  
Appeals (against a decision): [t.136](#), [t.138](#), ~~t.139~~-[t.141](#), [t.143](#), [t.170](#), [t.172](#)-[t.175](#)  
Appeals (against composition of first round)  
Appeals (unjustified): [t.45.3](#), [t.174](#),  
Appeals (Video Refereeing): [t.60](#)-[t.62](#)  
Arm (extending, straight): [t.9.1](#), [t.15](#), [t.83.2](#), [t.101](#), [t.103](#)  
Arm (non-sword): [t.21.4](#), [t.27.1](#), [t.29](#), [t.30](#), [t.48.1](#), [t.115](#), [t.148](#), [t.170](#)  
Arm (withdraw): [t.13](#), [t.89.5.f](#), [t.106.4.f](#)  
Assembly area: [t.65.2](#)  
~~Assault: [t.2](#)~~  
Attachment (on handle): [t.21](#)  
Attack: [t.9](#), [t.10](#), [t.12-14](#) ~~13~~, [t.25.3](#), [t.26](#), [t.28.3](#), [t.32](#), [t.35.1](#), [t.83-89](#), [t.90.1](#), [t.101-106](#), [t.121.2](#), ~~t.146~~, [t.148](#)  
Audible signal: [t.44.1](#)  
Avoid a hit: [t.13.2](#), [t.25.2](#), [t.35.3](#), [t.83.1](#), [t.101.1](#), [t.106.3.b](#), [t.121.2](#), [t.170](#)

Awarding of hit not recorded: [t.41.1](#), t.54, t.79, [t.124](#), t.137.2, t.144, t.148, .170  
 Back: [t.21.2](#), [t.29.3](#), t.30.3, t.35.1, t.74.1, t.75.1, t.77.1, t.95.1,  
 Back foot: t.22.8,  
 Back of blade: t.96, t.105.2  
 Bend: t.83.2.b, t.106.4.d  
 Bend of blade: see «Curve in blade»  
 Bib: t.77.2  
 Black Card: [t.20.2](#), [t.124](#), t.159, t.160, t.162, t.163, t.167-169, t.170  
 Blade: t.11, t.21.3, t.68.1, t.72, ~~t.95.2~~, [t.94.1](#), [t.96](#), t.103, [t.105](#), [t.170](#)  
 Blade (areas of insulation): t.68.1, ~~t.95.2~~,  
 Blade (broken): t.56.6 7  
 Blade ('foible' and 'forte'): t.85, t.104  
 Blade (contact): [t.13.1](#), t.84-87, t.89, t.94.3, t.104, t.106.3.e  
 Blade (mere contact of): t.84, t.89.5, t.102, t.106.4 3.2  
 Blocking the scoring apparatus: t.39  
 Bodywire: t.66, t.71-73, t.95.1, t.117, t.126, t.170  
~~Bout: t.3/4~~  
 Bout (beginning, stopping, restarting): [t.21](#), t.22.1, [t.22.4](#), [t.25](#), [t.28](#), [t.58](#), [t.80](#), [t.90](#), [t.99](#), t.23, t.32-33  
 Bout (score-sheet): t.38.2, t.40.4, [t.45.1](#), [t.50.7](#), [t.124.3.e](#), t.163, t.168  
 Bout (duration): see «End of bout»  
 Bout (end): see «End of bout», «Number of hits»  
 Bout (number of hits): see «End of bout», «Number of hits»  
 Broken blade: ~~t.56.6~~-[t.56.7](#)  
 Brutality: t.25.3, t.26, t.170  
 Bureau of the FIE (Central Office of the FIE): t.135. [t.139.4](#), [t.143.4](#), [t.157](#), [t.176](#)  
 Cadets: ~~t.74.2~~ [t.61.4](#)  
 Calling (fencers — initial, onto piste): t.22, [t.47](#), t.118, t.119, t.170  
 Card (Yellow, Red, Black): see «Penalties», «Yellow Card», «Red Card», «Black Card» Category A  
 Competitions: see «World Cup»  
 Casting doubt:[t.170](#), [t.172](#)  
 Censure: t.139.4, t.144.2, t.154, t.178,  
~~Central Office of the FIE: see Bureau: t.139.4, t.143, t.157, t.175.2~~  
 Championship: ~~t.1, t.6~~, t.66, t.73.2, ~~t.74.2~~, t.159, t.167, t.169, t.170  
 Change (of ends – referee – judges): t.30.3, t.48.4, t.50.4  
 Change (of hand, weapon, equipment): t.21.4, t.56.2, [t.66.1](#), [t.68.1](#), [t.80](#), t.81.1, t.99.1, t.126  
 Checking (equipment): t.47.2, t.56.89, t.64, t.65, t.66-70, t.73, t.114, t.137  
 Checking zone: t.66.1; see also assembly area  
 Chin: t.77  
 Classification: t.128, t.149  
 Clock: t.44,  
 Close quarters: t.24  
 Clothing: t.20.2, t.64, t.68.1, t.71, t.74, [t.74.2](#), t.91, t.115, ~~t.126~~, t.170  
 Collision: t.121  
 Collusion: t.128, t.149, t.170  
~~Coming on guard: t.22, t.31~~  
 Commands (Referee): t.22.11, t.63, [t.80](#), ~~t.81.4~~, see «Referee (signals and commands) »  
~~Communication equipment (electronic): t.64.6, t.68.1, t.73.1.g, t.170~~  
~~Competitions: t.1-6~~  
~~Competitions (A Grade): see «World Cup»~~  
 Compound (actions): t.10, t.11.3, t.13, t.83.2.b, t.87-89, t.101.3/4, t.103, t.106  
 Conductive piste: [t.18.3](#), t.47.2.k, [t.94.1](#), t.95.32, t.170  
 Confiscating defective equipment: t.70, t.73.1  
 Confused fencing: t.23.5, t.58,  
~~Contact, electrical: t.170~~  
 Contact (blade): t.13.1, t.22.4, t.84.21, t.89.5, t.102.1, t.105.2, t.106.4  
 Contact (body): t.25, t.26  
 Counter-time: [t.13.4](#)  
 Control by Referee: t.37  
 Control (fencers' equipment): t.20.3, ~~t.170~~, see also «Checking (equipment)»  
 Conventions (foil): t.76, t.82-89

Conventions (épée): t.90-95  
 Conventions (sabre): t.96-106  
 Correct attack: t.83, t.85, t.101, t.102, 104  
 Corps à corps: t.25, t.26, t.32, t.170  
 Counter-attack: t.12,  
 Counter-riposte: t.9  
 Counter-time: t.13.4  
 Coup double: t.92, t.106.2  
 Coupé: see «Cutover»  
 Court of arbitration for sport: t.135  
 Courtesy: t.108,t.121.2, t.173  
 Covering the valid target: t.29.2, t.30.1, t.71, t.170; see also «Surface»  
 Criticizing referees/judges: t.109  
 Crossing legs (sabre): t.101.5, t.170  
 Crossing limits of piste: t.18, t.22.9, t.26.2, t.33-36, ~~t.146-8~~, t.147-8, t.170  
 Curve in blade: t.72, t.170  
 Cutting edge (hit with the): t.96, t.101.2, t.103.1, t.105  
 Cutover: t.11.2, t.83, t.102  
 Cuts: t.96.2, t.105.2  
 Dangerous fencing: t.23.5, t.75.2, t.123, t.170  
 Decision (referee, DT): t.50.4, t.56.23, t.59.2, t.61.3, t.62, t.73.3, t.111, t.122, t.138, t.140-141, t.143  
 Decision (regarding point of fact): t.112, t.124, t.136, t.137.2, t.170  
 Decision (attempt to influence): t.125, t.130, t.133, t.172-75, ~~t.177~~  
 Defective equipment: t.70. t.72  
 Defence (right of): t.176  
~~Defend personal chance: see «Utmost ability (fence to)»~~  
 Defensive actions: t.9.2, t.12, t.14, t.21, t.29; see also «Parry»  
 Defensive/offensive actions: t.12, t.83.2  
 Delayed (riposte): t.11, t.13, t.106.3.c  
 Delegates — SEMI: see «SEMI (Committee)»: t.66.1, t.73, t.56, ~~t.95~~  
 Delegates — FIE Medical Committee: t.45  
 Delegates — FIE Refereeing Committee: t.50,t.51, t.52, t.111, t.130, t.135, t.138-141, t.143.2, t.174-175  
 Deliberate: t.55.2, t.170  
 Dérobement: t.84.32, t.89.5.b, t.102.2, t.106.4.b  
 Device (safety): see «Safety device»  
 Direct (attack — riposte): t.10, t.78, t.83.2, ~~t.84.1~~, t.89.4.c, t.102.3, t.106.3  
 Direct parry: t.14,  
 Direct riposte: t.11, t.86, t.105.1,  
 Direct elimination: t.22.8, t.39, t.42, t.48.4, t.50, t.61.1, t.64, t.65.2, t. 66.1, ~~t.74.2~~, t.114, t.118, t.124.1, t.131.1, t.170  
 Direction of the bout: t.47, t.137  
 Directoire Technique: t.20.2, t.30.1, t.45.5, t.46, t.50.3, t.111, t.127, t.129, t.135, t.137, t.139-141, t.143, t.157, t.164, t.168, t.169.2, t.175, t.177  
 Disarming: t.23.5  
 Disciplinary authorities: t.108.2, t.134, t.135  
 Disciplinary procedure: t.171ss  
 Disciplinary Code of the FIE: ~~t.135~~, t.134, t.143, t.145.2, t.169.2, t.178.2  
 Disciplinary Commission: t.135, t.140, t.143  
 Discipline: t.108, t.129, ~~t.135~~, t.134, t.139, t.144.2, t.170, t.178  
 Disciplinary Rules: t.135  
 Disciplinary Commission: 142, t.143  
 Disengagement: t.11.2, t.83, t.102.3  
 Dishonest: t.121.1, t.170  
 Disorderly fencing: t.121, t.170  
 Displacing target: t.13.2, t.27; see also «Extension (of the valid surface)»  
~~Cramp: t.45, t.170~~  
 Disqualification: t.137.4, t.144, t.153, t.178  
 Disturbing good order: t.109, t.111, t.133, t.144.2, t.162.4, t.168, t.170, t.178  
 Distance (on-guard): t.22, t.31, ~~t.124~~  
 Doctor: t.45, t.116, t.170



Doping: t.170,  
 Double hit: t.33.4, t.38, t.89.3/6, t.92, t.94.5, t.106  
 Doubtful (hit): t.56.5, t.57, t.94.5  
 Dragging point on conductive piste: t.76.2, t.90.2, t.170  
 Drawing lots: t.38, t.40, t.41, t.50.1,5/6  
 Dressing (forbidden on the piste): t.116, t.170  
 Ducking: t.27.1  
 Duration of bout: t.37-42; see also «End of bout»  
 Electronic communication equipment: t.64.6, t.68.1, t.73.1.g, t.170  
~~Elimination: t.48.4, t.39, t.42, t.50, t.61.1, t.64, t.65.2, t.66.1, t.74.2, t.114, t.118, t.124.1, t.131.1, t.170~~  
 Enclosure: see «Piste enclosure»  
 End of bout: t.21.4, t.44.4, t.62.3, t.127, t.128  
 End of time (period- - minute): t.38.2, t.39.3, t.40.3, t.41.5, t.44.4, t.45.1, t.124.3.f  
 Epée: t.21.3, t.68.3, t.90, t.91, t.95.2, t.170  
 Equal scores: t.38.2, t.40.3, t.41.5, t.62.3, t.124  
 Equipment (of fencers): t.20, t.29.3, t.47.2, t.56, t.64, t.66.1, t.69, t.80, t.81, t.91, t.94, t.99.1, t.114, t.123  
 Equipment (failure): see «Failure»  
 Equipment (non-regulation): t.70, t.72, t.73.1.g, t.147, t.170  
 Etiquette (fencing): t.121  
 Exclusion (fencer): t.137.4, t.144, t.149, t.150, t.153.3, t.159, t.162.3, t.167.2, t.169, t.170, t.178.2  
 Executive Committee: t.135, t.142, t.143  
 Experts (electrical equipment): t.47.2.j, t.56.7/8/9, t.66.1, t.70, t.73  
 Expiry of time: t.39, t.41, t.42, t.44; see also «End of bout»  
 Expulsion: t.137.3, t.144.2, t.152, t.162.4, t.170  
 Extension (of the valid surface): t.79  
 Extension (of the penalty): t.139.4  
 Failure (of clock): t.44.3  
 Failure (of electrical material): t.56.5, t.94.5  
 Failure (to appear on time): t.150.1  
 Faithfully: t.108, t.121.1, t.170  
 Falling, hit made while: t.121.2, t.170  
 Favouring an opponent: t.128, t.170  
 Feint: t.83, t.87, t.89, t.101, t.103  
 Fencers (obligations of): t.20, t.107, t.108, t.112  
 Fencing: t. 21ss  
 Fencing (beginning, stopping, restarting): t.23  
 Fencing (close quarters): t.24  
~~Fencing (confused): t.23.5, t.58~~  
 Fencing (dangerous/violent): t.23.5, t.75.2, t.121.2, t.123, t.149.1, t.170  
 Fencing etiquette: t.109, t.112, t.121  
 Fencing (incorrect/unsporting):, t.121.2, t.170  
 Fencing (respect of phrase): t.59.1, t.79, t.83, t.84, t.89, t.98, t.100, t.101- t.106, t.170  
 Fencing (time): t.8, t.12.3, t.22.8, t.38.2, t.40-44, t.88, t.89.4/5f, t.103.32, t.106.4  
 FIE Supervisor: t.20, t.45.1, t.135, t.138-141, t.143.2, t.169.2, t.174  
 FIE Central Office: 142, t.143  
 Field of play: t.16-19; see also «Piste»  
 Finals (referees, judges): t.48.2, t.50.5/6, t.52  
 Finals (time-keeper): t.37.2, t.44.42,  
 Finals (presentation of fencers for equipment checking): t.64, t.65.2, t.66.1,  
 Fine: t.144  
 Flèche: t.9, t.25, t.26, t.28.3, t.32, t.35.3, t.83.2, t.121.2, t.148, t.170  
 Flexibility (blade): t.21.3, t.105.2.b  
 Foil: t.21.3, t.22.2, t.22.12, t.24, t.33.4, t.64.2, t.68.1, t.76, t.77, t.79.1, t.82, t.89, t.170  
 Follow the phrase: t.13, t.23, t.24, t.47.2.f, t.106.4.f  
 Forbidden: t.76.2, t.96  
 Forbidden (changing hand during the bout): t.21.4  
 Forbidden (flèche and forward movement crossing legs at sabre): t.101.5, t.170  
 Forbidden (give advice): t.109  
 Forbidden (hindering tests to detect a fault in the equipment): t.47.2.d  
 Forbidden (blow with guard): t.96.3, t.170

Forbidden (irregular actions): t.121.2, t.170  
 Forbidden (leave the piste without permission): t.23.6, t.170  
~~Forbidden (place non-insulated part of weapon on conductive jacket at foil): t.170~~  
 Forbidden (protection or substitution of valid target at foil and sabre): t.30, t.79, t.97.2, t.170  
 Forbidden (pushing or letting drag the point): t.76.2, t.90.2, t.170  
 Forbidden (cause corps à corps) : t.25.2  
 Forbidden (smoking in competition halls): t.110, t.170  
 Forbidden (straightening weapon on piste): t.76.2, t.90.2, t.96.5, t.170  
 Forbidden (turning back on opponent): t.27.2, t.170  
 Forbidden (undressing on the piste): t.116, t.170  
 Forbidden (use of non-sword hand and arm): t.29, t.30, t.48, t.170  
 Fortuitous circumstances: t.94.3,  
 Functions of the Referee: see «Referee»  
~~Glossary: t.2ss~~  
 Glove: t.20.2, t.115.1  
 Ground gained/lost: t.31, t.35, t.144.1, ~~t.146~~  
 Ground judges: see «Judges»  
 Guard (hitting with): t.96.3, t.121.2, t.170  
 Hair: t.115, t.170  
 Halt: t.23, t.26, t.28, t.31, t.33, t.37, t.44.2, t.55, t.76.2, t.90.2, t.124, t.125, t.170  
 Hand (injured/holding weapon/unarmed): t.21, t.22, t.27, t.29, t.48, t.115, t.148, t.170  
 Hand (judges): see «Judges»  
 Hand (non-sword): t.29, t.30, t.48, t.170; see «Use of non-sword hand/arm»  
 Handle: t.21, t.99.2  
 Hindering tests to detect faults: t.47.2.d  
 Hits (annulment): t.23, t.25.2, t.27.2, t.28.2, t.29, t.33.2, t.43.3, t.56, t.57, t.73, t.79, ~~t.55ss~~, t.80, t.81.1, t.89.2, t.93, t.94, t.95, t.96.3, t.97.2, t.99, t.101.5, t.106.1, t.121.2, t.147, t.161, t.170  
 Hits (before 'Play!'): t.55.1  
 Hits (brutal): t.26.1, t.121.2, t.170  
 Hits (after crossing the boundaries of the piste): t.22.9, t.26.2, t.28.3, t.33, t.34, t.35, t.94.5, t.147  
 Hits (after 'Halt!'): t.23.3, t.55.1  
 Hits (at the end of a bout): t.38-42  
 Hits (double): t.33.4, t.38.1, t.89, t.92, t.94, t.106  
 Hits (doubtful): t.56-7, t.57, t.72, t.81, t.94.4, t.95, t.99  
 Hits (judging): t.28, t.33, t.46, t.48.1, t.53, t.54.2, t.59.2, t.81-2, t.84, t.89, ~~t.90, t.92~~, t.93, t.94, t.96, t.98, t.99, t.102, t.106, t.137.1/2,  
 Hits (method of making): t.9-13, t.28.2, t.76, t.90, t.96, t.97, t.98-4, t.106-4.f,  
 Hits (not valid): t.44.4, t.78, t.79.1.b, t.94.5, t.97.2.b, t.98  
 Hits (other than on opponent): t.48.1, t.55, t.78, t.93, t.94, t.170  
 Hits (penalty): t.41, t.79, t.124, t.162, t.163, t.165, t.167, t.170; see also «Refusal (to award a hit)»  
 Hits (passing the opponent): t.28.2  
 Hits (seeking, giving away, offering): t.128, t.170  
 Hits (simultaneous): t.89, t.106  
 Hits (stop hits): see «Stop hit»  
 Hits (through the blade): t.96.4  
 Hits (thrusting with the point): t.76.1, t.84.1, t.89.4, t.90.1, t.96.1  
 Hits (with the back of the blade): t.96.2, t.105.2  
 Hits (with the cutting edge): t.96-2, t.105.2  
 Hits (with the guard): t.96.3, t.121.2, t.170  
 Immediate (hit): t.11, t.13, t.33.2, t.28.2, t.85.2, t.86, t.89.5.f, t.104.2, t.105.1, t.106.4.c/f  
 Impartiality (referees and judges): t.46.1  
 Indirect (attack, riposte): t.10, t.11.2, t.13, t.83.2.a, t.86, t.105  
 Individual competition: t.48.2, t.50, t.60, t.61, t.113, t.118, t.119, t.124.1/3, t.131, t.170, t.173  
 In line: see «Point in line»  
 Incorrect (fencing): t.121, t.170  
 Influence decisions, referees and judges (attempt to): t.109, t.133  
 Injury: t.21.4, t.45, t.170  
 Insult (referee, judge): t.109 ~~t.444~~  
 Integrity: t.108, t.121  
 Intentional: t.25.2, t.26.1, t.55.2, t.121.2, t.170

International Olympic Committee: see also «IOC»  
 Interruption of a bout: t.22, t.43, t.115.2, t.170  
 Intervention of Directoire Technique: t.139, t.164  
 Investigation: t.176  
 IOC: t.135, t.142, t.157  
 Irregular movements: t.121.2, t.170; see also «Violent fencing»  
 Irregularities in equipment (deliberate): t.70, t.72, t.73, t.170  
 Jacket (conductive): t.64.1/4, t.71, t.72-5, t.73.1.g, t.75.1, t.170  
 Jacket (fencing): t.64, t.74, t.75, t.115, t.170  
~~Jamming the apparatus:~~  
 Jostling: t.25, t.26, t.36, t.121.2, t.148, t.170  
 Judges: t.30, t.46.1, t.47.2.e, t.48, t.54.1, t.79.2, t.109, t.112  
 Judging (hits): t.53-t.59, t.83-2, t.84- t.89, t.93-t.95, t.99, t.102, t.105.2, t.106  
 Junior: t.50.3, t.61.4, t.159, t.167.2, t.169, t.170  
 Juridical Authorities: t.158  
 Jurisdiction (principle of): t.136, t.137.3, t.139  
 Label of safety/guarantee: t.64.1, t.68.1  
 Lamps: t.44.4, t.47.2.f, t.54.2, t.80  
 Leaving piste: t.23.6, t.26.2, t.33-3/4, t.35.1, t.36, t.78, t.94.5, t.98, t.120, t.123, t.146, t.147, t.170, t.172; see also «Crossing limits of piste»  
 Left-hander: t.22-1  
 Length of piste: t.18; see also «Piste»  
 Licence, international: t.49, t.143.4  
 Licence, refereeing: t.47, t.49.1  
 Limits of piste: t.18, t.19.3, t.28.3, t.33, t.34, t.35, t.148 ;see «Piste», «Crossing limits of piste», «Lines on piste»  
 Line: see «Point in line»  
 Lines on piste: t.19  
 Location (for instructors, trainers, technicians): t.131  
 Location (of fencers, judges): t.30, t.48, t.66  
 Loss of ground: t.35, t.144.1, t.146; see «Ground gained/lost»  
 Lunge: t.9, t.83, t.101  
 Localisation of a fault in equipment: t.56, t.80, t.95, t.99  
 Manifest cheating with equipment: t.70, t.73, t.170  
 Mask: t.20.2, t.64, t.66.1, t.68.1, t.71, t.72, t.73.1.g, t.115, t.123, t.125, t.170  
 Match: t.3, t.4, t.38, t.41.4/5, t.44.3, t.45.1/4, t.48.4, t.49, t.51, t.62.3, t.64, t.74.2, t.114, t.118, t.124, t.132, t.160, t.163, t.170  
 Material; see «Bodywire», «Checking (equipment)», «Mask»  
 Materiality of hits: t.54, t.59, t.82, t.92, t.99  
 Medical Commission: «Medical delegate»  
 Medical delegate: t.45, t.116  
 Medical reason: t.45  
 Method (of fencing): t.76, t.90, t.96  
 Method (of holding weapon): t.21  
 Method (of decision): t.177  
~~Modification to Rules: t.1~~  
 Modification of order of bouts: t.45.5  
 Momentary pause: t.89.4.c, t.89.5.d, t.106.3.c, t.106.4.d  
 Name (on back): t.74.1, t.75.1, t.170  
 Nationality (on back): t.74.1, t.75.1, t.170  
 National logo: t.74.2, t.75.2, t.170  
 Neutrality: t.30.1; see «Referee», «Judges»  
 Non-combativity: t.124  
 Non-presentation: t.118, t.119, t.170  
 Non-regulation equipment: t.70, t.72, t.73, t.170  
 Non-sword arm: t.29, t.30, t.48.1, t.133, t.170  
 Number of hits: t.38, t.40, t.41.4; see also «Hits»  
 Obedience: t.108, t.109, t.112, t.170  
~~Obligatory application of Rules: t.1~~  
 Offences: t.144, t.161, t.164-170, t.178; see also «Forbidden»

Offensive actions: t.9.1, t.10, t.12, t.13, t.76, t.83, t.101  
 Official delegate: t.46.2, t.111,  
 Official competitions of FIE: ~~t.4~~, t.37.2, t.47, t.113, t.139  
 Olympic Games: ~~t.4~~, t.66.1, t.73.2, t.135, t.142, t.157  
 On guard: t.19, t.22, t.31, t.32, t.64, t.72, t.89.6, t.106.5  
 One-two: t.11.2  
 Order, disturbing good: t.108, t.109, t.111, t.112, t.133, t.137.1, t.139, t.144.2, t.162.4, t.168, t.170, t.178  
 Organising Committee: t.68.3, t.111, t.129, t.142, t.157  
 Orthopaedic (handle): t.21  
 P-cards (Yellow, Red, Black): t.124, t.170  
 Parry: t.9.2, t.11, t.14, t.78, ~~t.84~~, t.86, t.89.4, t.102.3, t.105, t.106.3/4  
 Passing opponent: t.28  
 Penalties: t.137, t.139, t.144, t.145, t.157, t.159-t.164, t.170, t.171  
 Penalties (fencing): t.144.1-~~t.146~~  
 Penalties (disciplinary): t.144.2, t.150-156  
 Penalties (table of): t.170  
 Penalties (types): t.144, t.158, t.162  
 Period (direct elimination bout): t.22.7, t.39, t.40, t.42, t.48.4. t.124.1  
 Permanent suspension: t.139, t.144.2, t.145, t.153, t.156  
 Permission to leave piste: t.23.6, t.170  
 Piste: t.17-19, t.22, t.33-36, t.94, ~~t.95-3~~, t.170; see also below, and «Crossing limits of piste», Ground gained/lost»  
 Piste Enclosure: t.131.3, t.132, t.170  
 Piste (place nearby for instructors, trainers, technicians): t.131, t.132  
 Piste (straightening weapon on): t.76.2, t.90.2, t.96.5, t.170  
~~Placing on guard: t.19, t.22~~  
 Plastron (conductive): see also «Jacket (conductive)»  
 Plastron (protective): t.20.2, t.64.5, t.66.1, t.71, t.73.1; see also «Underplastron»  
 Pledge of honour (referees and judges): t.46  
 Pledge of honour (fencers): t.112  
 Plug (bodywire): t.47.2.d, t. t.95.1, t.115; see also «Bodywire»  
 Plugging in of bodywire: t. 66.2, t.115  
 Point in line: t.15, t.22.4, t.22.12, t.84.1/2, t.89.4/5, t.102, t.106.3/4  
 Pointe d'arrêt (button): t.68.3, t.72  
 Points: t.149  
 Presentation on time: t.114, 118, t.119, t.170  
~~President of jury: see «Referee»~~  
 Priority of hit: t.59, t.81.2, t.82, t.84, t.85, t.100, t.104.1, t.172.2  
 Procedure for checking the equipment by the Referee: t.64-68  
 Protection (of the valid target): t.29, t.30, t.79.1, t.170  
 Protective plastron: t.64.5, t.66.1, t.71, t.73.1.g  
 Protest (procedure): t.130, t.172, t.175  
 Protests: see «Appeals»  
 Punctuality: t.114, t.118, t.119, t.170  
 Pushing point on the piste: t.76, t.90, t.170  
 Red Card: t.29, ~~t.74.2~~, t.119, t.132.2, t.162, t.163, t.165, t.166, 167, t.170  
 Redoublement: t.13.2, t.89.4/~~65~~, t.106.3-~~e~~/5  
 Referee: t.22, ~~t.23~~-33, t.37-40, t.44, ~~t.46~~-59, t.64-67, t.71-73, t.109-112, t.122-124, t.137, t.164, t.172  
 Referee (designation): t.46, t.50  
 Referee (candidate): t.47  
 Referee (checking): t.47, t.64-73, t.114, t.137  
 Referee (judging of hits): t.53-59, t.81-89, t.92-95, t.99-106, t.137  
 Referee (signals and commands): t.63 (Figure 3)  
 Refereeing delegate: t.50, t.51, 52, t.111, t.130, t.135, t.138, ~~t.140~~, ~~t.~~-141, t.143, t.174  
 Refusal (to award a hit): t.23, t.25, t.27-29, t.33, t.56-57, t.73, t.79-81.1, t.89.2, t.93-94, t.96.3, t.97, t.99, t.101.5, t.106.1, t.121.2, t.144.1, t.147, t.161, t.170  
 Refusal (to fight an opponent): t.113, t.170  
 Refusal (to obey): t.108, t.170  
 Registration of hits: t.28.3, t.38, t.44, t.47.2.k, t.48.1, t.54, t.55, t.56, t.58, t.69.3, t.72, t.79.1.b, t.80, t.81-~~5~~, t.92, t.96.3, t.98, t.99

Remise: t.13.1, t.89.4.c, t.89.5.f, t.106.3.c, t.106.3.f  
 Repetition of offence: t.178; see also «Penalties»  
 Replacing fencer: t.45  
 Replacing referee, judge: t.50.4  
~~Replacing on guard: t.22.3/9, t.28, t.32, t.35, t.89.6, t.106.5~~  
 Reprise of attack: t.13.3, t.89.4.c, t.89/5/f, t.106.3.c, t.106.3.f  
 Reserve equipment: t.69  
 Residual travel: t.68.3  
 Respect of the fencing phrase: see «Fencing (respect of phrase)»  
 Responsibility of fencers: t.20, t.121-123, t.125-133  
 Rest (one minute): t.39, t.42  
 Restarting bout: t.56, t.99  
 Result: see «Score»  
 Retirement: see «Withdrawal»  
 Retreat: t.13, t.18: see «Ground gained/lost»  
 Right of defence: t.176  
 Right-handed: t.22  
 Riposte: t.9, t.11, t.13.1, t.26.2, t.85.2, t.86, t.87, t.89.5.c/f, t.103.21, t.104.2, t.105.1, 106.3.c/f  
 Sabre: t.21.3, t.22.12, t.24, t.33.4, t.39, t.42, t.64.4, t.96 - t.106, t.170  
 Safety: t.20  
 Safety device: t.95.1  
 Salute: t.122, t.145.2, t.170  
 Score (sheet): t.38, t.40.4, t.45.1, t.50.7, t.124.3.e, ~~t.127~~, t.163, t.168  
 Scorers: t.47.2.e  
 Season, active: t.47, 50.3, t.159, t.162.3, t.167.2, t.169, t.170  
~~Seeking corps à corps: t.25, t.26, t.170~~  
 Shake hands: t.122  
 SEMI (Committee): t.56.7, t.66.1, t.73.2  
 Semi-final: t.18.3, t.50.5  
 Simultaneous action: t.89, t.106  
 Signals (audible): t.44.1  
 Signals (Referee): see «Referee (signals and commands)»  
 Signals (visual): see «Lamps»  
 Simple actions: t.8, t.10, t.11, t.13, t.14, t.33.2, t.83.2, t.84.3, t.86, t.89.4.a/5.f, t.101.3/4, t.105.1, t.106.3.a/4.f  
 Special device (handle): t.21  
 Spectators: t.23.5, t.37, t.61.4, t.107.1, t.122, t.133, t.137.3, t.152, t.170  
 Spool: t.28.3  
 Sports Arbitration Tribunal (TAS): t.135, t.143.3  
 Sportsmanship: t.121.2, t.123v, t.128, t.129, t.144.2, t.170, t.178  
 Starting bout: t.22, t.23, t.64, t.66, t.115, t.118, t.122, t.170  
 Statutes (FIE): t.108.1, t.113.2, t.134, t.176  
 Step forward: t.83.2.c, t.84.3, t.101.4, t.170  
 Step back: t.35.1, t.146,  
 Stop hit: t.12, t.13.3, t.88, t.89.4.a,d, t.89.5.d, t.103.32, t.106.3.a,d, t.106.4.d  
 Stopping bout: see «Interruption of a bout»  
 Straightening blade on the piste: t.76.2, t.90.2, t.96.5, t.170  
 Strip: see «Piste»  
 Substitution of target: t.29, t.30, t.48, t.79.1, t.97.2, t.170: see «Valid target»  
 Substitution and use of non-sword arm: t.29, t.30, t.48.1, t.170  
 Surface (non-valid): t.29, t.30.2, t.55.2, t.89. t.94.5  
 Surface (valid): see «Valid target»  
 Suspension (decision/penalty): t.136-137, t.139, t.143.4, t.144.2, t.145, t.153.1, t.155, t.156, t.159, t.162.3, t.167.2, t.169, t.170  
~~Suspension: t.156, t.170, t.176~~  
 Supervisor: t.20, t.45.1, t.135, t.138-141, t.143.2, t.169.2, t.174  
 Take hold of electrical equipment with non-sword arm: t.29.3, t.170  
 Taking off mask before 'Halt!': t.125, t.170  
 Target: see «Valid target»  
 TAS (Sports Arbitration Tribunal): t.135, t.143.3  
 Team (captain): t.46.2, t.47.2.d, t.67, t.109, t.118.3, t.130, t.132, t.173

Team competition: t.41, t.50.4, t.51, t.119, t.124.3, t.132, t.170  
 Team (replacement of a fencer): t.45  
 Team enclosure: t.132.1  
 Tearing out of spool: t.28.3  
 Technician: t.56.7, t.131.1, t.152  
 Temporary suspension: t.144.2, t.145.2, t.155, ~~t.170~~  
 Tests (equipment): t.47.2.d, t.56.5/6, t.57, t.80, ~~t.81~~, t.99  
 Third place (deciding, in case of disqualification): t.149  
 Threaten valid target: t.9, t.15, t.83.2, t.101.2, t.103.1  
 Throwing (mask): t.123  
 Throwing (weapon): t.21.2  
 Thrusting (weapons of): t.76, t.90, t.96  
 Time (fencing): t.8, t.12.3, t.22.7, t.37, t.38, t.40-44, t.88, t.89.3, t.103.2, t.106.2  
 Time (remaining/expiry): t.43  
 Time-keeper: t.37.2, t.44.2, t.47.2-~~qe~~  
 Tournament: ~~t.54~~ t.46.2, t.144.2, t.151, t.152, t.159, t.160, t.162.3, t.167.2, t.169.1, t.170, t.178.2: see «World Cup», «Competitions»  
 Trainer: t.46.2, t.107, t.118.3, t.131, t.137.3, t.152  
 Travel (of the point): t.68.3, t.72  
 Tribunal: t.135, t.143, t.169.2  
 Turn back on opponent: t.27.2, t.170  
 Unarmed hand: t.27.1, t.48.1, t.115, t.148  
 Under-plastron: t.20.2, t.64.5, t.66.1, t.71, t.73.1  
 Undressing (forbidden on the piste): t.116, t.170  
 Unplugging of bodywire: t.47.2, t.95,  
 Unwillingness to fight (passivity): t.124  
 Use of non-sword hand/arm: t.29, t.30, t.48, t.170  
 Utmost ability (fence to): t.128, t.149.1, t.170  
 Valid target (covering and substitution): t.29, t.30, t.48, t.79.1, t.97.1, t.170  
 Valid target (definition): t.77, t.91, t.97,  
 Valid target (threaten): t.9, t.15, t.83, t.101.2, t.103.1  
 Validity of hit: t.59, t.82, t.100  
 Venue: t.111, t.134, t.137.3, t.145.2, t.151, t.152, t.162.4  
 Vest: see «Jacket (conductive)», «Jacket (fencing)»  
 Veterans: t.42  
 Video consultant: t.49, t.50, t.61.3, t.62-4  
 Video refereeing: t.49, t.60-62  
 Violence: t.25.3, t.121.2, t.123, t.147, t.149, t.170  
 Violent fencing: t.121.2, t.149, t.170  
 Visual signals: see «Lamps»  
 Warming up (clothing): t.20.2, t.170  
 Warning (penalty): t.72, t.132.2, t.162.1, t.165, t.168, t.170  
 Weapon (throwing): t.21.2  
 Weapon (working order/spare): t.70, t.114, t.115, t.117, t.170  
 Weapon control: t.64, t.66, t.170  
 Width of piste: see «Piste»  
 Withdrawal: t.45  
 World Championships: ~~t.1~~, ~~t.44.1~~, t.66.1, t.73.2, ~~t.74.2~~, t.159, t.167, t.169, t.170  
 World Cup: ~~t.1~~, ~~t.44.1~~, t.51, t.52, t.66.1, t.74.2, ~~t.170~~  
~~World Cup: t.52~~  
 Yellow Card: t.20.2, t.119, t.162.1, t.163, t.165, t.168.1, t.170  
~~Zonal Championships: t.44.1, t.74.2, t.170~~

**Rules Commission:** In favour.

**Opinion of the Executive Committee:** In favour of the proposal.



**Proposals for the 2023 Congress  
Modifications of the Material Rules**

**The texts below are applicable on January 1st, 2024, unless mentioned otherwise.**



**Article: m.25.3.h****Proposal from: SEMI Commission**

**Motivation:** The growing number of past Word Champions (36 per year) means that in about ten years we will end up with at least 250 red writings on the field.

In this way there is no longer any added value for the different colour.

On the other hand, it is acceptable that there are no time limits for the writing of the Olympic Champions.

**m.25.3.h**

A World Champion has the right to have his/her name and the abbreviation of his/her national federation printed in red **for the following season**.

An Olympic Champion has the right to have his/her name and the abbreviation of his/her national federation printed in gold.

**PCM Commission:** In favour.

**Athletes Commission:** In favour.

**Rules Commission:** In favour, with the modification:

An Olympic Champion has the right to have his/her name and the abbreviation of his/her national federation printed in gold **until the end of the next Olympic Games**.

**SEMI Commission:** In favour as amended. It is difficult in weapon control to verify who is entitled.

**Motivation:** The growing number of past Word Champions (36 per year) means that in about ten years we will end up with at least 250 red writings on the field.

In this way there is no longer any added value for the different colour.

~~On the other hand, it is acceptable that there are no time limits for the writing of the Olympic Champions.~~

**m.25.3.h**

~~A World Champion has the right to have his/her name and the abbreviation of his/her national federation printed in red for the following season.~~

~~An Olympic Champion has the right to have his/her name and the abbreviation of his/her national federation printed in gold.~~

**Opinion of the Executive Committee:** In favour of the following proposal:



A World Champion has the right to have his/her name and the abbreviation of his/her national federation printed in red [for the following season](#).

An Olympic Champion has the right to have his/her name and the abbreviation of his/her national federation printed in gold [until the end of the next Olympic Games](#).

---

P.46

**Article:** [m.30.1](#)

**Proposal from:** Refereeing Commission

**Motivation:** To make clear that foil and sabre masks cannot be used in epee events

#### RULES SPECIFIC TO EPEE

##### Mask

**m.30. 1.** The mask must not be covered, in whole or in part, by [conductive material or](#) material which can **cause the point to glance off** (cf. m.25).

**2.** The mask must be so shaped that the **bib** reaches below the prominences of the collar bones (clavicles).

**Refereeing Commission:** In favour.

**SEMI Commission:** In favour.

**Rules Commission:** In favour.

**Opinion of the Executive Committee:** In favour of the proposal.

---

P. 47

**Article:** [Annex A 4 Label of quality, Material Rules \(see Urgent letter 2/2022\)](#)

**Proposal from:** SEMI Commission - deferred proposal from the 2022 Congress

**Motivation:** The installation of this RFID into the fencing clothing (mask, under plastron, jacket and breeches) is suspended until further notice.

Therefore, the manufacturers will be allowed to use for 2022 (is yearly dated) the old technical FIE mark (round). It will also be necessary to postpone the final date at which all the equipment must have the RFID and the new quality seal, from the season 2026/2027 to the season 2027/2028.

Due to the current situation, the orders to the company and deliveries of RFID are currently suspended. In the meantime, we are trying to find other companies that can produce and deliver these chips.

## 2. Chip and label installation requirements. Page 80

From 01.03.2021, the **obligatory** chipping of new fencing equipment (jacket, trousers, plastron mask) has been introduced. **It will be mandatory from 01.01.2023.**

Both variants of the FIE seal of quality are acceptable up to and including the **2026/2027 2025/2026** season.

For the **2027/2028 2026/2027** season, masks, jackets, breeches and plastrons must have the new quality seal with a chip securely located underneath.

### **SEMI Commission:** In favour as amended also delete drawings

Therefore, the manufacturers will be allowed to use ~~for 2022 (is yearly dated)~~ the old technical FIE mark (round). It will also be necessary to postpone the final date at which all the equipment must have the RFID and the new quality seal, ~~from the season 2026/2027 to the season 2027/2028.~~

### 3 Chip and label installation requirements **are suspended**

~~From 01.03.2021, the obligatory chipping of new fencing equipment (jacket, trousers, plastron mask) has been introduced. It will be mandatory from 01.01.2023.~~

~~Both variants of the FIE seal of quality are acceptable up to and including the 2026/2027 2025/2026 season.~~

~~For the 2027/2028 2026/2027 season, masks, jackets, breeches and plastrons must have the new quality seal with a chip securely located underneath.~~

~~Cancellation of the text while waiting for a new system.~~

**Rules Commission:** Cancelled pending a new system.

**Opinion of the Executive Committee:** Agrees with the SEMI and Rules Commissions. The rule on chipping must be cancelled until a new viable solution is found and submitted to the Congress.

---

**Article:** **Annex A, 4.4**

**Proposal from:** SEMI Commission

**Motivation:** The sentence is remaining into the rule after the introduction of the tests for the sabre maraging blades, but is no more actually and the test to carry on at today is the K1C.

P.48

#### **Annex A, 4.4**

#### **4.4. Test of strength at the fracture toughness point, K<sub>1C</sub>**

The ~~K<sub>1C</sub>~~ K<sub>1C</sub> value of the steel must be measured by traction on a CT sample which has the dimensions indicated at the end of this annexe (Table VIII), made from materials subjected to the same thermal treatment as required for the blades, notched mechanically initiating a fatigue crack at the apex of the notch. The test must be conducted according to the methods indicated by the standard ASTM E 399. The value must conform to that laid down in Table I.

~~In cases where it is not possible to obtain a CT sample, the factor of increasing levels of dynamic loading (K<sub>1d</sub>) may be determined instead of the K<sub>1C</sub> value.~~

**SEMI Commission:** In favour.

**Rules Commission:** In favour.

**Opinion of the Executive Committee:** In favour of the proposal.

---



## Proposals for the 2023 Congress

### Modifications of the Publicity Code

The texts below are applicable on January 1st, 2024, unless mentioned otherwise.

---

**Article:** p.12.2

P. 49

**Proposal from:** SEMI Commission

**Urgent decision of the 27.03.2023 (cfr. Information letter 3-23)**

**Motivation:** During the European Championships has been noted the lack on the Publicity Rules of a regulation concerning the application of the advertising logos on the thigh of the sabre fencers instead of the arm.

To avoid misunderstanding for the next World Championships in Cairo and to clarify once for all the rule, applying a custom of twelve years now, the following modification of the Publicity Rulebook is proposed:

*p. 12.2. Fencing clothing and equipment*

a) If a federation and/or a fencer have signed a **sponsorship contract** with a commercial or other company, the logo of that sponsorship partner may be fixed **at a rate of maximum of 3 logos, with a maximum area of 85 cm<sup>2</sup> each;**

**In foil and epee:** at the top of the sleeve of the non-sword arm of the fencing jacket; **in sabre:** at the top of the thigh of the non-sword side of the fencing breeches and clearly separated from the national logo.

**Opinion of the Executive Committee:** In favour of the proposal.

---

**RAPPORT DE LA COMMISSION DES ATHLETES LA FIE  
FIE ATHLETES COMMISSION REPORT  
INFORME DE LA COMISION DE LOS ATLETAS DE LA FIE**

<b>Date, lieu et heure de la réunion :</b> <b>Date, place and time of the meeting:</b> <b>Fecha, lugar y horario de la reunión:</b>	<b>7 JULY 2023</b> <b>13:00</b>
<b>Participants:</b> <b>Participants:</b> <b>Participantes:</b>	1. RUBEN LIMARDO 2. ALEXANDER MASSIALAS 3. ALEXANDRA NDOLO 4. GERGELY SIKLOSI 5. SARRA BESBES 6. JESSICA GUO 7. JIRI BERAN 8. OLGA KHARLAN
<b>Absences (indiquer si l'absence avait été annoncée) :</b> <b>Absent (indicate if the absence had been announced):</b> <b>Ausencias (indicar si la ausencia fue anunciada):</b>	1. YANNICK BOREL 2. ELMIR ALIMZHANOV 3. SU YIWEN

**INTRODUCTION  
INTRODUCTION  
INTRODUCCIÓN**

**RAPPORT DE LA RÉUNION  
MEETING REPORT  
INFORME DE LA REUNIÓN**

**Point 1 / Item1 / Punto 1:**

**OPINION TO THE PROPOSALS OF MODIFICATION TO THE RULES:**

Article: t.45

Decision: Disagree, leave the medical break at 5 minutes

Article: t.64 and t.170.4.1

Decision: Agree in theory - but change the language to clearly state: The authorized time is during the one-minute breaks. The athlete should not be allowed to listen to their coach during the fencing. Specify what the mechanism is.

Article: t.84

Decision: Agree

Article: t.109

Decision: Agree

Article: t.111

Decision: Agree

Article: t.124 and o.68

Decision: Agree

Article: m.25.3.h

Decision: Agree

#### OPINION TO THE PROPOSALS OF MODIFICATION TO THE STATUTES:

Art. 4.5

Decision: Agree

The Ethics Committee held a number of meetings between July 2022 and the end of June 2023 to deal with the cases referred to it and to consider certain improvements to procedures in the area of ethics.

In summary, the activities were as follows:

### **1. Cases referred to the Ethics Committee**

4 cases were referred to the Ethics Committee.

For reasons of confidentiality inherent in the activities of the Ethics Committee, this report cannot give further details on the cases referred to it, which in summary concern the European Fencing Confederation, the proceedings of the last FIE Congress and the problematic situation arising from Russia's war in Ukraine.

All these cases were dealt with, and answers were given to the various stakeholders.

The Ethics Committee notes that, in certain cases, its role is not yet very well perceived by the members of the fencing family, given that the said Ethics Committee can only intervene within the framework of the prerogatives and competences conferred upon it by the FIE Statutes.

It is therefore recommended that, in the future, efforts be made to improve communication and information for FIE members on the exact role of the Ethics Committee, which is available to intervene in this area if the FIE so requests.

### **2. Code of procedure for handling ethical cases**

As the Ethics Committee has had very few cases referred to it in recent years, it has been able to act with due regard for the rights of those involved, in particular their right to be heard, but has had to proceed without being able to rely on the rules of procedure established for this activity.

For this reason, he asked the FIE to appoint a lawyer to draw up a code of procedure along the lines of what other international federations have done.

After various discussions with the FIE Legal Commission and the Executive Committee, this request from the Ethics Committee was accepted and a mandate was given to a specialist in sports law, Mr Jorge IBAROLLA, Libra Law ([libra-law.ch](http://libra-law.ch)), who worked on drawing up this code of procedure.

The Code has been examined by the Ethics Committee, which has approved it in its entirety, given that it is an excellent piece of work, subject to a few minor amendments which will be discussed and made to the text.

This text has also been submitted to the FIE's Legal Commission with a view to its adoption at the next FIE Congress, which will take place in Sharm El-Sheik on 25 November 2023.

The adoption of this text, which the Ethics Committee would like to see, will also enable the FIE to submit to the Congress delegates the possibility of increasing the number of members on the Ethics Committee in order to facilitate the management of cases, particularly with regard to the skills, nationalities and potential conflicts of interest that a member of the Ethics Committee could have in relation to certain cases.

It should also be noted that, in the current context, the Ethics Committee operates with 5 members, which makes discussions considerably more cumbersome when urgent decisions have to be taken.

The Procedural Code will make it possible to appoint a panel of 3 people who can, on a case-by-case basis, act with greater ease when deadlines are short, while also taking into account the various criteria mentioned above in order to avoid any conflict of interest.

The Ethics Committee would like to thank Mr Jorge IBAROLLA and the FIE for their excellent collaboration in putting this code in place, which will enable significant progress to be made in the area of ethics procedures.

### **3. New recommendations**

As the role of the Ethics Committee is also to suggest improvements or new ideas, we thought it would be a good idea for it to be involved in the analysis of candidates when a new Chairman or Executive Committee member is elected.

After internal discussions within the Ethics Committee, it came to the conclusion that this idea should be proposed to the Legal Commission, but in a restricted form, i.e. that the Ethics Committee should only be involved in analysing possible candidates for the presidency, and not those for the Executive Committee, as this would represent too much work and would therefore be difficult for the Ethics Committee to manage.

On the other hand, it notes that other international federations have put in place certain rules whereby they involve the Ethics Committee in the analysis and acceptance of candidates for the presidency.

This idea has been submitted to the Legal Committee for consideration and, if it is successful, to define the framework.

In this context, the Ethics Committee is of the opinion that its power, at this stage, should be that of a recommendation to be made to Comex as to whether or not to accept a candidacy for the presidency, but without giving the Ethics Committee the power to decide on a candidacy.

\* \* \*

The Ethics Committee has worked smoothly over the past year and looks forward to continuing its work in this context until the end of 2024, when new elections will be held.

Lausanne, 11 August 2023



Olivier CARRARD  
President





## Proposals for the 2023 Congress

### Modifications of the Statutes

The texts below are applicable on January 1st, 2024, unless mentioned otherwise.

---

**Article:** 4.4 and 6.9

P.10

**Proposal from:** Legal Commission

**(Deferred proposal from Congress 2022)**

**Motivation:** To bring the Committee into line with the Commissions, to increase its availability to both ensure the FIE's observance of its Code of Ethics and to provide a viable quorum of neutral members when required.

#### 4.4 ELECTION OF COMMISSIONS (OTHER THAN THE ATHLETES COMMISSION) AND THE ETHICS COMMITTEE

4.4.3 a) For the elections to the permanent commissions and the Ethics Committee, the 10 candidates with the most votes are elected subject to the fact that they must be of different nationalities.

~~b) For the election to the Ethics Committee, the 5 candidates with the most votes are elected subject to the fact that they must be of different nationalities.~~

4.4.4 a) If the 10 candidates to a Commission or the Ethics Committee who have obtained the most votes do not include at least 3 persons of each gender, the Commission will consist of the 3 candidates of the under-represented gender who have obtained the greatest number of votes and the 7 candidates of the other gender who have obtained the greatest number of votes.

~~b) For the Ethics Committee, if the 5 members who have obtained the most votes do not include at least 2 persons of each gender, the Committee will consist of 2 candidates of the under-represented gender who have obtained the greatest number of votes and 3 candidates of the other gender who have obtained the greatest number of votes~~

#### 6.9 THE ETHICS COMMITTEE

The Ethics Committee is made up of **five ten** voting members elected by the Congress.

**Opinion of the Ethics Committee:**

**RAPPORT DE LA COMMISSION JURIDIQUE DE LA FIE**  
**FIE LEGAL COMMISSION REPORT**  
**INFORME DE LA COMISIÓN JURÍDICA DE LA FIE**

<b>Date, lieu et heure de la réunion :</b> <b>Date, place and time of the meeting:</b> <b>Fecha, lugar y horario de la reunión:</b>	<b>7 July 2023, by zoom</b>
<b>Participants:</b> <b>Participants:</b> <b>Participantes:</b>	<ol style="list-style-type: none"> <li>1. El HADUARI Mohammed</li> <li>2. IONESCU Anca</li> <li>3. JACOBS Peter</li> <li>4. RAPP Gordon</li> <li>5. SAMIR Ahmed</li> <li>6. SINYAVSKAYA Maria</li> <li>7. RIOJA PEREZ, Marco</li> <li>8. SZEGLEDI Edina</li> </ol> <p>PEROVIC Novak, representative of the Executive Committee</p>
<b>Absences (indiquer si l'absence avait été annoncée) :</b> <b>Absent (indicate if the absence had been announced):</b> <b>Ausencias (indicar si la ausencia fue anunciada):</b>	<ol style="list-style-type: none"> <li>1. CHERIS Sam (announced)</li> <li>2. ATALI Murat (not announced)</li> </ol>

**INTRODUCTION**  
**INTRODUCTION**  
**INTRODUCCIÓN**

The meeting commenced shortly after 13.15 CET and ended at 18.00 CET under the chairmanship of Peter JACOBS and Marco RIOJA, Sam Cheris having sadly submitted his apologies. It was joined briefly at different times by the Ethics Committee, the Medical Commission and the president of the Women and Fencing Council.

**RAPPORT DE LA RÉUNION**  
**MEETING REPORT**  
**INFORME DE LA REUNIÓN**

**Point 1 / Item 1 / Punto 1:**

Not in favour of the proposition.

There are no legal reasons for this requirement, it is not necessary for transparency as the congress report is published later in the year and it is contentious in terms of outside pressures, of the implications for congress attendees of unwanted social media attention.

**Point 2 / Item 2 / Punto 2:**

In favour of the proposition.

The Commission would like to add the attendance of presidents of commissions, councils and committees, so that paragraph 2 of the proposal would read (added words highlighted in yellow):-

At FIE Elective Congresses, the FIE member Federations may be represented by 2 delegates. Members of the Executive Committee, presidents of commissions, councils and committees and candidates to elected positions have the right to take part in the FIE Elective Congresses.

The commission considers that as the congress might discuss matters relating to the work of these bodies their presidents should have the right to be present to represent them and to assist the Congress better to understand the topic concerned.

### **Point 3 / Item 3 / Punto 3:**

In favour of the proposition.

The Commission however proposes the modification of the proposition as follows:-

A candidate for the Medical Commission - must have completed the educational requirements for being an MD, DO or DC ~~or have practiced as a physiotherapist, or have been a member of the Commission for at least 8 years and hold a valid and active licence, or be qualified and be practicing as a physiotherapist.~~

The Commission considers that to ensure they maintain their knowledge and skills up to date through continuous professional development it is necessary that its members are currently qualified to practice, and that therefore the clause in the following propositions accepting previous membership of the commission as a criterion for candidature, in order to benefit from their experience, is not appropriate.

### **Point 4 / Item 4 / Punto 4:**

In favour of the proposition.

The Commission however proposes to change 'the' to 'this', for the sake of clarity, and delete the last 4 words (for at least 8 years), as unnecessary, so as to read:-

A candidate for the Legal Commission – must have the educational requirements or ~~be practising~~ have practiced as a lawyer, judge or notary or have been a member of this Commission

### **Point 5 / Item 5 / Punto 5:**

In favour of the proposition.

The Commission however proposes to change 'the' to 'this', for the sake of clarity, delete the last 4 words (for at least 8 years), as unnecessary, so as to read:-

A candidate for the Promotion, Communication and Marketing Commission must have a college or university degree in marketing or communications and have held a management position in marketing or communications or have been the producer of films, or have been a member of **this** Commission.

**Point 6/ Item6 / Punto 6:**

In favour of the first half of the proposition (up to “been part of the master list”). The commission proposes however to replace “have refereed, at least once, in one weapon, in the table of 32/16 or eight... etc” by “have refereed, at least once, in one weapon, in the table of 16 or eight ..... etc”.

Not in favour of the second part modifications (“Being a member ..... National Federation” as being too wide-ranging and potentially penalizing smaller federations where members fulfill multiple roles:-

A candidate for the Refereeing Commission must:

- be or have been an FIE category B or A referees in at least two weapons; and
- be a current member **or have already been a member** of the Refereeing Commission, or have refereed in official FIE competitions in at least two weapons in at least two (2) of the 4 fencing seasons (1 September to 31 August) preceding his candidature; and
- have refereed, at least once, in one weapon, in the table of **16 or eight or semi-final or final** of the individual or team event of a senior World Cup, or a Grand Prix, or a World Championships or the Olympic Games of the 4 fencing seasons preceding his candidature **or have been part of the master list**.

Once elected, the Refereeing Commission member shall send to the FIE head-office a letter of commitment signed by both the Refereeing Commission member and his/her national federation.

**Point 7/ Item7 / Punto 7:**

In favour of the proposition. The Commission however proposes to change ‘the’ to ‘this’, for the sake of clarity, and delete the last 4 words (**for at least 8 years**), as unnecessary, so as to read:-

A candidate for the Rules Commission must have been an active ‘A’ or ‘B’ rated referee or have officiated, at least twice, as a president of the DT at a Zonal Championship or as a member of the DT at a World Championship or as a member of the DT at an Olympic Games, or have been a member of **this** Commission.

**Point 8/ Item 8 / Punto 8 :**

In favour of the proposition. The commission would like to modify the text of the proposition by changing ‘the’ to ‘this’, for the sake of clarity, deleting its last four words (**for at least 8 years**), and adding an additional paragraph (**‘Be a member or ....’**) as follows:-

A candidate for the - SEMI Commission **must** have a college degree in engineering or science or be practising as an engineer **or have been a member of this** Commission, **and**

**Be a member or have already been a member of the SEMI Commission of a National Federation or fulfilled an equivalent role, or have officiated at least twice at weapon control or as a technician at Zonal Championship or a World Championship or an Olympic Games**

The commission notes the risk of candidates for the commission having all the academic qualifications required but no experience of the sport of fencing and therefore of practical fencing-related applications, and therefore proposes this additional second paragraph.

**Point 9/ Item 9 / Punto 9 :**

In favour.

**Point 10/ Item 10 / Punto 10 :**

In favour.

**Point 11/ Item 11 / Punto 11 :**

Not in favour.

The proposal would allow a president of a confederation or the president of the athletes' commission to become secretary general, secretary-treasurer or a vice president of the FIE. But these persons' situation in the Executive committee is different from that of the other members, in that they have been elected to that position by a body other than the Elective Congress of the FIE and therefore do not carry the mandate of all the FIE members. They are also likely to perceive their role as representing the interests of their confederation or the athletes rather than the whole FIE; and at a practical level the workload of a confederation president is incompatible with taking on the heavy burden of FIE secretary general or secretary-treasurer

**Point 12/ Item 12 / Punto 12 :**

In favour.

**Point 13/ Item 13 / Punto 13 :**

In favour. The commission would however like to modify the text of the proposition by adding the clause highlighted in yellow as follows:-

Zonal Confederations shall appoint at least one person to serve as a Safeguarding Officer at each Zonal Championship. All safeguarding reports which are not resolved through mediation must be reported to the FIE in accordance with the underlying safeguarding rules of the FIE.

The commission asks for this addition to help ensure the confidentiality of such reports.

**Other points**

A) The commission met with the Ethics Committee at their request. They raised two points:-

1) The need to draw up a procedural code for ethical issues. Maitre Carrard informed the Legal Commission that the lawyer Jorge Ibarrola, who has already advised the FIE on other matters, had been commissioned to prepare this code. It was agreed that the Ethics Committee will send it to the Legal Commission for review when it is finished.

2) They informed the Legal Committee that they had discussed as a proposal amongst ideas new ideas, to improve the contributions of the Ethics Committee, the suggestion that they should analyse the compliance with ethical requirements and principles of candidates for the most senior FIE positions; they suggested that it should only consist of an opinion, without going any further in its consequences. This idea would be given further consideration by them.

B) The commission met briefly with the Medical Commission at the Legal Commission's request to obtain technical medical confirmation of aspects of the text for Medical Commission. The discussion contributed to the Legal Commission's subsequent finalizing of its recommended text (see point 3 above).

C) The commission met briefly with the president of the Women and Fencing Council at the Legal Commission's request to discuss their second proposition (point 13 above) – there was concern in the Legal Commission over the confidentiality implications of the proposition. After some discussion it was mutually agreed that adding the final clause 'in accordance with the underlying safeguarding rules of the FIE' satisfied this concern.

Template of Statutes – FIE member country

## **CHAPTER I - MISSION**

Introduction

Fencing federation of X date of foundation.

Date and occasion of approval of current statutes

### **1.1: Mission**

Federation X is an independent organisation recognised by NOC of country X as sole body governing sport of fencing in country X.

Its statutes and regulations comply with the Olympic Charter, the Statutes, Rules and regulations of the FIE and the anti-doping rules of the FIE and WADA; if any conflict arises between its statutes and regulations and the Statutes and rules of the FIE, those of the FIE take precedence.

### **1.2.Aims.**

Examples; administer sport nationally, manage finances, promote development and spread of sport overall and provide support and advice, promote among children and young people, involvement in education, promote affiliation of clubs, promote safety of and respect for individual, fair play and sportsmanship, promote respect for environment, apply FIE rules for competitions, organise competitions in country, preparation of national teams, participate in international competitions, ensure independent democratic election processes within electoral cycle, etc etc.

Compulsory aims: to ensure that principle of non-discrimination on grounds of gender, race, ethnicity, religion, political opinion, family status or other is respected: To promote and develop fight against doping: To adhere to the FIE's code of Ethics and its Safeguarding Policy.

### **1.3 Registered office**

Location

### **1.4 Official language**

Official language, if relevant working languages, language of communication with other NFs and FIE.

### **1.5 Financial year**

Start and end

### **1.6 Financial resources**

E.g. subscriptions, licences, sponsorship, tv, donations etc.

## **CHAPTER II - MEMBERSHIP**

### **2.1 Categories of members**

The Federation can have three (3) categories of members:

- Club or similar member
  - clubs or legal entities that meets membership conditions appropriate to the country
- Individual member
  - An individual member is an administrator of a corporate member, an athlete, a coach, a referee or an official or any other person who satisfies the membership conditions;
- Honorary member
  - An honorary member is an corporate or individual person who was invited by the Board of directors/Executive Committee and/or a General Meeting/Congress to membership for honorary reasons;

### **2.2 Membership conditions**

#### **2.2.1. Clubs or similar member**

Any club or group wishing to become or remain a member of the Federation as a corporate member must, each year, pay the required dues and fill the membership documentation.

The conditions for corporate membership are the following:

- Be a corporation created under the Corporation law (name the precise law applicable to the constitution of corporations in the country) or comply with whatever regulations and requirements the country or other administration applicable requires for the establishment of a sports club, organisation or national federation.
- Have its head office/venue on the territory of (name the country)

#### **2.2.2. Individual member**

Any person wishing to become or remain a member of the Federation as an individual member must, each year, pay the required dues and fill the membership documentation.

To become or remain an individual member, the person must be one of the following:

- An administrator of a corporate member



- An athlete
- A coach
- A referee or other official
- A member of the Board/Executive Committee, a committee, commission etc of the Federation or one of its sub-divisions
- Any other entity/person supporting fencing in a category that the Federation desires as members and satisfies the membership conditions

### **2.2.3. Honourary member**

To become an honorary member, a person or moral person must meet the following criteria:

- Has made a highly significant contribution to the Federation;
- Has been accepted by the Board of directors;

### **2.3 Membership dues**

The amount of the dues for each category of membership is set by decision of the Board of directors. The Board of directors/Executive Committee can impose a special additional membership fee for a specific period of time. No paid or owed membership fee is reimbursed in case of resignation, suspension or expulsion of a member.

### **2.4 Suspension, expulsion, withdrawal and sanctions**

The Board of directors/Executive Committee can suspend, expel, or sanction in any other way deemed appropriate, any member who fails to respect the Statutes, Rules and Policies of the Federation or who adopts a conduct prejudicial to the Federation, as provided in chapter XXX (put the chapter number)

The Board's/Executive Committee's decision is final and does not discharge the member of its previous obligations towards the Federation.

A member can resign from membership at any time by sending a written notice to this effect to the Federation's head office. This resignation takes effect on the date mentioned in the notice or, failing such a mention, on the date it was received at the head office.

### **III THE CONGRESS**

**3.1.-Definition:** paramount governing body of the National Fencing Federation (NF).

**3.2.- Meetings:**

2.1.- Ordinary Congress. Annual

2.2.- Extraordinary Congress. - Extraordinary Congress. Whenever summoned by the President or requested by over two thirds of the Executive Committee/Board members or by typically 10% of the members (% dependant on total number of members).

2.3.- Elective Congress. To elect the President and, where appropriate, the Executive Committee of the NF. Normally every 4 years, coinciding with the Olympic year.

2.4 – whether meetings by zoom etc are allowed?

**3.3.- Role - Functions**

Adoption of agreements on:

- Annual accounts
- Budgets
- Acquisitions or assignments of real estate
- Loans
- Competition calendar
- Modification of Statutes
- Dissolution
- Election of President and, where appropriate, Executive Committee/Board.

**3.4.- Composition and representation**

- Members (athletes, clubs, referees, technicians, Territorial Federations).
- Right to vote
- Representation (powers)
- Limitations of the right to vote, if applicable (current license)

**3.5. Agenda**

- Who determines it (President)
- Who can present proposals (members)
- Deadline for submission of proposals
- Interventions during the congress

**3.6.- Decisions**

- Quorum (50% members present or represented)
- Adoption of agreements
  - Simple majority assumptions
  - Assumptions that require a qualified majority (modification of statutes, dissolution)
- Secret ballot (mandatory in elections or at the request of the president or 10% of the members or when concerning an individual)

**3.7.- Elective Congress**

- Every 4 years
- Presentation of candidacies
- Secret vote
- Voting order

Template of Statutes – FIE member country

## **CHAPTER IV – PROCESS FOR THE ELECTION OF THE OFFICERS, EXECUTIVE COMMITTEE AND ELECTION OR SELECTION OF ANY COMMISSIONS NEEDED TO FULFILL THE WORK OF THE FEDERATION**

### **4.1 Election of President**

Who may nominate candidates for President? Members?

Criteria for nominees for President?

When do nominations have to be made? At the Congress? A period of time before the Congress? How announced?

What is the term of the President? Term limits?

How do you deal with tie votes? Multiple voting system? Youngest elected? Oldest elected? Coin flip

### **4.2 Election of Officers**

Who may nominate candidates for officers other than the President? Members? Executive Committee/ Board?

Criteria for nominees for officers?

When do nominations have to be made? At the Congress? A period of time before the Congress? How announced?

Who votes for the officers? Members? Executive Committee/Board?

What is the term of each officer? Term limits?

How do you deal with tie votes? Multiple voting system? Youngest elected? Oldest elected? Coin flip?

### **4.3 Election of Executive Committee/Board**

Who may nominate? Members? Officers? How announced?

Criteria for members of Executive Committee/Board? Gender (Minimum quotas for less represented gender, etc).

Will the officers who are elected become the Executive Committee/Board or members of it? Are they chosen from among the members of the Executive Committee/Board?

Term of office? Term limits?

### **4.4 Election/Selection of Commissions/Committees/Councils**

Which Commissions/Committees/Councils will your federation need? Refereeing? Athletes? (look at FIE and Confederation lists and select those you feel are required to get the federation's work done, Any others?)

Who may nominate? Members? Executive Committee/Board? Can persons self-nominate?  
How announced?

Will your Congress (members) elect the members of the commissions? Will your Executive Committee/ Board select the members of the Commissions? Will the athletes select some or all of the members of the Athletes Commission? Criteria for election/selection generally and specific to particular ones (Minimum quotas for less represented gender, etc).

#### **4.5 Discipline**

Will you have a separate independent disciplinary panel (commission)?

Template of Statutes – FIE member country

## **CHAPTER V – EXECUTIVE COMMITTEE/BOARD**

**Executive Committee/Board** (“EC”) (needed if National Federation (“NF”) needs a smaller body to manage the NF between its Congresses.)

### **5.1 Structure:**

President chairs. Is President technically a member? Will all officers be part of the EC? Will there be at-large members or ex-officio members – how chosen?

### **5.2 Tenure:**

What is term of each of the members? Staggered terms?

Term limits?

How to replace if president/other member dies, is incapacitated or resigns?

### **5.3 Meetings and Decisions**

How often?

How much notice?

In-person or by phone or video?

Majority vote for decisions? 2/3 for certain matters?

### **5.4 EC Functions**

Management between Congresses. List functions.

Relationship to Commissions/Councils. Conflicts of interest (separating roles)

Hire Staff.

Establish competition calendar?

### **5.5 Responsibilities of Officers**

### **5.6 Responsibility of Staff**

Template of Statutes – FIE member country

## **CHAPTER VI – COMMISSIONS AND COUNCILS**

*The establishment of the commissions and councils is not compulsory. Based on the size and activity of the federation, you may choose to establish one or more permanent and/or ad-hoc commissions. You may not wish to use the title ‘Council’ for any such group, but only ‘Commission’ or ‘Committee’.*

*Please see Chapter VI/VIA of the FIE Statutes as an example*

**6.1. List of the permanent Commissions** (e.g. refereeing commission, coach’s commissions, athletes commission, disciplinary commission, ethical commission, organising commission - *there may be others appropriate to your federation*).

1. List of ad-hoc Commissions if any
2. List of Councils, if any

### **6.2 Regarding each of the Commissions/ Councils:**

- 1 Function of the Commissions/Councils overall and individually
- 2 Structure of the Commissions/Councils
  - (a) Number of the members
  - (b) (Election procedures of the members,) duration of their mandate. Replacement process in case of resignation, incapacity, death.
  - (c) Election, function and responsibility of the President of the Commissions/Councils

### **6.3....Meetings, decision making procedures of the Commissions/Councils**

## **CHAPTER VII – DISCIPLINE**

*Preamble: Does/will your federation have its own body applying its disciplinary procedures (a commission, the Executive Committee/Board, etc) or will it make use of a juridical body available from its NOC, sports arbitration board, governmental body or similar? Parts of the following are not relevant if an outside body is to be used.*

Look at Chapter VII of the FIE Statutes for example and also the requirements of your local legal jurisdiction.

### **7.1 Disciplinary Code.**

- 1) Jurisdiction. Set a criterion to select the body which has the jurisdiction.
- 2) assure there is a body (usually the executive committee) that execute or control the respect of the decisions;
- 3) List the person subject to disciplinary rules;
- 4) Set the penalties that can be granted (i.e. suspension, expulsion, fines etc.);
- 5) Identify the offences;
- 6) Specify different cases such as, i.e. multiple offences, complicity;
- 7) Set the rules for the proof of the guilt or innocence.

### **7.2 Disciplinary Procedure;**

#### **The Complaint**

- 1) set up the complaint rules, i.e., identify persons that can make a complaint, identify the persons who can be the object of a complaint (the defendants) and spell out the categories of offences that are subject to the disciplinary process (and those that are not).
- 2) Fix the mandatory content of a complaint (i.e. name, date summary, signature etc.) and a deadline to address such a complaint to the body that holds the jurisdiction;
- 3) Set the composition criteria of the Tribunal and the powers and obligations (Please note that a conflict of interest rule must be applied in fulfilling the composition criteria).

#### **Procedure before the Tribunal**

- 1) identification of the parties;
- 2) fix deadline for providing documents and proof (i.e. list of testimonies etc) for both parties
- 3) set the notification rules (i.e. certified mail etc.) and deadlines.

#### **Hearings**

- 1) Place of the hearings;
- 2) Attendance (shouldn't be mandatory for the parties);
- 3) Witnesses' proceedings rules (In person, in writing, by phone);
- 4) Decision and notification of decision rule.

#### **Appeal;**

- 1) Establish the body in charge for the appeal;
- 2) Deadline of the appeal and form of the application;
- 3) Proceedings (if external body in accordance with the body rule if internal needs to be established a proceeding or the appeal);
- 4) Decision and notification rule.

#### **Emergency;**

Establish a body in charge for the urgent decisions (i.e. suspension until the end of proceedings) and rules.



Template of Statutes – FIE member country

## **CHAPTER VIII – LICENCES**

*Preamble: Note some possible duplication with Chapter II, „Membership“; seek to avoid any contradictions between Chapters II and VIII.*

Who is licensed – competitors? Referees? Coaches? Members of EC, Commissions and Councils? Clubs? Other officials at competitions? Other federation members?

Different levels of licence for different categories?

Annual Fee(s)?

Who may have NF licence? NF passport? Permanent resident? Anyone residing in country? Anyone competing in country? National citizens residing abroad?

## **CHAPTER IX – COMPETITION**

*Preamble: You may wish to include some of these topics in the Statutes*

National federation – organized competitions. Which? how held? who is eligible to take part, etc?

What other competitions are allowed? How controlled/licenced?

Template of Statutes – FIE member country

**CHAPTER X – ETHICAL CODE AND SAFEGUARDING POLICY**

Agree to abide by principles laid out in Chapters XII and XIII of FIE Statutes

**RAPPORT DE LA COMMISSION MEDICALE DE LA FIE  
FIE MEDICAL COMMISSION REPORT  
INFORME DE LA COMISIÓN MEDICA DE LA FIE**

<p><b>Date, lieu et heure de la réunion :</b>  <b>Date, place and time of the meeting:</b>  <b>Fecha, lugar y horario de la reunión:</b></p>	<p><b>July 7<sup>th</sup> - 8<sup>th</sup>, 2023</b>  <b>Zoom Meeting 1pm – 4pm CET</b></p>
<p><b>Participants:</b>  <b>Participants:</b>  <b>Participantes:</b></p>	<ol style="list-style-type: none"> <li>1. AZE, Erika – Executive Committee Representative</li> <li>2. HAZEM, Abed</li> <li>3. FERJANI, Jameleddine</li> <li>4. FIORE, Antonio</li> <li>5. HALAIMA, Sabrina Imene</li> <li>6. KAMUTI, Jeno</li> <li>7. SUMMERS, Jeremy – Medical Commission President</li> <li>8. HUZEL, Lisa</li> <li>9. MAKSIMOVA, Anastasiia</li> <li>10. MUSTAFA MOURAD, Maha</li> <li>11. SHAFAT, Davood Reza</li> </ol>
<p><b>Absences (indiquer si l’absence avait été annoncée) :</b>  <b>Absent (indicate if the absence had been announced):</b>  <b>Ausencias (indicar si la ausencia fue anunciada):</b></p>	<ol style="list-style-type: none"> <li>1. None</li> </ol>

**INTRODUCTION  
INTRODUCTION  
INTRODUCCIÓN**

This Medical Commission Report reflects the proposals, agenda items, and diverse viewpoints presented at the July 7<sup>th</sup> & 8<sup>th</sup>, 2023, Medical Commission meeting.

***ATTENTION: this record version does not address the discussion or viewpoints of the Medical Commission regarding 2023 Proposals. Please see our entire meeting notes and minutes version to include our opinions and discussion on the 2023 proposals.***

All Medical Commission members were present and participated in each FIE Congress proposal and scheduled agenda items.

Each Medical Commission member has been encouraged to review this document to ensure accurate representation. This report is a testament to the Commission’s commitment to athletes' health, safety, and the advancement of sports medicine. Comments and queries are encouraged from any FIE Commission, Council, or national federation representative. Please contact the president of the Medical Commission.

**RAPPORT DE LA RÉUNION  
MEETING REPORT  
INFORME DE LA REUNIÓN**

**Point 1 / Item1 / Punto 1:**

Items 1 – 4 Proposals from Commissions and Councils for the 2023 Congress  
Modifications of the Organisation Rules

**Point 1-5 / Item 1-4 / Punto 1-4:**

Proposals – P.3, P.4, P.7, P.24, P.34

Discussion, minute notes, and medical commission opinion not included for the following proposals in this version of our meeting report. For the entire Medical Commission Report - Please contact President of the Medical Commission at summersjss@gmail.com.

**Point 6 / Item 6 / Punto 6:**

**Item 5 – World Championships Assignments and Olympic Games Paris 2024**

Unanimous decision for Medical Commission selection of Dr. Jeremy Summers and Dr. Sabrina Halaimia for Paris 2024 Olympic Games. Below are the Medical Scheduling Assignments for 2024-2025 Season (\*Antidoping – AD)

Event	Dele. 1	Dele. 2	Dele. 3	AD 1	AD 2	Alternate
Paris 2024 27/7/24	Summers	Haalaim	N/A	N/A	N/A	Ferjani Maksimova
Jr/Cadet Riyadh 12/4/24	Hazem	Huzel	Shafaat	Ferjani	Maksimova	Halaima
Veterans - TBD 10/1/24	Mourad	Hazem	N/A	N/A	N/A	Summers

**Item 7 (Part I) – IOC / LA2028 Report & COMEX Proposal for Implementation of Injury Surveillance**

– Created and presented by Dr. Jeremy Summers

**Review of IOC / LA2028 Report on FIE Sports Injury Data** – below are key highlights of information from the Medical Commission report that must be addressed in the immediate future. Additionally, it must be stated that Professor Peter Harmer, PhD, ATC, FACSM was contracted to complete this request from the IOC / LA2028 due to his 16+ years of service and experience in collecting FIE Injury epidemiology data and as the pioneer and developer of the initial FIE Injury Surveillance system. The information below will outline deficiencies in our current system and support our proposal for a unified and updated FIE Injury and Illness Surveillance system that can be sustained even with changes in FIE Medical Delegates as well as become in compliance with the 2020 IOC Recommendations for International Federations of Sport to implement best practices on Sports

Injury and Illness Surveillance System to ensure the health and safety of our athletes in the sport of fencing.

**Background:** In order for the FIE Medical Commission to collect sports injury and illness data for the FIE it first must review all supervisor reports submitted following competition. Currently there is an average of 120 FIE competitions annually. These reports are online for the Medical Commission to access, however, providing supervisor reports online is helpful but only if they are available/accessible and complete. For this request we only analyzed senior events. Below there are key highlights from the report that are important for this meeting and the FIE injury surveillance proposal.

### 1. IOC / LA2028 Questionnaire and Data Request:

- Across the 3 years of current analysis ('18-'19, '19-'20, '21-'22: Senior World Cups and GP only), a total of 40 supervisor reports were missing.
- The reports that are available are only useful to the FIE Medical Commission if the supervisor provides accurate information, meaning that the data from our investigation in injury surveillance shows that the majority of injuries were not reported by FIE supervisors and that supervisor's quality of injury reporting has consistently decreased its reporting of injury of 10% each year from the '18-'19 – '21-'22' seasons.
  - '21-'22 season = only 6 of 29 injuries are reported - approximately 21% of injuries were reported in the '21-'22 season.
  - '19-'20 season = only 5 of 16 injuries are reported - approximately 31% of injuries were reported in the '19-'20 season.
  - '18-'19 season = only 12 of 30 injuries are reported - 40% of injuries were reported in the '18-'19 season.
- A common explanation to underreporting is that supervisors are not medical specialists but FIE supervisors do not need to be specialists in medical issues; however, they must ensure that local medical staff understand their duties of documentation during the competition and that all medical withdrawals from competition must be accompanied with an FIE Medical Withdrawal form with all relevant medical reporting data filled in and submitted in their final reports.
  - All medical information from the competition will be documented by the local medical team and assigned FIE Medical Delegates at major events. The DT and supervisor should ensure that they collected sport injury and illness data which includes but not limited to all medical withdrawals from competition.
- *This is a critical breakdown in the system that the FIE must emphasize to competition organizers and local medical staff.*

### 2. Bolster the FIE supervisor system:

- 2.1. **Step One:** if an athlete must withdraw from a bout for a medical reason, the referee makes a note to the DT to help ensure step two.
- 2.2. **Step Two:** The DT collects the medical report from the event medical team (i.e. – local medical team should athlete name, country, diagnosis, and contact information with the FIE Medical Withdrawal Form).
- 2.3. **Step Three:** Supervisor includes all medical information including injury/illness withdrawals in their final supervisor report.

- 2.4. **Step Four:** Supervisor reports accessible for the Medical Commission to follow up with athletes to fill specific sports injury surveillance criteria as described in the IOC Consensus. Specific diagnosis, mechanism of injury, time-loss etc.
- 2.5. **Step Five:** Medical Commission compiles data sets for each season based upon gender, age category, right-left handed, injury location, injury tissue type and categorization.
- 2.6. **Step Six:** FIE Medical Commission inputs athlete injuries into a database for surveillance and monitoring.
- 2.7. **Step Seven:** FIE Medical Commission drafts yearly and quadrennial reports.
- 2.8. **Step Eight:** Strongly consider a FIE Supervisor minimum competency examination or license, experience/grading system, and/or penalty for non-compliance and poor reporting duties for event supervision. Below are examples of sports that provide examples of a similar process into their supervisor competencies.
  - 2.8.1. **FIBA:** Commissioners, who supervise games, must maintain their license by passing a written exam and attending a clinic every four years. They are categorized into Zonal, National, and Licensed based on their experience and performance.
  - 2.8.2. **FIG:** "Supervisors" that oversee competitions progress through several certification categories from national to international levels. Higher categories necessitate passing written and practical exams along with experience in lower categories.
  - 2.8.3. **World Athletics:** Technical Delegates, the top authority at a competition, must attend seminars and pass written exams to maintain their certification.
  - 2.8.4. **UCI:** Commissaires, who oversee competitions, follow a structured training program that involves progressing through national, continental, and international levels and passing exams at each stage.
  - 2.8.5. **FIFA:** Match Commissioners, akin to supervisors, oversee entire match operations. They reach this level through rigorous training and examination processes.

### 3. Solutions/Recommendations:

- 3.1. Bolster and fix the FIE Supervisor reporting system to ensure quality reporting.
- 3.2. The report recommends requiring event management software developers to include a code that indicates medical withdrawals as opposed to not showing up or not finishing the competition. Currently, both of these situations are classified as 9999. This adds considerable difficulty to the task of evaluating injury risk because potentially every who misses a competition could be counted as a withdraw for injury. This proposal was initially made more than 15 years ago but not acted on by the Executive Committee or SEMI.
- 3.3. COMEX approval of an updated and sustainable FIE Injury & Illness Surveillance System Proposed by the Medical Commission - obtain sports injury and illness platform to become in full compliance with IOC Recommendations.
- 3.4. Consider contracting Professor Harmer as a consultant to transition and assist FIE Medical Delegates for the season of 22'-23' and 23'-24'to help initiate changes in how the FIE collects and manages medical data. Additionally, this will establish a commitment to adhering to the IOC Recommendations for the future.

### Item 7 (Part 2) upcoming COMEX Proposal for Implementation of Injury Surveillance –

Created and presented by Dr. Jeremy Summers

**2023 FIE Medical Commission (SIIS) Proposal** – awaiting final edits and approval from medical commission for COMEX submission.

**Establishing the FIE Injury Surveillance and Intervention System (SIIS): “A Long-Term Strategic Initiative for Enhancing Athlete Health and Safety in Fencing”**

#### Executive Summary

The Fédération Internationale d'Escrime (FIE) is acutely aware of the importance of injury and illness surveillance in the world of sport. In a concerted effort to protect the health of athletes, the Medical Commission has identified the need for well-structured injury surveillance programs, precise data collection, and careful data analyses. This comes as an evolution of over a decade's worth of recommendations and advancements in sports epidemiology, pushing our focus towards overuse injuries and illness in athletes.

Following the request from the IOC and LA 2028 for comprehensive injury and illness data subsequent to the Tokyo 2021 Olympic Games, the FIE Medical Commission has worked relentlessly to provide accurate information, despite the drawbacks of our current methods. A thorough examination of 128 supervisor reports, 168+ international senior competitions and more than 15,000 bouts underscores an urgent need for systemic improvements, particularly as a substantial number of injuries went unreported across three seasons.

Our study also exposed limitations in our current fencing event management software, which fails to distinguish between medical withdrawals, no-shows, and non-completions, leading to potential misclassifications and clouding our understanding of injury rates.

In light of these findings, the Medical Commission proposes the implementation of the FIE Injury Surveillance and Intervention System (SIIS). In alignment with the 'IOC Consensus Statement: Methods for Recording and Reporting Data on Injury and Illness in Sports 2020,' the SIIS is designed to provide a consistent, standardized method for capturing and analyzing fencing-specific injury and illness data.

Our proposal appreciates fencing's unique characteristics by incorporating bout exposure metrics similar to those used in other sports, which could include time spent, number of 5-touch and 15-touch bouts, as well as touches scored and received.

Examining examples from IF like FIFA, FINA, IAAF, and the IOC, our proposal extends the 2020 IOC Consensus Statement principles to meet fencing's specific requirements. This method will empower researchers with accurate tools for analyzing and comparing injury and illness incidence, fostering a broader understanding both within fencing and across other sports.

With the introduction of SIIS, our objective extends beyond enhancing fencing's safety. We also aim to increase its appeal, contributing to a more diverse sporting environment.

In conclusion, SIIS is designed to provide a comprehensive, reliable, and fencing-focused surveillance system, emphasizing the health benefits of fencing, and contributing to a standardized approach to injury and illness surveillance across different sports. Our ultimate goal is to foster a safer, more engaging, and healthier sports environment globally, thereby promoting the broader appeal of fencing.

**Project Background and Motivation:** At the request of the International Olympic Committee and the 2028 Los Angeles Olympic Games' organizers, the Fédération Internationale d'Escrime (FIE) Medical Commission, with crucial support from Professor Peter Harmer, conducted an in-depth review of injury and illness data from international events from 2018 to 2022. The study's primary purpose was to gain critical insights into athletes' health and safety, recognize patterns and potential areas for improvement, and better inform the upcoming 2028 Olympic Games' preparations.

However, during this study, two significant issues were identified. First, the traditional pen-and-paper reporting system, reliant on the completeness and accuracy of FIE supervisors' data, was found to be challenging. Second, an alarmingly low injury reporting rate was found across the seasons under review, indicative of widespread underreporting. For instance, only 20.7% and 31.25% of injuries were reported in the 2021-2022 and 2019-2020 seasons, respectively.

The current event management software also fails to distinguish between athletes who medically withdraw and those who do not appear or complete competitions, affecting the ability to accurately determine injury risk and incidence rates.

Recognizing these issues, the Medical Commission has proposed the creation of the FIE Injury Surveillance Programme, in line with the IOC's 2020 Consensus Statement recommendations, to ensure better health monitoring and safety for athletes.

### 4-Step Project Process

1. **Step One:** System Implementation and Data Collection - The project involves setting up a sustainable Sports Injury and Illness Surveillance System (SIIS), which includes a dedicated database platform to collect, store, and analyze detailed injury and illness data from all FIE events. Members of the FIE Medical Commission will oversee the data collection, ensuring it's thorough and accurate.
  - 1.1. Before each competition, a communication strategy will be implemented to remind all Director Technique (DT) and FIE supervisors of their data collection responsibilities.
  - 1.2. They will be given detailed documents to hand to the local medical team, covering all medical contacts and withdrawals.
  - 1.3. After each competition, they are expected to compile all medical data, include it in their supervisor reports, and email it to the designated Medical Commission delegate and president for that event.
  - 1.4. Proposed solutions to address the identified issues, the FIE Medical Commission is recommending mandating event management software developers **create a specific code that distinctly identifies medical withdrawals, thereby improving data accuracy.** The SIIS



will introduce standardized definitions and classifications for health problems, injuries, and illnesses. This request has been discussed and repeatedly mentioned from over the following years June '09; September '10; July '11; July '13, and July '23.

- 1.5. The system will also include a comprehensive database to systematically record and analyze data, track key metrics, and provide insights into preventive measures and improved athlete care.

### 2. Step 2: Project Deliverables align with IOC 2020 Recommendations

- 2.1. The SIIS will provide a clear and uniform definition of health issues, injuries, and illnesses, precise athlete exposure tracking, injury and illness classification using OSIICS coding system, a comprehensive database for pattern analysis, systematic risk assessment, and the ability to compare data across demographic groups and sport categories.

### 3. Step 3: Resource Allocation The project

- 3.1. Will extend over ten years.
- 3.2. Will rely on access to medical records, collaboration with the Medical Commission and external professionals.
- 3.3. A software platform (FITSTATS) costing \$3,500 annually for ten Medical Commission members, and the cooperation of the athletes for providing necessary data.

### 4. Step 4: Conclusion and IRB Approved Research Project

- 4.1. The SIIS, a ten-year prospective study approved by an Institutional Review Board (IRB), is designed to enhance the welfare and performance of athletes within the FIE. The system will provide comprehensive and data-driven insights into the prevalence, causes, and impacts of sport-related injuries and illnesses in fencing, guiding the creation of preventive measures and improvements in the sport's quality.
- 4.2. The project's objective is to develop, test, and implement an injury surveillance system for international fencing competitions.
- 4.3. The methods will align with the IOC's Athlete Monitoring OCSIIS and SMDCS protocols. The study population will include participants in all FIE-sanctioned international events across the 2022-2032 seasons.
- 4.4. Although the observational study may not provide direct benefits to participants, it poses no foreseeable risks. The data collected will be kept confidential, stored securely, and reported in aggregate form.

**Item 8 – Concussion in Fencing Data Review and Proposal** – Proposal created and presented by Dr. Jeremy Summers.

Meeting discussion: General agreement of updating the FIE Medical Handbook – working group created.

**Proposal within Medical Commission:** We agree that editing the FIE Medical Handbook to include comprehensive protocols for concussion and cervical spine injuries, encompassing the identification, prevention, and management of these injuries during FIE competitions. A dedicated working group, led by Dr. Summers, Dr. Halaimia, and Dr. Huzel, is proposed to guide this essential revision process.

**Motivation:** As the international governing body for fencing, the FIE must continually prioritize the health and safety of its athletes worldwide. Initial documentation of concussion in fencing was recorded in July '14 with discussion of the risk of concussion in fencing and regulations related to evaluation. Harmer (AUS) indicated that his research shows that the risk of concussion in fencing is very low (approximately 1 time in 74,000 bouts). However, the Medical Commission will consider a concussion protocol for future use". This injury type has resurfaced the need for updating protocols with recent epidemiological research within USA fencing (2015-2020) with robust system of protocols and documentation underscores the pressing need for an inclusive revision of the FIE Medical Handbook, reflecting our commitment to remain aligned with emerging findings on athlete safety.

The retrospective analysis conducted by USA Fencing presented crucial insights into mild traumatic brain injuries, or concussions, in fencing. This investigation, which spanned five competitive seasons and involved 98,000 competitors, yielded a concussion rate of 0.144 per 1,000 athlete exposures. These figures may offer some insight into potential injury rates at the FIE level, given its oversight of an estimated 100,000 to 150,000 bouts per season. Using this analysis as a loose guideline, one might anticipate between 14 to 22 potential concussions annually within FIE competitions. It is important to note that even though this projected incidence is lower than in contact sports, it serves as a sobering reminder of the risks in fencing, which could lead to serious long-term health implications for fencing athletes.

Further concerns arise regarding the potential underreporting, mismanagement, or overlooked concussions within our fencing community. These concerns mandate a rigorous re-evaluation and strengthening of the current concussion management strategies of the FIE.

The risk profile in fencing extends beyond concussions to encompass potential cervical spine injuries due to sudden head movements or falls. Consequently, it's crucial that we also integrate prevention and management protocols for cervical spine injuries into the FIE Medical Handbook.

In addition, specific guidelines for the safe removal of fencing masks following a suspected injury must be established to avoid exacerbating potential head or neck injuries. This initiative must take into account the unique constraints of fencing gear to ensure immediate, safe access to injured athletes.

### **Proposal motivation:**

1. Inclusion of recent epidemiological data: The FIE Medical Commission handbook should incorporate current research and understanding of concussion and cervical spine injuries in fencing, reflecting the latest scientific findings.
2. Enhanced athlete and staff education: The Medical Commission aims to provide essential knowledge on injury risks, recognition, and management to athletes, coaches, referees, and medical teams, facilitating a swift, effective response at FIE-sanctioned events.
3. Development of safety protocols: We need practical guidelines for fencing mask removal in the event of an injury, ensuring athlete safety during emergency responses.

By enacting these proposed changes, the Medical Commission upholds its commitment to athlete safety, sporting integrity, and the enduring appeal of fencing. By strengthening safety protocols and fostering an environment that prioritizes athlete well-being, we enhance the safety of our sport and contribute to a healthier, safer fencing environment globally.

### Review of head injury data in fencing –

#### 2021 IOC World Conference on Prevention of Injury and Illness Conference, Monaco

**A Retrospective Analysis on the Epidemiology of Concussions within USA Fencing (2015–2020): Prevention, Care, & Return to Play Considerations.** Authors: Adam J. Thompson, PhD, LAT, ATC<sup>1</sup>, Jeremy S. Summers, DC, DACBSP, LAc, ATC<sup>2</sup>, Alan D. Freedman, MEd, LAT, ATC<sup>3</sup> Affiliations: <sup>1</sup>Division of Health and Human Performance, Indiana Wesleyan University, Marion, IN, USA; <sup>2</sup>USA Fencing, Colorado Springs, CO, USA; <sup>3</sup>Department of Allied Health, University of Illinois Springfield, Springfield, IL, USA

#### Abstract

- **Background:** Mild Traumatic Brain Injuries (mTBI) or concussions pose significant public health risks, affecting athletes across a spectrum of sports. Despite fencing's classification as a non-contact sport, concussions can occur due to rapid head movements or incidental contact with an opponent's weapon.
- **Study Design:** This research is a retrospective analysis of data collected over five competitive seasons (2015-2020) from the Sport Event Medical Encounter System (SEMES) at USA Fencing sponsored domestic events and international involvements.
- **Methods:** Data encompassing all fencing categories from youth to veteran competitors were analyzed, focusing on the incidence and prevalence of concussion, identified as indirect head trauma from an opponent's weapon guard or direct posterior trauma from falling.
- **Results:** Among 98,000 competitors, there were 70 head injuries requiring medical intervention, leading to 49 withdrawals from competition due to concussion evaluation. The concussion rate was calculated at 0.144 per 1,000 athlete-exposures. Male fencers and saber users showed a higher predisposition, with a median age at diagnosis of 20.7 years.
- **Conclusion:** Despite the relatively low incidence of concussion in fencing, it's crucial to acknowledge each injury's potential significant implications. The lower concussion rate should not lead to complacency but should promote enhanced education, robust concussion guidelines, and a commitment to athlete safety.

#### Proposal Summary:

- In the context of this study, "AE" stands for "athlete-exposures as in-competition bout exposures," which is a term used in sports medicine to measure the number of times an athlete participates in a sports activity where they are exposed to the potential of an injury. In this case, each bout, or match, an athlete participates in counts as one "athlete-exposure."
- The study found that there were 0.144 concussions per 1,000 athlete-exposures. To translate this into a larger, perhaps easier to understand figure: this rate equates to approximately 1.44 concussions for every 10,000 bouts fenced. This means that for every 10,000 bouts played,

around 1 to 2 fencers experienced a concussion. It's important to note that this is an average, so the actual number can vary.

### Item 9 - Liaison Check-ins with other commissions and councils

Liaison Appointments and Updates:

- (1) SEMI – (no individual) – Hazem is assigned as Medical Commission liaison to SEMI Commission.
- (2) Update - WADA Antidoping & Education (Summers/Halaima) – FIE policy was updated with Nathalie Rodriguez/Summers. We completed educational program Jr/Cadet 20-30 individuals – Sr. was 15 participants. Halaimia: This format may not reach enough people and needs to be reexamined additionally the cost of ITA support and educational support for Medical Commission support.
- (3) Safeguarding (Fiore, Huzel) – no update. Safeguarding reporting refresher 2023-2024.
- (4) Environmental (Mourad) –
  - (a) April 2<sup>nd</sup> Environmental Day – date set for FIE community awareness.
  - (b) Halsted/Mourad – Approval of proposal
  - (c) Plovdiv 2023 – foresting event (planting trees) went great and was well received.
  - (d) Every event has something to contribute, building awareness. Meeting with fencing manufactures also was very productive.
  - (e) Athlete Ambassadors – created by the FIE
- (5) Handbooks – (Rodriguez, Summers) – no update. Will provide proposal approval for concussion handbook update in 2024.

### Item 11 – IOC Framework on Inclusion, Fairness, and Safety

- Invite Georgina Usher/Summers – on an update.
- Joint meeting with Women and Fencing Council went extremely well. Usher and Dr. Summers gave a summary update on current practices and protocols within international sport federations and listed four common options and practices to balance inclusion and fairness in sport.
  - Timeline for proposal to FIE COMEX will be determined by the working group but is tentatively planned before the end of 2023. Key stakeholders will be approached for inclusion into the working group and/or our recommendations will be sent to Legal Commission, Athlete Commission, and Coaches Council for feedback and approval.
  - Working Group – Jeremy Summers, Georgina Usher, Antonio Fiore, Sabrina Halaimia, Kaitlyn Fox-Reading. Working group will meet bi-monthly to provide proposal to COMEX prior to 2024.

# FIE 2023 Proposals – Medical Commission

July 17<sup>th</sup>, 2023 – FIE Medical Commission Meeting July 7<sup>th</sup> and 8<sup>th</sup>, 2023

## **Article: 4.4.2 Proposal from: Legal Commission – P.3**

### **Executive Summary: Medical Commission Vote: 8 NO – 2 YES – rejection of the proposal**

The core issue of discussion pertains to the expansion of criteria for Medical Commission Member candidates to include Doctors of Osteopathy (DO) and Doctors of Chiropractic (DC) proposed by the Legal Commission. While the proposal was rejected by the majority of the Medical Commission with a vote of 8-2, the dissenting and advocacy votes raised significant points that merit further consideration.

### **Primary Arguments Against the Proposal:**

1. **Certification Requirements:** Critics stress the importance of having individuals with the highest level of certification recognized in conventional medicine in their respective countries on the Medical Commission (MC), due to the potential of unforeseen medical emergencies at fencing competitions.
2. **Standardization of Training:** Critics of the legal proposal underscore the worldwide variances in training and recognition between MDs and other healthcare practitioners. They argue that MD training enjoys a more globally standardized model compared to that of DOs or DCs, who lack authorization to practice medicine in several countries. The consensus is that medical decisions for events ought to be made by a medical doctor, whether they are a medical delegate or an assigned event medical doctor.
3. **Liability Concerns:** The potential liability of the FIE in a situation where an MC representative who is not a licensed physician has to handle a medical emergency is a central concern. Critics argue a non-physician MC delegate might not be equipped to recognize medical malpractice or incompetence.
4. **Relying on Local Medical Expertise:** There are concerns about over-reliance on local medical expertise during FIE events. Critics advocate for maintaining a high standard of medical licensing and competence among its MC delegates, rather than delegating and/or potential issues in relying on only with responsibilities to local organizers.

### **Key Advocacy for the Proposal:**

1. **Delegate Duties:** Supporters argue that the FIE medical delegates' role does not involve practicing medicine but rather identifying and managing health issues, therefore negating the necessity for an MD qualification only but rather with qualified and licensed sports medicine healthcare professionals.
2. **IOC Requirements and Safety Considerations:** Advocates reference the IOC Medical Code (1.6.2), asserting that all healthcare providers must have relevant sports medicine training, education, and experience. They argue this ensures that qualified professionals, irrespective of their designation, can provide competent care.

## FIE 2023 Proposals – Medical Commission

3. **Recognition of Other Healthcare Degrees:** Advocates of the proposal acknowledge the global disparities in educational standards and the legalization of practice. Even so, they highlight that many countries uphold rigorous international standards for education and licensure. It would be unfair, from their standpoint, to exclude individuals such as Doctors of Osteopathy (DOs), Doctors of Chiropractic (DCs), and physiotherapists who meet these stringent qualifications from candidacy for the Medical Commission. They contend that these professionals, having attained an internationally standardized education, are fully equipped to assess athletes effectively and cooperate with local medical teams as necessary. This perspective aligns with the stipulations of the FIE rules and the responsibilities of a Medical Commission member. Supporters advocate for the inclusion and recognition of DOs, DCs, and physiotherapists, insisting that these professionals can proficiently fulfill the duties set forth by the FIE and the Medical Commission.
4. **Relying on Local Medical Expertise:** The argument proposed by the opposition with the medical commission, voicing concerns about reliance on local medical expertise at all FIE events, inadvertently overlooks the substantial 97.5% of events not attended by Medical Commission delegates. If their assertion - the supposed inadequacy of local medical teams - holds, it implies a larger, systemic issue requiring immediate attention across all FIE events, not just the major ones. This viewpoint carries significant implications, as it seems to suggest that only major events warrant attendance by a medical commission member as a MD only, thereby sidelining the 97.5% majority of FIE events. However, this argument is presented without any data or empirical evidence demonstrating the local medical staff's ill-preparedness, leaving it as a potentially unsubstantiated claim. Moreover, it's concerning that the proposition underscores the need for medical commission members as MDs only to be present only at major events, rather than addressing the alleged deficiency of local medical coverage at all FIE events. This discrepancy reveals a possible flaw in the argument and questions the actual intention behind this point. If the assertion about local medical teams' competence were indeed factual, the correct approach would involve providing comprehensive solutions to enhance the medical coverage across all FIE events rather than focusing in on the 2.5% of major events that FIE Medical Delegates are assigned too. The focus should shift from being centered only MDs at major events to ensuring optimal medical care during all FIE-sanctioned competitions licensed and trained healthcare providers in the specialty of sports medicine, thus truly prioritizing athlete safety. We must collaborate and rely on the local organizers event medical staff for the implementation of emergency procedures.
5. **Diverse Skills and Competencies:** Supporters stress the diverse competencies that professionals other than MDs can bring to the MC, cautioning against focusing solely on a delegate's degree which might overlook a range of relevant expertise that could benefit the FIE and serve the complexities within sports medicine umbrella of expertise.
6. **Historical Contributions:** Supporters point to the historical contributions of non-MDs, such as Peter A. Harmer's 17-year service and significant work for the sport of fencing and the FIE Medical Commission and his work on Fencing Sports Injury Epidemiology.

## FIE 2023 Proposals – Medical Commission

7. **Expert Opinions:** Prominent figures like Richard Budgett, IOC Medical Director, and Roald Bahr, a leading expert in sports medicine, corroborate that the IOC does not mandate specific professional qualifications for the international Medical Commission delegates or events as MDs only, but leaves it to the IF's discretion. They elucidate that non-MDs can fulfill their roles, except ordering tests or prescribing, even if they're not in a clinical role.

### **Article: o.18 – P.4 Proposal from: Women and Fencing Council**

Medical Commission vote: 9/10 in support of the proposal - with one decent - In principle, I agree, but cannot be a rule. It can make a lot of problems with scheduling.

### **Article: o.16, o.18, o.26, o.29, o.39, o.50, o.63, o.75, o.103, o.104 – P.7**

#### **Proposal from: Rules Commission**

**Motivation:** Creation of new Veterans chapters.

Medical Commission vote 10/10 support of the proposal – all 10/10 medical commission members

### **Article: t.45**

#### **Proposal from: Rules Commission P.24**

#### **Executive Summary:**

The Rules Commission has proposed an amendment to Article: t.45 to reduce the duration of a medical timeout from five minutes to three, based on the belief that the existing rule is occasionally or often misused by athletes for strategic advantage. They suggest trialing this rule change at the 2024 Junior and Cadet World Championship in Saudi Arabia.

While the Medical Commission recognizes the need to prevent misuse of medical timeouts, the proposal was unanimously rejected due to the lack of empirical evidence supporting the claim of misuse and potential compromise on athlete health due to reduced time for medical evaluation and treatment. Additionally, the proposed three-minute medical intervention period may not offer sufficient flexibility to manage diverse medical situations effectively.

The Commission acknowledges the need for an evidence-based approach to such decisions. To this end, there is significant potential to collect and analyze data across FIE events. Recording and examining crucial data points—such as strip calls, medical timeouts (awarded and denied), quick interventions, time taken to award a timeout/medical assessment and intervention/treatment duration, athlete's country, handedness, and bout score at injury time and which opponent was down in correlation to injury request—can create a substantial evidence base.

# FIE 2023 Proposals – Medical Commission

This approach aligns with the IOC Consensus Statement of 2020 and provides crucial epidemiological insights into sport-specific injuries. It also offers an excellent opportunity to improve the quality of medical coverage at over 97.5% of international events through targeted training for local organizers and healthcare professionals. This strategy could encompass a brief 10-15 minute educational presentation and a subsequent quiz, enhancing adherence to FIE competition rules and reducing medical assessment and treatment times.

In conclusion, while the motivation behind the proposed amendment to Rule t.45 is understood, it requires comprehensive, empirical data to underpin any modifications. The Commission believes that capturing and analyzing pertinent data from FIE events, and bridging educational gaps among local organizers and medical staff, will serve the interests of athlete health, ensure fairness, and improve the effectiveness of the rules across all competitions. Such an ambitious proposal has a strong endorsement from the Medical Commission and would be interested in a joint proposal to the executive committee to improve the healthcare quality of and running of international events.

***Please see entire discussion below.***

**Proposal Overview:** The Rules Commission has put forth a proposal to curtail the duration of a medical timeout from five minutes to three. The proponents of this amendment argue that the current regulation allows athletes to misuse this duration as a strategic advantage in challenging situations or when lagging behind in scores. The proposal suggests implementing this rule change as a trial during the 2024 Junior and Cadet World Championship in Saudi Arabia.

## **Detailed Analysis:**

1. **Assertion of Misuse:** The proposal initiates its argument by suggesting that athletes frequently manipulate the five-minute medical timeout as a strategic maneuver when they face physical strain or score deficits. While the Medical Commission delegates take such a claim with utmost seriousness, it's important to note that it lacks the substantiation of empirical evidence or statistical data. The argument principally leans on the subjective observations of referees, whose views we respect, but the absence of quantitative evidence weakens the robustness of the claim.
2. **Emphasis on Athlete Health:** The proposal underscores the primacy of athlete health and proclaims that in case of a significant injury, the athlete should discontinue the competition. The juxtaposition of this assertion with the objective of reducing the medical timeout is somewhat contradictory. If the wellbeing of the athlete is indeed the focus, curtailing the timeframe allocated for medical professionals to assess and treat an injury seems counterproductive.
3. **Proposal of a Three-minute Medical Intervention:** The proposition implies that a duration of three minutes should suffice for a medical professional to evaluate an athlete's condition, establish a diagnosis, and determine whether they can continue with the competition. This implication raises concerns, as it fails to account for the wide



## FIE 2023 Proposals – Medical Commission

range of potential injuries and their varying degrees of severity. Implementing a blanket three-minute timeframe may not provide sufficient flexibility to effectively address all potential medical situations.

4. **Proposed Amendments to Rule t.45:** The modifications suggested in the written rule t.45 are logically consistent with the motivations outlined in the proposal. However, they also carry the inherent weaknesses present in the proposal, predominantly the lack of empirical support and potential contradiction with athlete health prioritization.
5. **Reactions from the Medical Commission:** The proposal was unanimously rejected by the Medical Commission members, citing a variety of concerns such as the absence of data substantiating the request, complexities in juxtaposing fencing with other sports, and potential interruptions to the medical evaluation and treatment process.

In conclusion, while the Rules Commission's proposal to reduce the medical timeout from five minutes to three is founded on well-intended concerns, it is critically important that any modifications to such rules be thoroughly grounded in comprehensive, empirical evidence. Given that over 2.5% of the FIE events have assigned Medical Commission delegates deeply familiar with rule t.45 and its implementation, we are presented with an exceptional opportunity to collect and analyze pertinent data across all FIE events. Currently, all medical timeouts must be documented on pool sheets or bout sheets, but the utilization of this data remains unclear. By developing systems to capture injury data, diagnosis times, and treatment durations, we can gather substantial evidence that could aid in justifying a rule change, if needed. Furthermore, this data could equip the Medical Commission with valuable insights into sport-specific injury epidemiology, aligning with the IOC Consensus Statement of 2020. The Medical Commission would likely endorse a proposal with such ambition, as it fundamentally serves the interest of athlete health and safety while ensuring the rules are applied fairly and effectively across all competitions.

**Article: t.109 - p.33**

**Proposal from: Women and Fencing Council**

Medical Commission Vote 10/10 in support of the proposal

**Article: t.111 – P.34**

**Proposal from: Women and Fencing Council**

Medical Commission Vote – 10/10 in support of proposal

**Minutes of the meeting of the PCM Commission  
Online Zoom Meeting June 7<sup>th</sup> & 8<sup>th</sup>**

**Meeting of the FIE Promotion, Communication and Marketing Commission**

**Online Zoom Meeting**

**Date: June 7<sup>th</sup> & 8<sup>th</sup>**

**Attendees:**

- Nikolay Mateev
- Carl Borack
- Gulnora Saidova (only 7<sup>th</sup> of June)
- Laura Flessel Colovic (only 7<sup>th</sup> of June)
- Mohamed Sofiane Chaouachi
  
- Barna Héder, FIE Head of Television Production
- Serge Timacheff, FIE Media Manager
- Zhen Ma, FIE Digital Communication Manager

**Absent:**

- Yuki Ota (Representative of the FIE Executive Committee)
- David Baker
- Jose Luis Abajo Gómez
- Joyce Bolanos
- Shunsuke Saka
- Youssef Fathi

**1. Introduction**

- Nikolay Mateev welcomed members of the Commission to the meeting.
- Presentation and Validation of the Agenda

**2. Meeting with the Women and Fencing Council**

- Discussed how to implement ideas from the Women and Fencing Council
- Discussed promotion strategies:  
Promote discussion and establish goals

- Instagram #fencingtogether => Together we are stronger
- Diversity officer
  - Escrime Media, new web-based magazine
- Serge Timacheff “increasing the collaboration with the Women and Fencing Council is welcome”

### **3. Meeting with the Veteran Council**

- Discussed how to implement ideas from the Commission and the Council
- Proposed ideas to promote Veteran Fencing
- Focus on the Veteran World Championships, to be held in Daytona Beach, USA on October 11-16. Discussed promotion strategies

### **4. Meeting with the SEMI Commission**

- The SEMI commission has approached us to take over responsibility for the publicity code at the World Championships
- We believe that our commission has the capability and capacity to do so
- Present a joint proposal from both commissions to be approved by COMEX

### **5. Presentations from CM&TV department**

We would like to thank Serge, Zhen and Barna for their active participation in our commission meeting. We have received comprehensive information on all matters.

### **6. Roundtable discussions with Serge Timacheff, Zhen Ma and Barna Héder**

#### **FIE Marketing Strategy / FIE Marketing Plan / FIE Sponsorship**

#### **Main Selling Points**

What are the key points that could sell Fencing and the FIE to a potential sponsor?

#### **A Strong History**

- Fencing has been in every modern Olympic Games since 1896.
- Sport dates back hundreds of years but modernized with electric scoring and video replay.

#### **The ideal sport for a cornerstone sponsor**

- A global reach with 155 member countries.
- 12 Medals at stake in the Olympic Games, with gender equality.
- Growing interest in broadcast, commercial and digital. Opportunities with the Olympic Channel.

- High marks by the IOC for the Olympic broadcast coverage.
- Signage opportunities in the competition venue, billboards, posters, and on the website and in the broadcast.

#### **Athletes are already strong brands**

- Many athletes already have strong branding and material external sponsorship (e.g., Max Heinzer, Olga Kharlan).
- Significant regular live content means a lot of brand exposure.

#### **A unique sport**

- Fencing is known to be the fastest martial art or “the elegant martial art”.
- An evolution of duelling, how to settle a dispute or determine a winner in a structured, rules-based environment
- Sportsmanship is a key tenet of our sport

#### **A platform for growth**

- Established in some countries, fencing is both France and Italy’s most successful Olympic sport
- Opportunity for other countries, e.g., Venezuela’s 2nd ever gold medal in London 2012, Estonia’s 4th gold medal since independence won in Tokyo 2020
- A significant growth sport across all age groups, sponsorship opportunities available at Cadet and Junior World Championships and World Cups

#### **A sport for life**

- Growing Veteran sport, with clear physical and cognitive benefits.
- Veteran fencing features highly successful people and an important market to certain sectors e.g., finance, banking, insurance, auto, travel, health, investment.
- This target group is financially strong and increasingly demanding.

#### **Precision**

- Fencing rewards accuracy and skill, good decision making and anticipation, timekeeping

#### **Diversity and Equality**

- Fencing and fencers are on 5 continents
- Everyone is equal behind the mask
- Gender equity (same number of events, equal opportunities for men and women)

#### **Cuts through to popular culture**

- Major film franchises have elements of swordsmanship

#### **Next Steps**

- Review other sports for their current sponsorship
- Collect statistics on broadcasts and social media
- Review broadcasting arrangements, discuss possible new channels
- Assess types of sponsorship, for example branding/naming rights, wearables, media presence, collaboration with influencers
- Assign responsibility for creating marketing materials, central point of contact for sponsorship
- Create a list of potential sponsors, most importantly identify contacts or former fencers with decision making ability to support the FIE sponsorship proposal

- Collaborate with a group of National Federations that can help to look for the sponsors in their countries

#### **FIE Live broadcasts and streaming**

- Understand the advertising strategy.
- What costs are involved in advertising FIE broadcast?
- What advertising revenues could be received from FIE broadcasts?
- Examine the relationship with existing broadcasters, both traditional (Eurosport) and online (Youtube, Facebook, other online streams).
- How can we increase the number of viewers to the streamed and broadcasted events? What can we do to raise awareness of the ability?
- How can we get journalists and broadcasters to view the available videos? How can we give them story ideas for their publications and media?
- What is the consensus on the quality of the announcers of the broadcasts?
- Updated on-screen graphics:

The commission would like to see athlete statistical and biographical data, incorporating and expanding the existing web data.

The track record between 2 fencers, their favorite hits, national and personal trainers, hometown and club, number of penalties, etc.

Short biographical elements could be screened immediately before the start of finals fights, possibly including some footage from a previous bout.

A reference could also come up on screen to show the FIE website and FIE sponsors.

For major events (World Championships and GP) there should always be a Master of Ceremonies (MC), as well as announcers, to inform and entertain the live audience. Particularly important during short breaks and delays. Well explained event is critical – the impressive Orleans Women’s World Cup given as an example.

The commission would like to increase dramatically the attendance, and after the final at the Medal Ceremony. Many different ideas have been tried in the past. Lottery system to be trialed. Include LOC engagement with the community.

#### **What has been done and is being done to promote the World Championship in Milan?**

#### **How does the FIE intend to handle the press with respect to the “neutral” athletes and the politics behind that decision?**

#### **OG Paris 2024**

- With respect to the 2023-24 season, what plans does the staff have towards promoting the Paris Olympic Games? How will publicity and promotion be laid out over the course of the Olympic year? How will the Grand Prix’s be used to promote the athletes ahead of the Games? Likewise, how will the FIE promote the World Cup team battles and the race to quality to compete In Paris? What video materials are being created? Will we use the opportunity at the

Grand Prix's to videotape the athletes and a build a library of interviews that the media can access in Paris or before.

- Is there a calendar with deadlines for the various Paris related projects that need to be accomplished?
- Does CM&TV department have a coherent and defined marketing strategy for Paris 2024? What VIP's do FIE intend to invite?

#### **7. Presentation from Mohamed Sofiane Chaouachi, TUN**

- Out-of-the-box promotion of fencing during the African Beach Games in Hammamet, Tunisia.
- Cultural events during the GP

#### **8. World Fencing Day**

The joint proposal from our commission and CM&TV department is:

**Fencing is for everyone**

Lifelong sport, disciplines across generations: youth, cadet, junior, senior, veteran.

We need to emphasize our universality and to take advantage of our strengths - a lifelong sport, disciplines across generations: youth, cadet, junior, senior, veteran.

On one side we have our historical roots, our place in IOC history in every modern Olympic Games. On the other hand, we need to show how truly global and modern fencing has become.

FENCING IS ---)----- UNIVERSALITY

FENCING IS ---)----- SPORTSMANSHIPS & SOLIDARITY

FENCING IS ---)----- RESPECT & DISCIPLINE

#### **8. Proposals for the Congress**

- See Appendix 1

## **Proposals for the 2023 Congress**

### **Modifications of the Technical Rules**

**P.33**

**Proposal from: Women and Fencing Council**

**Commission opinion: In favor**

**P.34**

**Proposal from: Women and Fencing Council**

**Commission opinion: In favor**

### **Modifications of the Material Rules**

**P.45**

**Proposal from: SEMI Commission**

**Commission opinion: In favor**

### **Modifications of the Statutes**

**P.5**

**Proposal from: Legal Commission**

**Commission opinion: Not In favor**

### **Proposed texts from PCM Commission:**

#### **A candidate for the Promotion, Communication and Marketing Commission must:**

- **have a college or university degree in Marketing, Communications or Media**
- **or have professional experience in Marketing, Communications or Media**
- **or have been a member of the Commission for at least 4 years**

## FIE REFEREEING COMMISSION REPORT

<b>Date, place and time of the meeting:</b>	<b>7 July 2023 online 13.00-18.00</b> <b>8 July 2023 online 13.00-17.00</b>
<b>Participants</b> <b>Refereeing Commission :</b>	Irina Knysch Olga Cojocari Chang Gon Kim Jean-Marc Genuet Marius Florea Khassoum Papa Toure Salah Ferjani Amgad Badawi Vladislav Shamis
FIE Interim President	Emmanuel Katsiadakis

### MEETING REPORT

1. Discussion of all Congress proposals
2. Review proposals of referees received from the National federations
3. Review of referees and modification of the Masterlist 2023-24
4. Appointment of Refereeing Commission delegates for FIE examinations 2023
5. Appointment of Refereeing Commission delegates for World Cups and GP for the season 2023-24
6. Discussion with Women and Fencing Council concerning proposals for the Congress 2023
7. Discussion with Rules Commission their and Refereeing Commission proposals for the Congress 2023
8. Agenda for Milano meeting was finalised
9. Proposal for COMEX concerning per diem and dinner during World Cups and GP for referees and RC delegates





**Proposals for the 2023 Congress**  
**Modifications of the Organisation Rules**

The texts below are applicable on January 1st, 2024, unless mentioned otherwise.

---

**Article:** o.18

P. 4

**Proposal from:** Women and Fencing Council

**Motivation:**

Advance gender equality in refereeing, SEMI and medical delegates, to assist in the development of more females in all roles in fencing and to ensure that both genders have representation.

Demonstrate the FIE's commitment to the IOC objective to advance gender equality in all aspects of Olympic sport and help ensure that the FIE are able to meet the gender representation quotas for participation in the Olympics.

**o.18**

Designation of refereeing, SEMI, and medical delegates

Refereeing delegates must be members of the FIE Refereeing Commission. SEMI delegates must be members of the FIE SEMI Commission.

Medical delegates must be a members of the FIE Medical Commission.

1. World Championships

A chief Refereeing delegate and 5 more Refereeing delegates, a chief SEMI delegate and 2 more SEMI delegates and 3 Medical delegates are appointed by the FIE Executive Committee following the recommendations of the respective commissions. **Across all the delegates there must be at least 30% of Refereeing delegates and at least one of SEMI and medical delegates from each gender.**

2. Grands Prix

Two Refereeing delegates are appointed by the Executive Committee following the recommendation of the Refereeing Commission. **There must be a minimum representation of at least 20% of each gender when all Grand Prix appointments across all weapons are considered together.**

3. Senior World Cup competitions

One Refereeing delegate is appointed by the Executive Committee following the recommendation of the Refereeing Commission. **There must be a minimum representation of at least 20% of each gender when all Senior World Cup appointments across all weapons are considered together.**

4. Veterans World Championships

Two Refereeing delegates, one SEMI delegate and two Medical delegates are appointed by the FIE Executive Committee following the recommendations of the respective commissions. [There must be at least one delegate from each gender within the total of 5 appointments.](#)

**Opinion of the Refereeing Commission: not in favour**

---

**Article:** [o.25.3](#)

**P. 5**

**Proposal from:** [Women and Fencing Council](#)

**Motivation:**

To assist in the FIE gaining better understanding of the numbers of female referees.

**o.25.3**

[3 In addition, the organising committee of junior World Cup competitions and satellite competitions is required to monitor and report on gender diversity of the registered referees.](#)

**Opinion of the Refereeing Commission: not in favour**

---

**Article:** [o.26](#)

**P. 6**

**Proposal from:** [Women and Fencing Council](#)

**Motivation:**

Advance gender equality in refereeing, to assist in the development of more females in all roles in fencing and to ensure that both genders have representation.

Demonstrate the FIE's commitment to the IOC objective to advance gender equality in all aspects of Olympic sport and help ensure that the FIE are able to meet the gender representation quotas for participation in the Olympics.

Where it is not possible to meet minimum expectations then written reports will assist in exploring solutions.

**o.26**

- 1 Refereeing at Veteran World Championships is carried out by referees appointed by the Executive Committee of the FIE, selected by the Refereeing Commission on indication of the Organizing Committee and Veterans Council. [There must be a minimum representation of at least 30% of each gender across all such appointments.](#)  
Referees must attend the refereeing meeting that takes place the day before the World Championships.
- 2 For **Senior World Cup, Grands Prix and World Cup team competitions**, 8 referees, proposed by the Refereeing Commission, will be designated by the Executive Committee and delegations will not have to provide any referees. [There must be a minimum of one person from each gender, if possible. If this is not possible a written explanation must be provided to the FIE.](#)

The additional referees required (not less than 5) will be provided by the organising committee. **All the referees will be at the expense of the organisers who in return will keep the entry fees.** There must be a minimum of one person from each gender, if possible. [If this is not possible a written explanation must be provided to the FIE.](#)

**Opinion of the Refereeing Commission: only o.26.1 in favour**

**o.26.2 not in favour**

---

**Article:** o.16, o.18, o.26, o.29, o.39, o.50, o.63, o.75, o.103, o.104

P. 7

**Proposal from:** Rules Commission

**Motivation:** Creation of new Veterans chapters.

**o.16**

~~3 — Veterans World Championships~~

~~The Directoire Technique is composed of four members of different nationalities, one of whom must represent the country where the competition is held.~~

**o.18**

~~4 — Veterans World Championships~~

~~Two Refereeing delegates, one SEMI delegate and two Medical delegates are appointed by the FIE Executive Committee following the recommendations of the respective commissions.~~

**o.26**

- ~~1. — Refereeing at Veteran World Championships is carried out by referees appointed by the Executive Committee of the FIE, selected by the Refereeing Commission on indication of the Organizing Committee and Veterans Council.~~

~~Referees must attend the refereeing meeting that takes place the day before the World Championships~~

~~2~~

For **Senior World Cup, Grands Prix and World Cup team competitions**, 8 referees, proposed by the Refereeing Commission, will be designated by the Executive Committee and delegations will not have to provide any referees. The additional referees required (not less than 5) will be provided by the organising committee. **All the referees will be at the expense of the organisers who in return will keep the entry fees.**

**o.29**

---

~~6) The age groups in veteran competitions are:~~

~~a) Age group 50-59: Must be at least 50 years old and less than 60 years old in the year of the competition.~~

~~b) Age group 60-69: Must be at least 60 years old and less than 70 years old in the year of the competition.~~

~~c) Age group 70+: Must be at least 70 years old in the year of the competition.~~

---

~~6 — The age groups in veteran competitions are:~~

- a) ~~Age group 40-49: Must be at least 40 years old and less than 50 years old in the year of the competition.~~
- b) ~~Age group 50-59: Must be at least 50 years old and less than 60 years old in the year of the competition.~~
- c) ~~Age group 60-69: Must be at least 60 years old and less than 70 years old in the year of the competition.~~
- d) ~~Age group 70+: Must be at least 70 years old in the year of the competition.~~

~~Application: during the test at the 2025 World Championships (not applicable in 2023 and 2024).~~

---

## **VETERAN WORLD CHAMPIONSHIPS**

### **o.39**

- 1—~~The programme of the Veteran World Fencing Championships comprises twenty-four events, eighteen individual—three categories for each weapon—and six team—male foil, female foil, male epee, female epee, male sabre and female sabre. The programme must be arranged in such a way as to allow any fencer to participate in all weapons. Team events must be held on the day following the last championship of the three categories of each weapon.~~
  - 2—~~No changes of dates are allowed for any competition, after the release of the programme.~~
  - 3—~~Each competition must be held in one single day, avoiding long periods of inactivity.~~
- 

### **o.39**

- 1—~~The programme of the Veteran World Fencing Championships comprises thirty-six events, twenty-four individual—four categories for each weapon—and twelve team—male foil, female foil, male epee, female epee, male sabre and female sabre (two categories for each weapon and gender). The programme must be arranged in such a way as to allow any fencer to participate in all weapons. Team events must be held on the day following the last championship of the corresponding two individual categories of each weapon.~~
- 2—~~No changes of dates are allowed for any competition, after the release of the programme.~~
- 3—~~Each competition must be held in one single day, except for team events for which the round of pools may be achieved the day before direct elimination avoiding long periods of inactivity.~~

~~Application: during the test at the 2025 World Championships (not applicable in 2023 and 2024).~~

---

## **Veterans**

## **o.50**

~~1— Any proposed candidature for organising the Veteran World Championships must be studied at the venue concerned by an ad hoc delegation designated by the Executive Committee, at the invitation of the candidate federation.~~

~~2— The organising committee, who will receive all the entry fees from the participating delegations, must, at their own expense, invite the following international officials (tourist class return air fare, accommodation and daily allowances):~~

~~a) — The President of the FIE or his representative, who presides over the World Championships and, in particular, controls the smooth running of the Directoire Technique.~~

~~b) — Four members of the Directoire Technique appointed by the Executive Committee of the FIE, one of whom must belong to the organising country.~~

~~c) — One member of the SEMI Committee, appointed by the Executive Committee of the FIE.~~

~~d) — One member of the Refereeing Committee, appointed by the Executive Committee of the FIE.~~

~~e) — Two members of the Medical Committee, appointed by the Executive Committee of the FIE.~~

~~f) — The referees appointed by the Executive Committee of the FIE.~~

~~The officials a) to e) should preferably be selected from the Zone in which the Championships are being held.~~

### ***Entries to competitions***

## **o.63**

~~1— Entries must be sent to the organisers by the competitors' national federation. Entries must be sent not later than one month before the beginning of the championships.~~

~~2— However, up to two days before the competition at noon (local time), fencers may be added by their national federation after payment to the Organizing Committee of a penalty equal to 100 % of the registration fee.~~

~~3— Entries for team championships must be forwarded to the Directoire Technique not later than 4.00 pm (local time) of the day before the competition.~~

~~4— At the Veterans World Championships, entries for the individual events are limited to four fencers in each category per gender, per weapon and per nation. The names must be the same as those on the FIE licences.~~

### **Composition of the pools for Veteran individual championships**

## **o.75**

~~The pools are composed taking into account the following orders of strength:~~

~~1. The fencers ranked from the addition of the results in the previous two years Championships, irrespective of age category changes. Scores are awarded according to the following table:~~

~~1st place 80 points~~

~~2nd place 65 points~~

~~3rd place ex aequo 50 points~~

~~5th place 38 points~~

~~6th place 36 points~~

~~7th place 34 points~~

~~8th place 32 points~~

~~9th place 30 points~~

~~31th place 7 points~~

~~32th place 6,5 points~~

~~33th place 6 points~~

~~34th place 5,9 points~~

~~35th place 5,8 points~~

~~36th place 5,7 points~~

~~37th place 5,6 points~~

~~38th place 5,5 points~~

~~61th place 3,2 points~~

~~62th place 3,1 points~~

~~63th place 3 points~~

~~64th place 2,9 points~~

~~65th place 2,8 points~~

~~66th place 2,7 points~~

~~67th place 2,6 points~~

~~68th place 2,5 points~~

<u>10th place 28 points</u>	<u>39th place 5,4 points</u>	<u>69th place 2,4 points</u>
<u>11th place 26 points</u>	<u>40th place 5,3 points</u>	<u>70th place 2,3 points</u>
<u>12th place 24 points</u>	<u>41th place 5,2 points</u>	<u>71th place 2,2 points</u>
<u>13th place 22 points</u>	<u>42th place 5,1 points</u>	<u>72th place 2,1 points</u>
<u>14th place 20 points</u>	<u>43th place 5 points</u>	<u>73th place 2 points</u>
<u>15th place 18 points</u>	<u>44th place 4,9 points</u>	<u>74th place 1,9 points</u>
<u>16th place 16 points</u>	<u>45th place 4,8 points</u>	<u>75th place 1,8 points</u>
<u>17th place 14 points</u>	<u>46th place 4,7 points</u>	<u>76th place 1,7 points</u>
<u>18th place 13,5 points</u>	<u>47th place 4,6 points</u>	<u>77th place 1,6 points</u>
<u>19th place 13 points</u>	<u>48th place 4,5 points</u>	<u>78th place 1,5 points</u>
<u>20th place 12,5 points</u>	<u>49th place 4,4 points</u>	<u>79th place 1,4 points</u>
<u>21th place 12 points</u>	<u>50th place 4,3 points</u>	<u>80th place 1,3 points</u>
<u>22th place 11,5 points</u>	<u>51th place 4,2 points</u>	<u>81th place 1,2 points</u>
<u>23th place 11 points</u>	<u>52th place 4,1 points</u>	<u>82th place 1,1 points</u>
<u>24th place 10,5 points</u>	<u>53th place 4 points</u>	<u>83th place 1 points</u>
<u>25th place 10 points</u>	<u>54th place 3,9 points</u>	<u>84th place 0,9 points</u>
<u>26th place 9,5 points</u>	<u>55th place 3,8 points</u>	<u>85th place 0,8 points</u>
<u>27th place 9 points</u>	<u>56th place 3,7 points</u>	<u>86th place 0,7 points</u>
<u>28th place 8,5 points</u>	<u>57th place 3,6 points</u>	<u>87th place 0,6 points</u>
<u>29th place 8 points</u>	<u>58th place 3,5 points</u>	<u>88th place 0,5 points</u>
<u>30th place 7,5 points</u>	<u>59th place 3,4 points</u>	<u>89th place 0,4 points</u>
	<u>60th place 3,3 points</u>	<u>90th place 0,3 points</u>
		<u>91th place 0,2 points</u>
		<u>92th place 0,1 points</u>
		<u>93th place and after 0 points</u>

~~2— All other fencers in order of age, starting from the youngest.~~

~~3— The allocation of fencers in the pools must be made in such a way as to place fencers of the same nationality, as far as possible, in different pools, by moving them down the ranking as necessary.~~

~~4— If in any category there are fewer than ten competitors, the competition is held as a poule unique followed by direct elimination.~~

~~5— If in any category there are fewer than 6 competitors, they will fence with the next lower age category. A separate ranking for that category will be extrapolated from the combined categories' final rankings at the end of the competition.~~

~~6— If in any category there is only one competitor, the event in that category is cancelled.~~

~~7— No fencer is eliminated after the pools, all are entered into the direct elimination.~~

## **C. VETERANS**

### ***Team championships***

#### **o.103**

**1— Participation**

Each country may enter one team per gender and per weapon, thus giving a total of 6 competitions.

The teams shall be composed of fencers who participated in the individual competition of the corresponding weapon, but c.f. o.103.2 b below.

~~2—The rules for team competitions are applicable with the following exceptions:~~

- ~~a) For each weapon, the teams are composed of three fencers of the same nationality, one from category "A", one from "B" and one from "C", with or without a reserve for each category. A team cannot begin the match if it is not complete.~~
- ~~b) In the case of a team being short of a fencer in any of the weapons, the team may use a fencer who has competed in the individual championships at another weapon or who is registered but has yet to compete, but his/her ranking will be deemed to be last in the individual competition at the weapon of the team in which he is going to fence plus 1.~~
- ~~c) The teams are placed in the pools according to the ranking of the three fencers in the individual championship, the team having the lowest total being ranked highest. All the fencers registered for the team event must be present at the piste before the start of the match.~~
- ~~d) Each team may request, before a given bout, the substitution of a fencer. However, in case of injury or other medical reason duly recognized by the Medical delegate, the substitution can be immediate, even during the relay.~~

~~There can only be one substitution per team per match.~~

~~3—A fencer who has been replaced because of an injury may not fence again during that match. If both a fencer and the reserve, if any, are forced to retire, or if a fencer is excluded, their team is deemed to have lost the match.~~

~~4—The relay system is always applied. The three fencers of a team fence against their opponent of the same category. Each fencer fences his/her opponent twice giving a total of 6 bouts. The bouts are for 5 hits (5-10-15-20 etc.). Exceptionally, a relay may end at more than 5,10,15 etc. if a fencer scores a valid last hit of the relay and is at the same time awarded an additional penalty hit: in this case both hits will be counted; the maximum time for each bout is 3 minutes.~~

~~5—The team that first reaches the maximum score of 30 hits, or that which has scored the greatest number of hits after the expiry of regulation time, is the winner.~~

~~6—The order of categories for each match is established by the referee with the captains on the piste prior to the start of the match: The referee will draw lots and the winning captain will choose the first category in the order. The losing captain will choose the second category.~~

~~7—The competition consists of a round of pools of 3 or 4 teams, in which all the teams participate, and a direct elimination phase for the highest placed 16 teams; the other teams will be classified according to their ranking after the round of pools.~~

~~a) The order of fights in a pool of 4 is as follows:~~

~~b) Match 1 : The team ranked 1 vs the team ranked 4~~

~~— Match 2 : The team ranked 2 vs the team ranked 3 Match 3 : The winner of Match 1 vs the loser of Match 2~~

~~— Match 4 : The winner of Match 2 vs the loser of Match 1~~

~~— Match 5 and Match 6 : The two remaining matches.~~

~~b) The order of fights in a pool of 3 is as follows:~~

~~— Match 1 : The team ranked 2 vs the team ranked 3~~

~~— Match 2 : The team ranked 1 vs the loser of Match 1~~

~~— Match 3 : The team ranked 1 vs the winner of Match 1~~

~~The initial ranking on which the drawing of the pools is based is established from the results of the fencers in the individual events. (cf. o.103.2.c)~~

~~Using the results of the pools, an overall ranking is established, from which the top 16 (or 8 if there are fewer than 16 teams taking part) are promoted to a direct elimination tableau, in which the teams are placed according to this ranking. Should there be absolute equality in results between teams ranked 16 and 17 (or 8 and 9), the team ranked higher before the round of pools will be qualified.~~

~~However, teams which have already fenced each other in the pools should not meet again immediately in the direct elimination. To avoid this, the lower ranked of the two teams in question may be moved:~~

- ~~– in the case of a tableau of 16, the team ranked 9 may change places only with the team ranked 10, the team ranked 11 may change places only with the team ranked 12, the team ranked 13 may change places only with the team ranked 14 and the team ranked 15 may change places only with the team ranked 16.~~
- ~~– in the case of a tableau of 8, the team ranked 5 may change places only with the team ranked 6 and the team ranked 7 may change places only with the team ranked 8.~~

~~8— If there are fewer than 6 teams, they all fence in a poule unique; a match for the 3rd and 4th places is then held, followed by a match for the first place between the teams who came 1st and 2<sup>nd</sup> in the pool.~~

~~9— The places in the final ranking table from 5th onwards are not fought for and teams are classified, within each round of the table, according to their ranking after the poules.~~

---

## **o.103**

### ~~1— Participation~~

~~Each country may enter one team per category (Veterans and Grand Veterans) per gender and per weapon, thus giving a total of twelve competitions.~~

~~The teams shall be composed of fencers who participated in the individual competition of the corresponding weapon, but c.f. o.103.2 b below.~~

### ~~2— The rules for team competitions are applicable with the following exceptions:~~

~~**Veterans:** teams of three composed of fencers belonging to either age group 40-49 or to age group 50-59, with at least one fencer belonging to age group 50-59, plus up to two reserves.~~

~~**Grand Veterans:** teams of three composed of fencers belonging to either age group 60-69 or to age group 70 and over, with at least one fencer belonging to age group 70 and over, plus up to two reserves.~~

~~Fencing mode is 45 hits relay described in o.99 with application of passivity rule at any bout.~~

~~The competition begins with a round of pools of 3 and 4 teams established according to o.103 c) and followed by a direct elimination phase according to o.103 7.~~

~~Particular cases depending on the number of teams:~~

- ~~• 1 team: the organisers must inform all nations that there will be no competition at that weapon.~~
- ~~• 2 teams: only one match between these two teams.~~
- ~~• 3 teams: one poule of three followed by D.E. from an incomplete tableau of 4.~~



~~• 4 teams: one poule of four followed by D.E. from a tableau of 4.~~

~~• 5 teams: one poule of five followed by D.E. from an incomplete tableau of 8.~~

~~The losers of the semi-finals have to fence for the Bronze medal.~~

~~a) — In the case of a team being short of a fencer in any of the weapons, the team may use a fencer who has competed in the individual championships at another weapon or who is registered but has yet to compete, but his/her ranking will be deemed to be last in the individual competition at the weapon of the team in which he is going to fence plus 1.~~

~~b) — The teams are placed in the pools according to the ranking of the three fencers in the individual championship, the team having the lowest total being ranked highest. All the fencers registered for the team event must be present at the piste before the start of the match.~~

~~c) — Each team may request, before a given bout, the substitution of a fencer. However, in case of injury or other medical reason, duly recognized by the medical delegate, the substitution can be immediate, even during the relay.~~

~~There can be up to two substitutions of reserves per match but must maintain compliance with the age category representation requirement.~~

~~3 — A fencer who has been replaced because of an injury or other medical reason may not fence again during that match. If both a fencer and the reserve, if any, are forced to retire, or if a fencer is excluded, their team is deemed to have lost the match.~~

~~4 — The competition consists of a round of pools of 3 or 4 teams, in which all the teams participate, and a direct elimination phase for the highest placed 16 teams; the other teams will be classified according to their ranking after the round of pools.~~

~~a) — The order of fights in a pool of 4 is as follows:~~

~~Match 1 : The team ranked 1 vs the team ranked 4~~

~~Match 2 : The team ranked 2 vs the team ranked 3~~

~~Match 3 : The winner of Match 1 vs the loser of Match 2~~

~~Match 4 : The winner of Match 2 vs the loser of Match 1~~

~~Match 5 and Match 6 : The two remaining matches.~~

~~b) — The order of fights in a pool of 3 is as follows:~~

~~Match 1 : The team ranked 2 vs the team ranked 3~~

~~Match 2 : The team ranked 1 vs the loser of Match 1~~

~~Match 3 : The team ranked 1 vs the winner of Match 1~~

~~The initial ranking on which the drawing of the pools is based is established from the results of the fencers in the individual events. (cf. o.103.2.c)~~

~~Using the results of the pools, an overall ranking is established, from which the top 16 (or 8 if there are fewer than 16 teams taking part) are promoted to a direct elimination tableau, in which the teams are placed according to this ranking. Should there be absolute equality in results between teams ranked 16 and 17 (or 8 and 9), the team ranked higher before the round of pools will be qualified.~~

~~However, teams which have already fenced each other in the pools should not meet again immediately in the direct elimination. To avoid this, the lower ranked of the two teams in question may be moved:~~

~~– in the case of a tableau of 16, the team ranked 9 may change places only with the team ranked 10, the team ranked 11 may change places only with the team ranked 12, the team ranked 13 may change places only with the team ranked 14 and the team ranked 15 may change places only with the team ranked 16.~~

- ~~— in the case of a tableau of 8, the team ranked 5 may change places only with the team ranked 6 and the team ranked 7 may change places only with the team ranked 8.~~
- ~~5— If there are fewer than 6 teams, they all fence in a poule unique; a match for the 3rd and 4th places is then held, followed by a match for the first place between the teams who came 1st and 2<sup>nd</sup> in the pool.~~
- ~~6— The places in the final ranking table from 5th onwards are not fought for and teams are classified, within each round of the table, according to their ranking after the poules.~~

**Application :** during the test at the 2025 World Championships (not applicable in 2023 and 2024)

---

## **D.C. OLYMPIC GAMES**

### **o.104**

The organisation formulae for the Olympic Games are established by the Executive Committee, with the approval of the IOC. (See art. 9.1.1.1 of the Administrative rules).

---

## **PART C - VETERANS**

### **BODIES RESPONSIBLE FOR ORGANISATION AND CONTROL**

#### **Organising Committee Veterans**

### **o.111**

The Directoire Technique is composed of people who have the experience and competence to organise competitions.

The Directoire Technique is composed of four members of different nationalities, one of whom must represent the country where the competition is held **and, if possible, a representative of the country where the competition will be held the following year.**

#### **Appointment of refereeing, SEMI and medical delegates**

### **o.112**

Refereeing delegates must be members of the FIE Refereeing Commission.

SEMI delegates must be members of the FIE SEMI Commission.

Medical delegates must be members of the FIE Medical Commission.

#### **Veterans World Championships**

Two Refereeing delegates, one SEMI delegate and two Medical delegates are appointed by the FIE Executive Committee following the recommendations of the respective commissions.

#### **Refereeing**

### **o.113**

Refereeing at Veteran World Championships is carried out by referees appointed by the Executive Committee of the FIE, selected by the Refereeing Commission on indication of the Organizing Committee and Veterans Council.

Referees must attend the refereeing meeting that takes place the day before the World Championships.

## **AGE OF PARTICIPANTS**

### **o.114**

The age groups in veteran competitions are:

- a) Age group 50-59: Must be at least 50 years old and less than 60 years old in the year of the competition.
- b) Age group 60-69: Must be at least 60 years old and less than 70 years old in the year of the competition.
- c) Age group 70+: Must be at least 70 years old in the year of the competition.

---

The age groups in veteran competitions are:

- a) Age group 40-49: Must be at least 40 years old and less than 50 years old in the year of the competition.
- b) Age group 50-59: Must be at least 50 years old and less than 60 years old in the year of the competition.
- c) Age group 60-69: Must be at least 60 years old and less than 70 years old in the year of the competition.
- d) Age group 70+: Must be at least 70 years old in the year of the competition.

**Application: during the test at the 2025 World Championships (not applicable in 2023 and 2024).**

---

## ***Pre-competition procedures***

### **PROGRAMMING**

#### **VETERANS WORLD CHAMPIONSHIPS**

##### **o.115**

- 1 The programme of the Veteran World Fencing Championships comprises twenty-four events, eighteen individual – three categories for each weapon - and six team — male foil, female foil, male epee, female epee, male sabre and female sabre. The programme must be arranged in such a way as to allow any fencer to participate in all weapons. Team events must be held on the day following the last championship of the three categories of each weapon.
- 2 No changes of dates are allowed for any competition, after the release of the programme.
- 3 Each competition must be held in one single day, avoiding long periods of inactivity.

- 
- 1 The programme of the Veteran World Fencing Championships comprises thirty-six events, twenty-four individual – four categories for each weapon - and twelve team — male foil, female foil, male epee, female epee, male sabre and female sabre (two categories for each weapon and gender). The programme must be arranged in such a way as to allow any fencer to participate in all weapons. Team events must be held on the day following the last championship of the corresponding two individual categories of each weapon.
  - 2 No changes of dates are allowed for any competition, after the release of the programme.
  - 3 Each competition must be held in one single day, except for team events for which the round of pools may be achieved the day before direct elimination avoiding long periods of inactivity.

**Application: during the test at the 2025 World Championships (not applicable in 2023 and 2024).**

---

## **INVITATIONS**

## **Invitation to international officials**

### **Veterans**

#### **o.116**

- 1 Any proposed candidature for organising the Veteran World Championships must be studied at the venue concerned by an ad hoc delegation designated by the Executive Committee, at the invitation of the candidate federation.
- 2 The organising committee, who will receive all the entry fees from the participating delegations, must, at their own expense, invite the following international officials (tourist-class return air fare, accommodation and daily allowances):
  - a) The President of the FIE or his representative, who presides over the World Championships and, in particular, controls the smooth running of the Directoire Technique.
  - b) Four members of the Directoire Technique appointed by the Executive Committee of the FIE, one of whom must belong to the organising country.
  - c) One member of the SEMI-~~Committee~~-Commission, appointed by the Executive Committee of the FIE.
  - d) ~~One~~ Two members of the Refereeing ~~Committee~~-Commission, appointed by the Executive Committee of the FIE.
  - e) Two members of the Medical ~~Committee~~-Commission, appointed by the Executive Committee of the FIE.
  - f) The referees appointed by the Executive Committee of the FIE.

The officials a) to e) should preferably be selected from the Zone in which the Championships are being held.

### **ENTRIES**

## **Veterans World Championships**

### **Entries for competitions**

#### **o.117**

- 1 The **entry of the names** of the fencers and all possible replacements, and the entry of teams, must be made via the FIE website 7 days before the competition at the latest (midnight Lausanne time). For team entries, the names of the fencers making up the teams may be changed, by informing the organizers, up to the day before the competition, not later than 4.00 pm (local time). However, a replacement can be made after this stage, and at the latest at the end of the individual event, in the case of injury or other medical reason duly certified by the competition medical doctor.
- 2 **Withdrawal of a fencer or team.**

After the closing deadline for entries, no named fencer or team may be withdrawn except for injury or other medical reason or force majeure: the national federation must inform the FIE and the organizers.
- 3 **Substitution of a fencer.**

Until the Wednesday preceding the competition (midnight, Lausanne time), a fencer may be replaced by another. To do this, the national federation must send to the FIE, by fax or e-mail, a written request to substitute the fencer.
- 4 **Addition of a fencer or a team after the dead-line.**

From the Wednesday preceding the competition until 12 noon (local time) on the day preceding the competition, one or more fencers and/or a team may be added by national federations after payment to the FIE of a penalty according to the scale in force (cf o.31, table of financial penalties and fines).
- 5 Should a fencer or team who have been entered not present themselves to fence, a fine (cf o.31, table of financial penalties and fines), payable to the FIE, will be imposed to the federation of the faulty fencer or team, except in cases of properly authenticated 'force majeure'.

- 6 The organisers of all official competitions must, at risk of a penalty of a fine payable to the FIE (cf o.31, table of financial penalties and fines), refuse any entry of either fencer or referee not in possession of an FIE license valid for the current season.

## **PROCEDURES DURING COMPETITIONS**

### **Composition of the pools for the individual Veterans championships**

#### **o.118**

The pools are composed taking into account the following orders of strength:

- 1 The fencers ranked from the addition of the results in the previous two ~~years~~ Veterans World Championships, irrespective of age category changes.

Scores are awarded according to the following table:

1st place 80 points	31th place 7 points	61th place 3,2 points
2nd place 65 points	32th place 6,5 points	62th place 3,1 points
3rd place <i>ex aequo</i> 50 points	33th place 6 points	63th place 3 points
5th place 38 points	34th place 5,9 points	64th place 2,9 points
6th place 36 points	35th place 5,8 points	65th place 2,8 points
7th place 34 points	36th place 5,7 points	66th place 2,7 points
8th place 32 points	37th place 5,6 points	67th place 2,6 points
9th place 30 points	38th place 5,5 points	68th place 2,5 points
10th place 28 points	39th place 5,4 points	69th place 2,4 points
11th place 26 points	40th place 5,3 points	70th place 2,3 points
12th place 24 points	41th place 5,2 points	71th place 2,2 points
13th place 22 points	42th place 5,1 points	72th place 2,1 points
14th place 20 points	43th place 5 points	73th place 2 points
15th place 18 points	44th place 4,9 points	74th place 1,9 points
16th place 16 points	45th place 4,8 points	75th place 1,8 points
17th place 14 points	46th place 4,7 points	76th place 1,7 points
18th place 13,5 points	47th place 4,6 points	77th place 1,6 points
19th place 13 points	48th place 4,5 points	78th place 1,5 points
20th place 12,5 points	49th place 4,4 points	79th place 1,4 points
21th place 12 points	50th place 4,3 points	80th place 1,3 points
22th place 11,5 points	51th place 4,2 points	81th place 1,2 points
23th place 11 points	52th place 4,1 points	82th place 1,1 points
24th place 10,5 points	53th place 4 points	83th place 1 points
25th place 10 points	54th place 3,9 points	84th place 0,9 points
26th place 9,5 points	55th place 3,8 points	85th place 0,8 points
27th place 9 points	56th place 3,7 points	86th place 0,7 points
28th place 8,5 points	57th place 3,6 points	87th place 0,6 points
29th place 8 points	58th place 3,5 points	88th place 0,5 points
30th place 7,5 points	59th place 3,4 points	89th place 0,4 points
	60th place 3,3 points	90th place 0,3 points

91th place 0,2 points  
92th place 0,1 points  
93th place and after 0 points

- 2 All other fencers in order of age, starting from the youngest.
- 3 The allocation of fencers in the pools must be made in such a way as to place fencers of the same nationality in different pools, as far as possible (staggering).
- 4 If in any category there are fewer than ten competitors, the competition is held as a poule unique followed by direct elimination.
- 5 If in any category there are fewer than 6 competitors, they will fence with the next lower age category. A separate ranking for that category will be extrapolated from the combined categories' final rankings at the end of the competition.
- 6 If in any category there is only one competitor, the event in that category is cancelled.
- 7 No fencer is eliminated after the pools. All the fencers participate in the direct elimination phase.

## **VETERANS TEAM EVENTS**

### **o.119**

#### **1 Participation**

Each country may enter one team per gender and per weapon, thus giving a total of 6 competitions. The teams shall be composed of fencers who participated in the individual competition of the corresponding weapon, but c.f. o.103.2 b below.

- 2 The rules for team competitions are applicable with the following exceptions:
  - a) For each weapon, the teams are composed of three fencers of the same nationality, one from category "A", one from "B" and one from "C", with or without a reserve for each category. A team cannot begin the match if it is not complete.
  - b) In the case of a team being short of a fencer in any of the weapons, the team may use a fencer who has competed in the individual championships at another weapon or who is registered but has yet to compete, but his/her ranking will be deemed to be last in the individual competition at the weapon of the team in which he is going to fence plus 1.
  - c) The teams are placed in the pools according to the ranking of the three fencers in the individual championship. The team ranked 1 is the one having the lowest total. All the fencers registered for the team event must be present at the piste before the start of each match.
  - d) Each team may request, before a given relay, the substitution of a fencer. However, in case of injury or other medical reason duly recognized by the Medical delegate, the substitution can be immediate, even during the relay.

There can only be one substitution per team per match.

- 3 A fencer who has been replaced because of an injury may not fence again during that match. If both a fencer and the reserve are forced to retire, or if a fencer is excluded, their team is deemed to have lost the match.

- 4 The relay system is always applied. The three fencers of a team fence against their opponent of the same category. Each fencer fences his/her opponent twice giving a total of 6 relays. The relays are for 5 hits (5-10-15-20- etc.). Exceptionally, a relay may end at more than 5,10,15 etc. if a fencer scores a valid last hit of the relay and is at the same time awarded an additional penalty hit: in this case both hits will be counted; the maximum time for each relays is 3 minutes.
- 5 The team that first reaches the maximum score of 30 hits, or that which has scored the greatest number of hits after the expiry of regulation time, is the winner.
- 6 The order of categories for each match is established by the referee with the captains on the piste prior to the start of the match: The referee will draw lots and the winning captain will choose the first category in the order. The losing captain will choose the second category.
- 7 The competition consists of a round of pools of 3 or 4 teams, in which all the teams participate, and a direct elimination phase for the highest placed 16 teams; the other teams will be classified according to their ranking after the round of pools.
  - a) The order of matches in a pool of 4 is as follows:  
 Match 1 : The team ranked 1 vs the team ranked 4  
 Match 2 : The team ranked 2 vs the team ranked 3  
 Match 3 : The winner of Match 1 vs the loser of Match 2  
 Match 4 : The winner of Match 2 vs the loser of Match 1  
 Match 5 and Match 6 : The two remaining matches.
  - b) The order of matches in a pool of 3 is as follows:  
 Match 1 : The team ranked 2 vs the team ranked 3  
 Match 2 : The team ranked 1 vs the loser of Match 1  
 Match 3 : The team ranked 1 vs the winner of Match 1

The initial ranking on which the drawing of the pools is based is established from the results of the fencers in the individual events. (cf. o.103.2.c)

The composition of the direct elimination table of 16 teams (or 8 if there are less than 16 teams) is established according to the general ranking established by the results of all the teams in the pool round. In the event of an absolute tie between the teams ranked 16 and 17 (or 8 and 9), the highest ranked team in the initial pool ranking shall qualify.

However, in no case, teams which have already fenced each other in the pools should meet again immediately in the direct elimination. To avoid this, the lower ranked of the two teams in question may be moved:

- in the case of a tableau of 16, the team ranked 9 may change places only with the team ranked 10, the team ranked 11 may change places only with the team ranked 12, the team ranked 13 may change places only with the team ranked 14 and the team ranked 15 may change places only with the team ranked 16.
  - in the case of a tableau of 8, the team ranked 5 may change places only with the team ranked 6 and the team ranked 7 may change places only with the team ranked 8.
- 8 If fewer than 6 teams participate in the competition, they all fence in a poule unique; a match for the 3rd and 4th places is then held, followed by a match for the first place between the teams who came 1st and 2nd in the pool.
  - 9 Ranking matches from 5th place onwards will not be fenced and teams will be ranked, in each round of the table, according to their ranking after the pools.

## 1 Participation

Each country may enter one team per category (Veterans and Grand Veterans) per gender and per weapon, thus giving a total of twelve competitions.

The teams shall be composed of fencers who participated in the individual competition of the corresponding weapon, but c.f. o.103.2 b below.

**2** The rules for team competitions are applicable with the following exceptions:

Veterans: teams of three composed of fencers belonging to either age group 40-49 or to age group 50-59, with at least one fencer belonging to age group 50-59, plus up to two reserves.

Grand Veterans: teams of three composed of fencers belonging to either age group 60-69 or to age group 70 and over, with at least one fencer belonging to age group 70 and over, plus up to two reserves.

Fencing mode is 45 hits relay described in o.99 with application of non-combativity rule at any match.

The competition begins with a round of pools of 3 and 4 teams -established according to o.103 c) - and followed by a direct elimination phase according to o.103 7.

Particular cases depending on the number of teams:

- only 1 team: the organisers must inform all nations that there will be no competition at that weapon.
- 2 teams: only one match between these two teams.
- 3 teams: one poule of three followed by D.E. from an incomplete tableau of 4.
- 4 teams: one poule of four followed by D.E. from a tableau of 4.
- 5 teams: one poule of five followed by D.E. from an incomplete tableau of 8.

The losers of the semi-finals have to fence for the Bronze medal.

- a) In the case of a team being short of a fencer in any of the weapons, the team may use a fencer who has competed in the individual championships at another weapon or who is registered but has yet to compete, but his/her ranking will be deemed to be last in the individual competition at the weapon of the team in which he is going to fence plus 1.
- b) The teams are placed in the pools according to the ranking of the three fencers in the individual championship. The number 1 team is the one with the least points. All the fencers registered for the team event must be present at the piste before the start of each match.
- c) Each team may request, before a given relay, the substitution of a fencer. However, in case of injury or other medical reason, duly recognized by the medical delegate, the substitution can be immediate, even during the relay.

There can be up to two substitutions of reserves per match but must maintain compliance with the age category representation requirement.

**Application** : during the test at the 2025 World Championships (not applicable in 2023 and 2024)

**Opinion of the Refereeing Commission:**

- **In favour with creation of new chapter for Veterans World Championship**
- **Modification of o.112 in proposal to reduce unnecessary repetitions as below**

**o.112**

**Two Refereeing delegates, one SEMI delegate and two Medical delegates must be the members of the FIE Commissions and be appointed by the FIE Executive Committee following the recommendations of the respective commissions.**



**Article:** o.99

**Proposal from:** Rules Commission

**Motivation:** Define the rest time between two matches per team.

**o.99**

10 A 10-minute rest must always be given between two matches of the same team.

**Opinion of the Refereeing Commission: in favour**

P.13

**Article:** o.105

**Proposal from:** Rules Commission

**Motivation:** the zone championships benefit from a coefficient of 1.5. 4 or 8 pistes must be equipped with video refereeing.

**Video-refereeing**

**o.105**

4. For individual competitions of the Junior and Cadet World Championships, video-refereeing is compulsory as soon as the timetable allows the competition to be run on a maximum of 8 pistes, all equipped for video-refereeing and in any case, from the table of 32.

For team competitions ~~in the conventional weapons~~, video-refereeing is compulsory **from the table of 16**, including ranking matches table 5-8.

~~In epee, video-refereeing is compulsory from the table of 8, including ranking matches table 5-8.~~

Senior zonal championships	T 64	T 16	<del>4</del> or 8	T 1-8
----------------------------	------	------	-------------------	-------

**Opinion of the Refereeing Commission:**

**In favour with modification o.105.4 and o.105.5 as below**

Senior zonal championships	T 64	T 16	4 or 8	T 1-8
----------------------------	------	------	--------	-------



Proposals for the 2023 Congress

Modifications of the Technical Rules

The texts below are applicable on January 1st, 2024, unless mentioned otherwise.

Article: **t.18**

P. 19

Proposal from: Rules Commission

**Motivation:** In the last 2m of the piste, draw a line down the middle (1m). This allows the Referee to define more precisely the lateral exit of the foot(s) to judge whether or not the rear limit has been left.

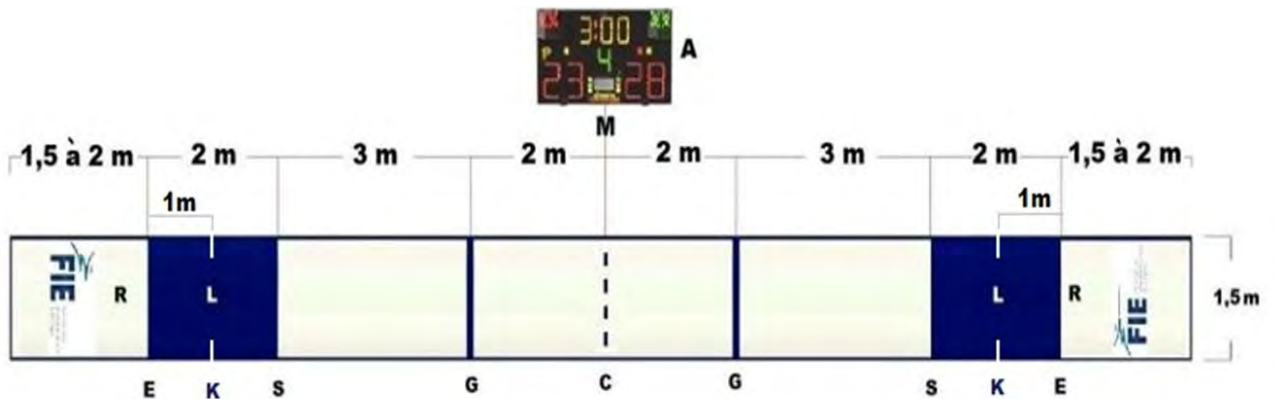
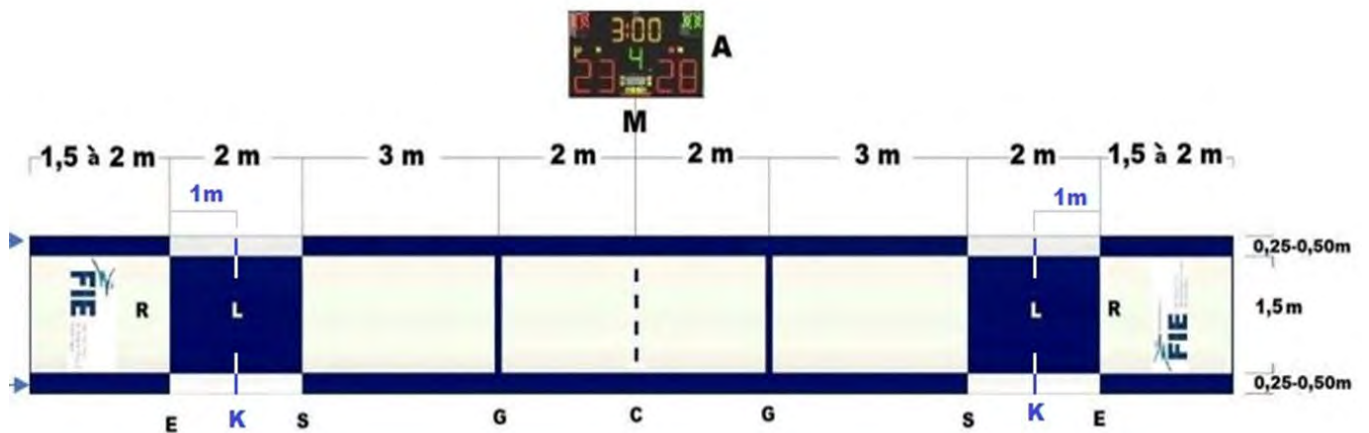

Opinion of the Refereeing Commission: not in favour

**Article:** t.23, t.25, t.26, t.27, t.29, t.35, t.43, t.45, t.55, t.71, t.73, t.76, t.90, t.96, t.110, t.116, t.120, t.123, t.125, t.128, t.133, t.172.

**Proposal from:** Rules Commission

**Motivation:** Add and correct the groups of sanctions in the main article to be consistent with t.170

#### t.23

- 6 The Referee may not allow a fencer to **leave the piste**, save in exceptional circumstances. If a competitor does so without permission he is liable to incur the penalties enumerated in Articles t.158-162, t.165, t.170-, [for the offences of the 1st group](#).

#### t.25

- 2 **At all three weapons** it is forbidden for a fencer to **cause corps à corps intentionally** to avoid being hit, or to jostle his opponent. Should such an offence occur, the Referee will penalise the fencer at fault as specified in Articles t.158-162, t.165, t.170 -, [for the offences of the 1st group](#) and any hit scored by the fencer at fault is annulled.

#### t.26

- 1 The 'flèche ending systematically in a corps à corps' referred to in this article must not be confused with the 'flèche resulting in a shock which jostles the opponent', which is considered as an act of **intentional brutality** at all three weapons and is punished as such (cf. t.121.2, t.170)-, [for the offences of the 2nd group](#).

#### t.27

- 2 It is forbidden to **turn one's back** on one's opponent during the bout. Should such an offence occur, the Referee will penalise the fencer at fault as specified in articles t.158-162, t.165, t.170-, [for the offences of the 1st group](#) and any hit scored by the fencer at fault is annulled.

#### t.29

- 1 The use of the **non-sword hand** and **arm** to carry out an offensive or defensive action is forbidden (cf t.158-162, ~~t.165~~, **t.166**, t.170). Should such an offence occur, the hit scored by the fencer at fault is annulled and the latter will be penalized as specified for offences of the 2nd group (red card).
- 2 If a fencer **substitutes a non-valid part of his target for a valid part**, either by covering it or by any abnormal movement, the **Referee must penalise him by** applying the penalties specified in Articles t.158-162, t.165, t.170-, [for the offences of the 1st group](#) and any hit scored by the fencer at fault is annulled.
- 3 During the fight, the fencer must not, under any circumstances, **take hold of any part of the electrical equipment** with his non-sword hand; [the referee imposes him/her the penalties for the offences of the first group](#) (cf. t.158-162, t.165, t.170); any hit scored by the fencer at fault is annulled.

#### t.35

- 3 A competitor who crosses one of the lateral boundaries of the piste with both feet — e.g. when making a flèche — **to avoid being hit** will be penalised as specified in Articles t.158-162, t.165, t.170-, [for the offences of the 1st group](#).

#### t.43

- 2 Any fencer who attempts improperly to **cause or to prolong interruptions** to the bout is penalised as specified in Articles t.158-162, t.165, t.170-, [for the offences of the 1st group](#).

#### t.45

- 3 Should a fencer **demand a break** which is deemed by the delegate of the Medical Commission or, in his absence, by the doctor on duty to be **unjustified**, the Referee will penalise that fencer as specified in Articles t.158-162, t.166, t.170 **for the offences of the 2nd group**.

#### t.55

- 2 A competitor who, **intentionally**, causes the apparatus to register a hit by placing his point on the ground or on any surface other than **that of his opponent** will be penalised as specified in Articles **t.158-162, t.165, t.166, t.170-**, **for the offences of the 2nd group**.

#### t.71

If a fencer appears on the piste:

- with only **one** regulation **weapon** (cf. t.114, 115); or
- with only **one** regulation **bodywire**; or
- with only **one** regulation **mask wire**; or
- with **a weapon or a bodywire which does not work** or which **does not conform** with the Rules; or
- without his **protective under-plastron** (cf. t.64.5); or
- with a **conductive jacket** which does not fully cover the valid target; or
- with a mask whose 2nd security device is not securely fixed to the body of the mask; or
- with **clothing** which does not conform with the Rules;

the Referee will apply the penalties stipulated in Articles t.158-162, t.165, t.170-, **for the offences of the 1st group**.

#### t.73

- 1 If, when a fencer appears on the piste or during a bout, it is established that the equipment used by the fencer:
- a) **does not bear the marks** applied at the preliminary check, the Referee will:
- annul the last hit, if any, scored by the fencer at fault;
  - penalise him as specified in Articles **t.158-162, t.166, t.170-**, **for the offences of the 2nd group**.
- b) does not conform to the rules in a way **not covered by the preliminary check**, the Referee will:
- penalise him as specified in Articles **t.158-162, t.166, t.170.** , **for the offences of the 2nd group**.

#### t.76

- 2 **Pushing or letting drag** the point of the electric weapon on the electric piste is forbidden during the actual bout (between 'Play!' and 'Halt!'). Placing the weapon on the piste at any time to **straighten** it is also forbidden. Any breaking of these rules will be punished according to Articles t.158-162, t.165, t.170-, **for the offences of the 1st group**.

#### t.90

- 2 **Pushing** or letting the point of the electric weapon **drag** on the electric piste is forbidden during the actual bout (between 'Play!' and 'Halt!'). Placing the weapon on the piste at any time to **straighten** it is also forbidden.  
Any breaking of this rule will be penalised according to Articles t.158-162, t.165, t.170-, **for the offences of the 1st group**.

#### t.96

- 3 It is forbidden to **hit with the guard**. Any hits registered by hitting with the guard must be annulled, the fencer so hitting being penalised as specified in Articles t.158-163, t.165, t.170., **for the offences of the 2nd group**.

**5 Placing the weapon on the piste at any time to straighten it** is forbidden. Any breaking of this rule will be punished according to Articles t. 158-163, t.165, t.170-, [for the offences of the 1st group](#).

**t.110**

**Smoking** in competition halls is forbidden. Smoking will be considered as a disturbance of the smooth running of the competition (cf. t.111).

Any breach of these rules will be punished as laid down in Articles **t.158-162, t.167, t.168, t.170.** , [for the offences of the 3rd group](#).

**t.116**

Under no circumstances should the fencers **dress or undress in public** except in the case of an accident duly recognised by the doctor on duty or by the representative of the Medical Commission (cf. **t.126, t.158-162, t.165, t.170.**)-, [Any infringement will be sanctioned for the offences of the 1st group](#).

**t.120**

Should a fencer **abandon a bout** by leaving the piste (cf. **t.23.6**), he will be penalised as specified in Articles **t.158-162, t.165, t.170.**-, [for the offences of the 1st group](#).

**t.123**

During or after a bout, even if the fencer has already left the piste, any act against the spirit of sportsmanship such as violently or dangerously throwing one's mask or any other piece of equipment will be penalised as specified in article **t.169 (c.f. t.108.1, 2 and t.109)**-, [for the offences of the 4th group](#).

**t.125**

The fencer, whether on or off the piste, must **keep his mask on** until the Referee calls 'Halt!' He may under no circumstances address the Referee until the Referee has made his decision (cf. **t.158- 162, t.165, t.170)**-, [Any infringement will be sanctioned for the offences of the 1st group](#).

**t.128**

Competitors must **fence to their utmost ability** in a sportsmanlike manner until the end of the competition in order to obtain the best possible classification, without giving away hits or seeking to be favoured by being given hits by anyone (cf. **t.158-162, t.169, t.170)**-, [Any infringement will be sanctioned for the offences of the 4th group](#).

**t.133**

Spectators are obliged not to **interfere with the good order** of a competition, to do nothing which may tend to influence the fencers or the Referee, and to respect the decisions of the latter even when they do not agree with them. They must obey any instructions which the Referee may deem it necessary to give them (cf. **t.109-110, t.167-168, t.170**) .-, [the penalties for the offences of the 3rd group](#).

**t.172**

- 2 If a fencer infringes this principle, **casting doubt** on the decision of the Referee **on a point of fact** during the bout, he will be penalised according to the rules (cf. **t.158-162, t.165, t.170)**-, [for the offences of the 1st group](#). But if the Referee **is ignorant of or misunderstands a definite rule**, or applies it in a manner contrary to the Rules, an appeal on this matter may be entertained. A point of fact includes, but is not limited to, any ruling by the referee analysing what happened on the piste, such as the validity or priority of a hit, whether a fencer left the side or end of the piste or if a person's behaviour is a Group 3 or Group 4 offence.

**Opinion of the Refereeing Commission:**

**not in favour of the additional text concerning a group of penalties but in favour for correctness of article numbers as below**

**t.29**

1 The use of the **non-sword hand** and **arm** to carry out an offensive or defensive action is forbidden (cf t.158-162, ~~t.165, t.166~~, t.170). Should such an offence occur, the hit scored by the fencer at fault is annulled and the latter will be penalized as specified for offences of the 2nd group (red card).

#### t.55

2 A competitor who, **intentionally**, causes the apparatus to register a hit by placing his point on the ground or on any surface other than **that of his opponent** will be penalised as specified in Articles **t.158-162, t.165, t.166, t.170**, ~~for the offences of the 2nd group~~.

---

**Article:** **t.35**

**Proposal from:** Rules Commission

**Motivation:** Add in t.35.3 the cancellation of the fencer's hit to be consistent with t.170

P.22

#### t.35

3 A competitor who crosses one of the lateral boundaries of the piste with both feet — e.g. when making a flèche — to avoid being hit will be penalised as specified in Articles t.158-162, t.165, t.170. **Any hit made by the offending fencer is annulled.**

**Opinion of the Refereeing Commission: not in favour as it is clear in the rules:**

**t.33.2 If the fencer goes off the piste with both feet, the Referee must annul everything that has occurred after the boundary has been crossed, except a hit received by the competitor who has crossed the boundary even after he has crossed it, provided that this hit results from a simple and immediate action.**

---

**Article:** **t.41**

**Proposal from:** Rules Commission

**Motivation:** In epee, the first two opponents can both reach the score of 5 hits by a double hit.

P.23

#### Team competitions

##### t.41

2 The first two opponents fence until one **or both of them have** scored five hits, within the time limit of 3 minutes.

The next two opponents fence until one **or both\*** of their scores has reached ten hits, within the time limit of 3 minutes, and so on with successive bouts, cumulatively, of five hits.

\*this modification occurs in English only

**Opinion of the Refereeing Commission: in favour**

**Article:** t.56.3

**Proposal from:** Refereeing Commission

**Motivation:** Remove t.47.2 (Duties of referees) from t.56.3

**t.56.3**

A competitor who makes any modification in or who changes his equipment without being asked by the Referee to do so, before the Referee has given his decision, loses all right to the annulment of the hit (~~cf. t.47.2.d~~).

**Opinion of the Refereeing Commission: in favour**

**Article:** t.56 and t. 170

**Proposal from:** Refereeing Commission

**Motivation:** intentional dropping the weapon during the bout should be penalized stronger and added to the second group of penalties.

11. A competitor who, intentionally drops weapon during the fencing phrase will be penalized as specified in Articles t.166, t.170. However, a hit scored by the opponent is valid, provided that the action was started before the 'Halt!'.

	2nd group		1st offence	2nd offence	3rd offence and subseq.
2.1	Use of non-sword arm/hand *	t.29.1, t.30	RED	RED	RED
2.2	Demanding a break for medical reason deemed unjustified by doctor	t.45.3			
2.3	Absence of weapon control marks *	t.75.1a			
2.4	Intentionally dropping a weapon during the fencing phrase	t.56.11			
2.5	Deliberate hit not on opponent *	t.55.3			

2.6	Dangerous, violent or vindictive action, blow with guard or pommel *	t.121.2, t.147, t.149.1			
-----	--	-------------------------------	--	--	--

**Opinion of the Refereeing Commission: in favour**

**Article: t.61**

**P.27**

**Proposal from: Rules Commission**

**Motivation:** To clarify the use of video refereeing in the pool phase of the Zonal Qualifying Event for the O.G. Appeals for Video Refereeing

**t.61**

**In the individual events**, the fencer has :

- in pools, ~~one possible appeal during each bout;~~ only in the zonal qualifying event for the Olympic Games is video refereeing compulsory in the pools. The fencer has only one possibility of appeal in each period.
- in **direct elimination bouts**, two possible appeals. Should **the referee agree with the fencer** who appealed for the video-refereeing, the latter is entitled to retain the right of appeal.

**Opinion of the Refereeing Commission:**

**not in favour as it is clear in FIE Organisation rules o.105.5**

**Article: t.64 and t.170.4.1**

**P.28**

**Proposal from: Fencing Federation of Jamaica**

**Motivation:** The motivation for this proposal is to enable fencers and federations who are unable to provide a coach at a competition to have access to a coach via virtual means in the future. This would help to level the playing field by removing financial and resource constraints that can limit a fencer's opportunities. By providing virtual coaching, fencers would have access to guidance and support that they might not otherwise have, which would help them to perform at their best and reach their full potential. Ultimately, this proposal aims to promote greater inclusivity and equity in fencing, allowing more athletes to participate and compete on a fair and equal footing.

Insert item #7

**Regulation equipment and checking of equipment by the referee**

**t.64**

7. the virtual coaching mechanism is activated, and in the unobstructed designated area for coaches.



**t.170, 4.1**

"Fencer equipped with electronic communication equipment permitting ~~him~~ to receive communications during bout"

Fencer equipped with electronic communication equipment permitting ~~him~~ to receive communications during bout, *unless previously authorized virtual coach device to communicate with fencer during authorized moments, in coaching area.*

**Opinion of the Refereeing Commission: not in favour**

---

**Article:** **t.70**

**Proposal from:** Rules Commission

**Motivation:** Add m.11 Fixation of the tip to t.70 material not in conformity.

P. 29

***Non-standard equipment***

**t.70**

In whatever circumstances a fencer on the piste is found to be in possession of equipment which is **non-regulation or defective** (cf.m.8, m.9, m.11, m.12, m.13, m.16, m.17, m.23), the referee confiscates the equipment and submits it to the experts on duty for examination. The equipment in question will only be returned to the owner after the measures necessitated by this examination have been completed and, if appropriate, after the payment of any expenses for repairs. The equipment must be rechecked before it is used again.

**Opinion of the Refereeing Commission: modify proposition as below**

**t.70**

In whatever circumstances a fencer on the piste is found to be in possession of equipment which is **non-regulation or defective in accordance with FIE Material rules** (cf.m.8, m.9, m.11, m.12, m.13, m.16, m.17, m.23), the referee confiscates the equipment and submits it to the experts on duty for examination. The equipment in question will only be returned to the owner after the measures necessitated by this examination have been completed and, if appropriate, after the payment of any expenses for repairs. The equipment must be rechecked before it is used again.

---

**Article:** **t.77, t.91 and t.98**

**Proposal from:** Rules Commission

**Motivation:** Update of the drawings concerning the valid target at the three weapons.

P.30

**t.77**

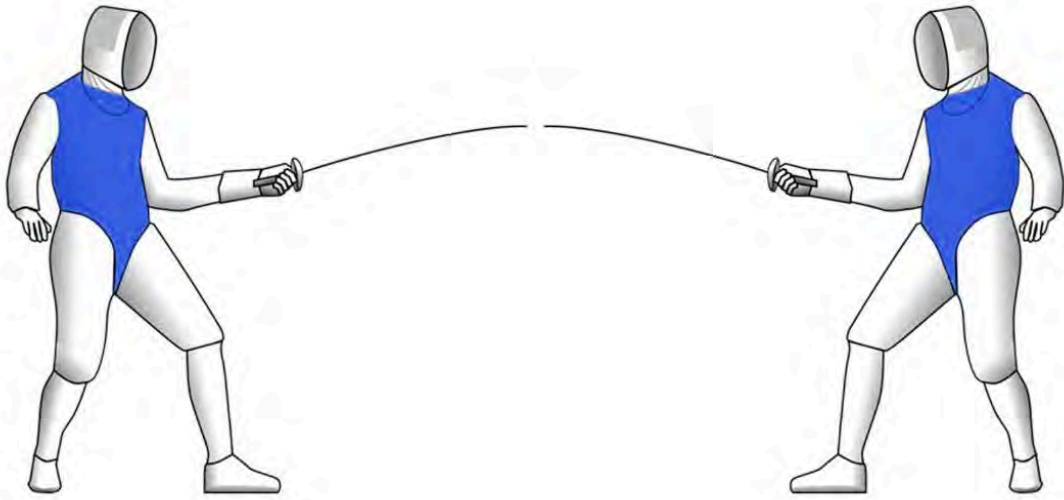

Figure 4 Valid target at foil

**t.91**

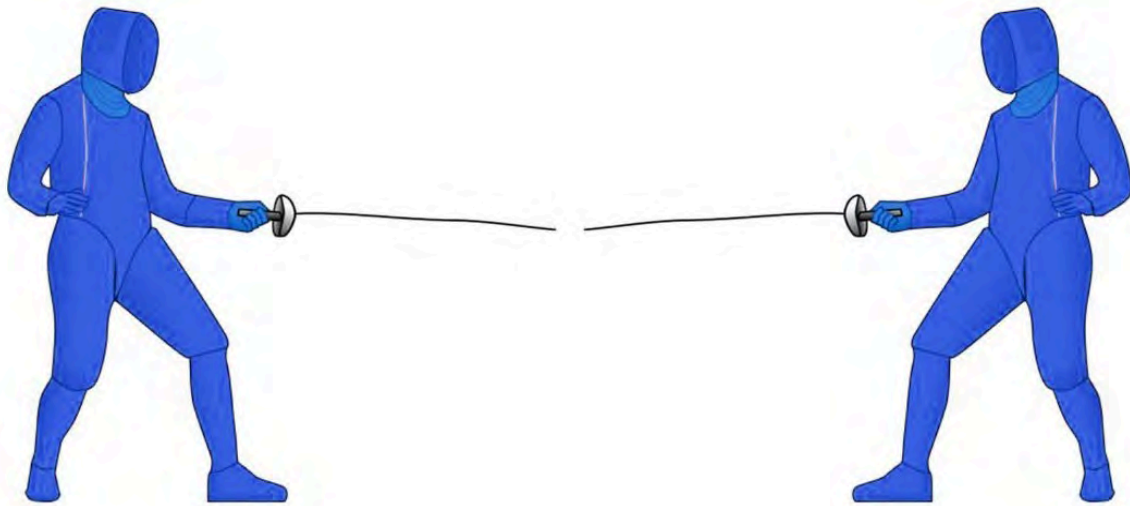

Figure 5 Valid target at épée

**t.98**

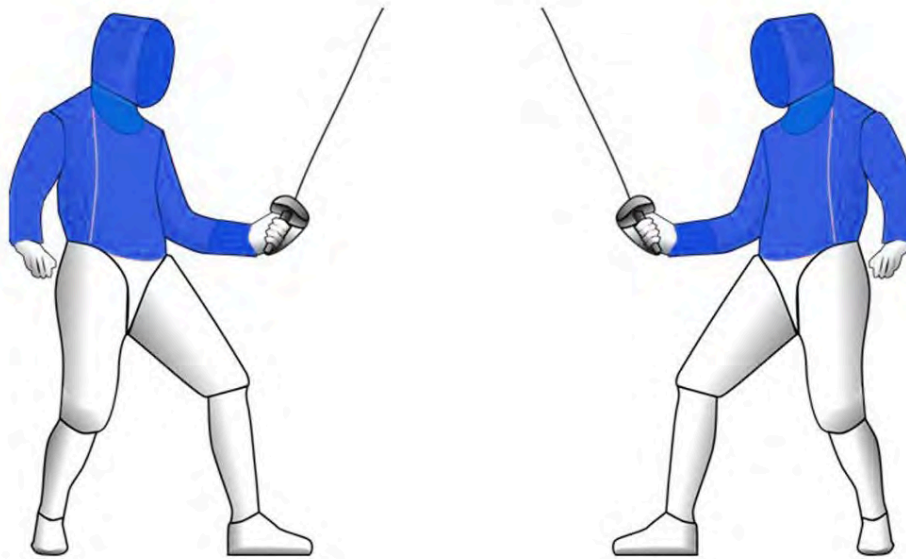

Figure 6 Valid target at sabre

**Opinion of the Refereeing Commission: in favour**

---

**Article: t.84**

**P.31**

**Proposal from: Refereeing Commission**

**Motivation:** in foil, it should be no difference between movement forward with step or step with legs crossing one another and follow by lunge and counted as an attack if it is correct executed when the straightening of the arm precedes the end of the step forward (without or with the legs crossing one another).\*

However continuous steps forward constitute a preparation.

**t.84**

3 Continuous steps forward, ~~with the legs crossing one another,~~ constitute a preparation and on this preparation any simple attack has priority.

\*This modification concerns English only.

**Opinion of the Refereeing Commission: in favour**

---

**Article:** t.97

**Proposal from:** Refereeing Commission

**Motivation:** Irrelevant as in sabre a hit on non-valid part of the target is not registered by the apparatus.

**t.97**

1 Only hits which arrive on the target are counted as valid.

The target comprises any part of the body above a horizontal line drawn between the top of the hip bones and then horizontally round the fencer's trunk (see Figure 6).

2 At sabre, it is forbidden to **protect** the target area or to **substitute** another part of the body for the target area, by covering it (cf. t.158-162, t.165, t.170); any hit scored by the fencer at fault is annulled.

a) If, during the fencing phrase, there is protection or substitution of a valid surface, the fencer at fault will be penalised as specified for offences of the 1st group (cf. also t.29).

~~b) If, during the fencing phrase, as a result of protection or substitution of a valid surface, a hit correctly given is registered as not valid, the fencer at fault will be penalized as specified for offences of the 1st group (cf. t.158-162, t.165, t.170) and the hit will be awarded.~~

**Opinion of the Refereeing Commission: in favour**

**Article:** t.109

**Proposal from:** Women and Fencing Council

**Motivation:**

- 1) To clarify the expectation on all participants in a competition to respect the FIE statutes and rules, including the Ethical Code and Safeguarding Policy.
- 2) To clarify the minimum reporting expectations if people witness a breach of the Ethical Code and Safeguarding Policy.

**t.109**

Everybody taking part in or present at a fencing competition **must respect the FIE statutes and rules, including but not limited to the FIE Ethical Code and Safeguarding Policy. They must remain orderly and must not disturb the smooth running of the competition.** During bouts no one is allowed to **go near the pistes**, to **give advice to the fencers**, to **criticise the Referee** or the judges, to insult them or to attempt to influence them in any way. Even the **team captain** must remain in the space assigned to him and he may only intervene in the situations and in the manner provided for in Article t.130 of the Rules. The Referee must stop immediately any activity which disturbs the smooth running of the bout which he is refereeing (cf. t.137.1-3). Any person who, for any reason, threatens or insults an official commits an offence of the 4th group and is penalised according to article t.169.

**Any person present who witnesses a breach of the FIE Ethical Code and the Safeguarding Policy must report this to the Directoire Technique.**

**Opinion of the Refereeing Commission: Not in favour**

**Article:** t.111

**Proposal from:** Women and Fencing Council

**Motivation:** To clarify that disturbing good order or smooth running can include failures to act in accordance with the FIE statutes, rules, Ethical Code and Safeguarding Policy.

**t.111**

The Referee and/or the Directoire Technique, on their own authority or at the request of an official delegate of the FIE or of the Organising Committee, can decide to expel from the competition venue, with or without a warning, any person who by his gestures, attitude, ~~or~~ language or failure to act in accordance with the FIE statutes, rules, Ethical Code and Safeguarding Policy, disturbs the good order or smooth running of the event.

**Opinion of the Refereeing Commission: Not in favour**

**Article:** t.124 and o.68

**Proposal from:** Rules Commission

**Motivation:** To have an initial ranking in competitions to separate unranked fencers.

**t.124**

#### Unwillingness to fight (Non-combativity)

##### 1 Individual events – Direct elimination

- c) When, for the third time, there is one minute of unwillingness to fight, a P-black card is awarded as follows:
  - i) If the scores of the two fencers are equal, the Referee sanctions the fencer with the lower initial seeding in the competition, which is based on the FIE ranking and by drawing lots among any fencers who are not in the ranking, with a P-Black card. The fencer with the higher initial seeding in the competition, which is based on the FIE ranking, wins the bout.

#### Composition of pools

**o.68**

- 1 The pools are composed taking account of the initial seeding in the competition, which is based on the latest official FIE ranking and by drawing lots among any fencers who are not in the ranking. The pools are composed using the following method:

**Opinion of the Refereeing Commission: in favour**

**Article: t.124**

**Proposal from: Refereeing Commission**

**Motivation:** remove part of table of penalties t.170 from t.124, as for all other Articles in the rules book connected to t.170 are no copies of the table in the text and this part of the table in text is not identic to the part in question in table t.170.

**t.124**

There is unwillingness to fight when there is one minute of fencing without a hit or without a hit scored off the target.

In the event of **unwillingness to fight**, the Referee will immediately call 'Halt!' as a decision of "fact" (cf.t.136.2).

Unwillingness to fight is sanctioned as follows:

0.5	<del>Unwillingness to fight: the sanctions imposed are shown by specific P-cards which are not cumulative with any other sanction awarded.</del>	t.124	1 <sup>st</sup> -time P- Yellow	2 <sup>nd</sup> -time P-Red	3 <sup>rd</sup> -time Penalisation
-----	--	-------	---------------------------------------	--------------------------------	---------------------------------------

**Opinion of the Refereeing Commission: in favour**

---

P.37

**Article: t.147**

**Proposal from: Rules Commission**

**Motivation:** add missing references to t.147

**t.147**

Although a competitor may in fact have hit his opponent on the target, **this hit may be disallowed**, either because it did not arrive during the period of time during which fencing is allowed, or because the competitor had crossed the boundaries of the piste, or because of defects in the electrical equipment, or because violence was involved in the making of the hit, or because of other reasons as laid down in the Rules (cf. t.25.2, t.27.2, t.28.2, t.29, t.33.2/4, t.35.3, t.44.2, t.56.1, t.73, t.79, t.80, t.89.2, t.93-4, t.94, t.95, t.96.3, t.97.2, t.99-1-2, t.101.5, t.106, t.121.2, t.137.2, t.161, t.170).

**Opinion of the Refereeing Commission:**

Not in favour to add more and more article number references and remove all of them as below

**t.147**

Although a competitor may in fact have hit his opponent on the target, **this hit may be disallowed**, either because it did not arrive during the period of time during which fencing is allowed, or because the competitor had crossed the boundaries of the piste, or because of defects in the electrical equipment, or because violence was involved in the making of the hit, or because of other reasons as laid down in the Rules. **(cf. t.25.2, t.27.2, t.28.2, t.29, t.33.2/4, t.35.3, t.44.2, t.56.1, t.73, t.79, t.80, t.89.2, t.93.1, t.94, t.95, t.96.3, t.97.2, t.99.1-2, t.101.5, t.106, t.121.2, t.137.2, t.161, t.170).**

**Article:** t.148

P. 38

**Proposal from:** Rules Commission

**Motivation:** add missing references to t.148

**t.148**

A competitor may have a hit awarded against him which he has not in fact received, either because he has crossed the rear limit of the piste (cf. t.34), or because he has committed an offence which has prevented his opponent fencing (a flèche attack which jostles the opponent, the use of the unarmed hand while fencing, etc.) (cf. **t.22.9, t.137.2, t.162.1/2, t.165, t.166, t.167.1, t.170, t.79.1.b, t.97.2.b, t.124.**)

**Opinion of the Refereeing Commission: Not in favour to add more and more articles number references and remove all of them as below**

**t.148**

A competitor may have a hit awarded against him which he has not in fact received, either because he has crossed the rear limit of the piste (cf. t.34), or because he has committed an offence which has prevented his opponent fencing (a flèche attack which jostles the opponent, the use of the unarmed hand while fencing, etc.) **(cf. t.22.9, t.137.2, t.162.1/2, t.165, t.166, t.167.1, t.170, t.79.1.b, t.97.2.b, t.124.)**

**Article:** t.170.1.16

P.39

**Proposal from:** Rules Commission

**Motivation:**

**Rationale:** t.56.10, touching during and after a fall, does not specify a yellow card sanction; however, intentionally falling to avoid the touch (\*) is sanctioned by a yellow card.

**t.170**

1.16

Irregular movements (*); hits made with violence <del>or during or after falling (*)</del> Intentional fall to avoid the hit (*)	t.121.2			
--	---------	--	--	--

Opinion of the Refereeing Commission: there is the same P.41 of Refereeing Commission

Articles: t.170.1.1, 1.4, 1.12, 2.1, 2.5, 2.6, 3.1, 3.4, 4.1, 4.5, 4.6, 4.8.

P.40

Proposal from: Rules Commission

Motivation: add missing references to t.170

Opinion of the Refereeing Commission: Not in favour with all references marked in yellow as they are not correct and add in 4.8 a text as in the rules book t.149.1

1st group		1st fault	2nd fault	3rd fault and following
1.1	Leaving piste without permission	t.23.6; t.120		
1.4	Covering/substitution of valid target (*)	t.29.2; t.30.1; t.79; t.97		
1.12	At sabre, hit made with the guard (*); any forward movement crossing the legs or feet (*)	t.96.3; t.101.5; t.121.2		

2nd group		1st fault	2nd fault	3rd fault and following
2.1	Use of non-sword arm/hand (*)	t.29.1; t.30		
2.5	Deliberate hit not on opponent (*)	t.55.3-2		
2.6	Dangerous, violent, or vindictive action, blow with guard or pommel (*)	t.121.2; t.26.1; t.147; t.149.1		

3rd group		1st time	2nd time
3.1	Fencer disturbing order when on the piste. In the most serious cases, the Referee may award a black card (t.168) immediately.	t.108.2; t.109; t.110; t.137.2; t.139.3	
3.4	Any person not on the pist disturbing good order. In the most serious cases, the Referee may award a black card immediately (t.168)	t.109; t.110; t.111; t.130; t.132.2; t.133; t.137.3/4; t.152; t.162.4; t.168	

4th group	PENALTIES (Cards)
-----------	-------------------



4.1	Fencer equipped with electronic communication equipment permitting him to receive communications during bout.	t. 64.6; <del>t.68</del> ; t.73.1.g	
4.5	Offence against sportsmanship.	t.121.2; t.122; t.123; <del>t.129</del> ; <del>t.144.2</del> ; t.149.1	
4.6	Refusal of a fencer to salute his opponent, the referee and the spectators before the beginning of the bout or after the last hit.	t.122; <del>t.145.2</del>	
4.8	<del>Deliberate Intentional * brutality</del> <b>violent or vindictive actions</b>	<del>t.26.1</del> ; t.149.1	

**Article:** t.170.0.5, 1.16 and 2.6

P.41

**Proposal from:** Refereeing Commission

**Motivation:** modification of t.170 in accordance with text of Technical rules book

a) proposal to modify as below

0.5	Unwillingness to fight: the sanctions imposed are shown by specific P-cards which are not cumulative with any other sanction awarded.	t.124	1 <sup>st</sup> time P- Yellow	2 <sup>nd</sup> time P-Red	3 <sup>rd</sup> time <del>Penalisation</del> P-Black
-----	---	-------	--------------------------------------	-------------------------------	--

Add text to 1.16 according to modification after Congress 2022 of t.121.2

1.16	Irregular movements on the piste (*); hits made with violence <del>or during or after falling (*)</del> Intentional fall to avoid the hit (*)	t.121.2			
------	---	---------	--	--	--

b) Remove article number t.149.1 from 2.6 as a penalty according to this article means “exclusion” and not fit to the red card penalties of the second group

c)	2nd group		1st offence	2nd offence	3rd offence and subseq.
2.1	Use of non-sword arm/hand *	T.29.1, t.30	RED	RED	RED
2.2	Demanding a break for medical reason deemed unjustified by doctor	T.45.3			
2.3	Absence of weapon control marks *	T.73.1a			
2.4					
2.5	Deliberate hit not on opponent *	t.55.3			

2.6	Dangerous, violent or vindictive action, blow with guard or pommel *	t.121.2, t.147, <del>t.149.4</del>			
-----	--	--	--	--	--

Opinion of the Refereeing Commission: in favour

Article: **t.170.3.4**

P. 42

Proposal from: Rules Commission

**Motivation:** Add to t.170 sanctions of the 3rd group, article t.110: smoking in competition halls. This practice is becoming more and more frequent with the appearance of electronic cigarettes.

3rd group		1 <sup>st</sup> time	2nd time
3.4	Any person not on piste disturbing the good order. <b>Smoking in the competition halls.</b> In the most serious cases, the Referee may award a black card immediately ( <del>t.168</del> ).	t.109; t.110; t.111; <del>t.130</del> ; <del>t.132.2</del> ; t.133; t.137.3/4; <del>t.152</del> ; <del>t.162.4</del> ; t.168	

Opinion of the Refereeing Commission: in favour for additional text, references numbers as in P.40 and for the first time “yellow card”



Proposals for the 2023 Congress  
Modifications of the Material Rules

The texts below are applicable on January 1st, 2024, unless mentioned otherwise.

---

P.46

**Article:** m.30.1

**Proposal from:** Refereeing Commission

**Motivation:** To make clear that foil and sabre masks cannot be used in epee events

**RULES SPECIFIC TO EPEE**

**Mask**

- m.30. 1.** The mask must not be covered, in whole or in part, by **conductive material or** material which can **cause the point to glance off** (cf. m.25).
- 2.** The mask must be so shaped that the **bib** reaches below the prominences of the collar bones (clavicles).

**Opinion of the Refereeing Commission: in favour**

---



## Proposals for the 2023 Congress

### Modifications of the Statutes

The texts below are applicable on January 1st, 2024, unless mentioned otherwise.

---

**Article: 4.4.2**  
**Proposal from: Legal Commission**

**P.6**

**Motivation:** Refine the conditions for candidature for election to the Refereeing Commission

A candidate for the Refereeing Commission must:

- be or have been an FIE category B or A referees in at least two weapons; and
- be a current member [or have already been a member](#) of the Refereeing Commission, or have refereed in official FIE competitions in at least two weapons in at least two (2) of the 4 fencing seasons (1 September to 31 August) preceding his candidature; and
- have refereed, at least once, in one weapon, in the table of [32/16](#) or eight [or](#) semi-final or final of the individual or team event of a senior World Cup, or a Grand Prix, or a World Championships or the Olympic Games of the 4 fencing seasons preceding his candidature [or have been part of the master list](#).

Being a member of the Refereeing Commission is incompatible with the national roles of technical director, referee, chief of delegation and team captain, [President](#), [Secretary General](#) or [member of the governing body of a National Federation](#). Once elected, the Refereeing Commission member shall send to the FIE head-office a letter of commitment signed by both the Refereeing Commission member and his/her national federation.

**Opinion of the Refereeing Commission: not in favour**

---

## FIE REFEREEING COMMISSION REPORT

<b>Date, place and time of the meeting:</b>	<b>18 July 2023, Milan, 09.00-18.00</b> <b>19 July 2023, Milan, 09.00-18.20</b> <b>20 July 2023, Milan, 09.00-16.20</b>
<b>Refereeing Commission :</b>	Irina Knysch Olga Cojocari Chang Gon Kim Marius Florea Khassoum Papa Toure Salah Ferjani Amgad Badawi Vladislav Shamis
<b>Online participants:</b>	Iana Dakova, via zoom, 18-20 July 2023 Jean-Marc Guenet, via zoom, 19-20 July 2023
FIE Interim President FIE Sport Director	Emmanuel Katsiadakis Dieter Lammer

### MEETING REPORT

1. Discussion and advises concerning rules for draw of referees and conflicts of interests, management of competitions by Refereeing Commission delegates during Olympic qualification.
2. Masterlist for the season 2023-24 was prepared until the middle of March 2024.
3. Reviewed and added the new videos for FIE exam in all weapons.
4. The proposals to the COMEX were discussed (attached).
5. Project of education program will be send to the FIE COMEX for confirmation.
6. Discussion about keeping confidentially all information of Refereeing Commission, not forward or disclose to any other person or third parties intern documents, proposals, discussions and opinions of Refereeing Commission members.
7. Referees seminar program and videos were prepared for the WCH Milan.
8. Preselection of best referees for the season 2022-23, final nomination will be done after World Championship 2023.
9. Preselection of referees for Olympic Games 2024 was done, the final nomination will be made after the World Championship 2023.

10. Refereeing delegates for the Veterans World Championship 2023 were nominated

Irina Knysch

Salah Ferjani

11. Refereeing delegates for Olympic Games 2024 were nominated as below by secret ballot by Refereeing Commission members who were presented in person at the meeting.

Irina Knysch

Olga Cojocari

Chang-Gon Kim

Amgad Badawi

Irina Knysch

President of FIE Refereeing Commission

**RAPPORT DE LA COMMISSION DES REGLEMENTS DE LA FIE**  
**FIE RULES COMMISSION REPORT**  
**INFORME DE LA COMISIÓN DE LOS REGLAMENTOS DE LA FIE**

<b>Date, lieu et heure de la réunion :</b> <b>Date, place and time of the meeting:</b> <b>Fecha, lugar y horario de la reunión:</b>	<b>7 et 8 juillet 2023 13:00 CET</b> <b>Virtual meeting</b>
<b>Participants:</b> <b>Participants:</b> <b>Participantes:</b>	<ol style="list-style-type: none"> <li>1. FERIANI Ziad (TUN) President</li> <li>2. BARLADEANU, Roxana – Mariana (ROU)</li> <li>3. CAFIERO Giuseppe (ITA)</li> <li>4. FARYABI Abbas Ali (IRI)</li> <li>5. KHDER Ahmed (EGY)</li> <li>6. KOEHLER Kelly (USA)</li> <li>7. LAMMER Dieter (GER)</li> <li>8. LAMON Janine (SUI)</li> </ol>
<b>Absences (indiquer si l'absence avait été annoncée) :</b> <b>Absent (indicate if the absence had been announced):</b> <b>Ausencias (indicar si la ausencia fue anunciada):</b>	<ol style="list-style-type: none"> <li>1. GARES Bruno (FRA) Representative of the Executive Committee in the Rules Commission (Present 8 Jul)</li> <li>2. BELMONTE Manuel (CAN), absence had been announced</li> <li>3. CRUZ Alberto (CRC) absence had been announced</li> </ol>

**INTRODUCTION**  
**INTRODUCTION**  
**INTRODUCCIÓN**

The President of the Commission welcomed all the members and moved to the agenda.

**RAPPORT DE LA RÉUNION**  
**MEETING REPORT**  
**INFORME DE LA REUNIÓN**

**Point 1 / Item 1 / Punto 1: Proposals for the Congress regarding the Statues**

**Proposal 7**, Article: 4.4.2 from: Legal Commission

**P. 7**

Opinion of the Rules Commission: **Not in favour**. The limitations are not necessary. The competence and the attitude should prevail on previous experience.

**Point 2 / Item 2 / Punto 2: Proposals for the Congress regarding the Organization Rules**

**Proposal 1**, Article: **o.10** from: Women and Fencing Council

**P. 1**

Opinion of the Rules Commission: **Not in favour**. The matter is already covered by the Administrative Rules.

There's nothing in our statutes or administrative rules to indicate that a council can make direct proposals for modifications in the rules (Statute 6A.5.3).

The function of councils is to suggest solutions to the Executive Committee to promote the objectives indicated in the statutes.

---

**Proposal 2**, Article: o.15 and o.85 from: Rules Commission

P. 2

Opinion of the Rules Commission: [In favour](#)

---

**Proposal 3**, Article: o.16 from: Women and Fencing Council

P. 3

**o.16**

Opinion of the Rules Commission: [Not in favour](#). The matter is already covered by the Administrative Rules.

---

**Proposal 4**, Article: o.18 from: Women and Fencing Council

P. 4

Opinion of the Rules Commission: [In favour](#).

---

**Proposal 5**, Article: o.25.3 from: Women and Fencing Council

P. 5

Opinion of the Rules Commission: [Not in favour](#). This information is already available in the results software.

---

**Proposal 6**, Article: o.26 from: Women and Fencing Council

P. 6

Opinion of the Rules Commission: [Not in favour](#). The matter is already covered by the Administrative Rules.



---

**Proposal 7**, Article: o.16, o.18, o.26, o.29, o.39, o.50, o.63, o.75, o.103, o.104

from: Rules Commission

P. 7

Opinion of the Rules Commission: [In favour](#).

---

**Proposal 8**, Article: o.29 and o.30 from: Rules Commission

**Motivation:** Rewrite the rule for a better understanding of its application. **Opinion of the Rules Commission:** [In favour](#).

P. 8

---

**Proposal 9**, Article: o.42 and o.102 from: Rules Commission

Opinion of the Rules Commission: [In favour](#).

P. 9

---

**Proposal 10**, Article: o.50 from: Veterans Council

Opinion of the Rules Commission: [Not in favour with the point 2 b](#)). There is always representative of the Veterans Council, named by the Veterans Council, in the Directoire Technique at Veteran World Championships.

[In favour with the other points](#).

P. 10

---

**Proposal 11**, Article: o.99 from: Rules Commission

Opinion of the Rules Commission: [In favour](#).

P. 11

---

**Proposal 12**, Article: o.100 from: Rules Commission

P.12

Opinion of the Rules Commission: [In favour.](#)

---

P.13

**Proposal 13**, Article: o.105 from: Rules Commission

Opinion of the Rules Commission: [In favour as modified:](#)

**Motivation** : the zone championships benefit from a coefficient of 1.5. **8** pistes must be equipped with video refereeing.

Senior zonal championships	T 64	T 16	4 8	T 1-8
----------------------------	------	------	-----	-------

P. 14

**Proposal 14**, Article: o.108 from: Rules Commission

**Motivation**: Add "Juniors" to the scale

Opinion of the Rules Commission: [In favour.](#)

---

P.15

**Proposal 15**, Article: o.109 from: Rules Commission

Opinion of the Rules Commission: [In favour.](#)

---

P.16

**Proposal 16**, Article: o.109 from: Rules Commission

Opinion of the Rules Commission: [In favour.](#)

---

P. 17

**Proposal 17**, Article: Table of contents from: Rules Commission

Opinion of the Rules Commission: [In favour](#) after correction of the numbering  
[\(PART C E - VETERANS\)](#).

---

P. 18

**Proposal 18**, Article: Index to Articles- from: Rules Commission

Opinion of the Rules Commission: [In favour](#)

---

**Point 3 /Item 3 / Punto 3: Proposals for the Congress regarding the Technical Rules**

---

**Proposal 19**, Article: t.18 from: Rules Commission

P. 19

Opinion of the Rules Commission: [Proposal deleted.](#)

---

**Proposal 20**, Article: t.18.2 from: SEMI Commission

P.20

Opinion of the Rules Commission: [In favour.](#)

---

**Proposal 21**, Article: t.23, t.25, t.26, t.27, t.29, t.35, t.43, t.45, t.55, t.71, t.73, t.76, t.90,  
t.96, t.110, t.116, t.120, t.123, t.125, t.128, t.133, t.172 from: Rules Commission

P.21

Opinion of the Rules Commission: [In favour.](#)

---

P.22

**Proposal 22**, Article: t.35 from: Rules Commission

Opinion of the Rules Commission: [In favour](#).

---

**Proposal 23**, Article: t.41 from: Rules Commission

P.23

Opinion of the Rules Commission: [In favour](#),

with a new correction:

1 The first two opponents fence until one **or both of them** have scored five hits, within the time limit of 3 minutes.

The next two opponents fence until one **or both\*** of their scores has reached ten hits, within the time limit of 3 minutes, and so on with successive bouts, cumulatively, of five hits.

(\*Correction valid only in English).

---

**Proposal 24**, Article: t.45 from: Rules Commission

P.24

Opinion of the Rules Commission: [In favour](#).

---

**Proposal 25**, Article: t.56.3 from: Refereeing Commission

P.25

Opinion of the Rules Commission: [In favour](#).

---

**Proposal 26**, Article: t.56 and t. 170 from: Refereeing Commission

P.26

Opinion of the Rules Commission: [In favour](#).

---

**Proposal 27**, Article: t.61 from: Rules Commission

- pools, ~~one possible appeal during each bout~~;  
only in the zonal qualifying event for the Olympic Games is video refereeing compulsory in the pools. The fencer has only one possibility of appeal in each period.
- in **direct elimination bouts**, two possible appeals.  
Should **the referee agree with the fencer** who appealed for the video-refereeing, the latter is entitled to retain the right of appeal.

Opinion of the Rules Commission: **In favour with the proposed modification.**

- in pools, **one possible appeal during each bout**; ( Cf. O.105, zonal qualification for Olympic Games).

~~only in the zonal qualifying event for the Olympic Games is video refereeing compulsory in the pools. The fencer has only one possibility of appeal in each period.~~

---

**Proposal 28**, Article: t.64 and t.170.4.1 from: Fencing Federation of Jamaica

Opinion of the Rules Commission: **Not in favour.**

---

**Proposal 29**, Article: t.70 from: Rules Commission

**Non-standard equipment**

**t.70**

In whatever circumstances a fencer on the piste is found to be in possession of equipment which is **non-regulation or defective** (cf.m.8, m.9, m.11, m.12, m.13, m.16, m.17, m.23), the referee confiscates the equipment and submits it to the experts on duty for examination. The equipment in question will only be returned to the owner after the measures necessitated by this examination have been completed and, if appropriate, after the payment of any expenses for repairs. The equipment must be rechecked before it is used again.

Opinion of the Rules Commission: **In favour, with the proposed modification.**

In whatever circumstances a fencer on the piste is found to be in possession of equipment which is **non-regulation or defective** (cf.m.8, m.9, m.11, m.12, m.13, m.16, m.17, m.23) **according to Material Rules**), the referee confiscates the equipment and submits it to the experts on duty for

examination. The equipment in question will only be returned to the owner after the measures necessitated by this examination have been completed and, if appropriate, after the payment of any expenses for repairs. The equipment must be rechecked before it is used again.

---

**Proposal 30**, Article: t.77, t.91 and t.98 from: Rules Commission

P.30

Opinion of the Rules Commission: [In favour](#).

---

**Proposal 31**, Article: t.84 from: Refereeing Commission

P.31

Opinion of the Rules Commission: [Not in favour](#).

**We can't modify a convention with a simple proposal, this is not the correct procedure, we propose to create a working group with members of the Coaches' Council, Athletes' Commission, Refereeing Commission and Rules Commission. As the FIE has done in the past for sabre, the working group conducted tests during competitions.**

---

**Proposal 32**, Article: t.97 from: Refereeing Commission

P.32

Opinion of the Rules Commission: [In favour](#).

---

**Proposal 33**, Article: t.109 from: Women and Fencing Council

P.33

Opinion of the Rules Commission: [Not in favour](#). **Because this matter is already covered by the FIE Ethical Code and the Safeguarding Policy.**

---

**Proposal 34**, Article: t.111 from: Women and Fencing Council

P.34

Opinion of the Rules Commission: [Not in favour](#). The matter concerns the Statutes.

---

**Proposal 35**, Article: t.124 and o.68 from: Rules Commission

P.35

Opinion of the Rules Commission: [In favour](#).

---

**Proposal 36**, Article: t.124 from: Refereeing Commission

P.36

Opinion of the Rules Commission: [In favour](#).

---

**Proposal 37**, Article: t.147 from: Rules Commission

P.37

**t.147**

Although a competitor may in fact have hit his opponent on the target, **this hit may be disallowed**, either because it did not arrive during the period of time during which fencing is allowed, or because the competitor had crossed the boundaries of the piste, or because of defects in the electrical equipment, or because violence was involved in the making of the hit, or because of other reasons as laid down in the Rules (cf. [t.25.2](#), [t.27.2](#), [t.28.2](#), [t.29](#), [t.33.2/4](#), [t.35.3](#), [t.44.2](#), [t.56.1](#), [t.73](#), [t.79](#), [t.80](#), [t.89.2](#), [t.93.1](#), [t.94](#), [t.95](#), [t.96.3](#), [t.97.2](#), [t.99.1-2](#), [t.101.5](#), [t.106](#), [t.121.2](#), [t.137.2](#), [t.161](#), [t.170](#)).

Opinion of the Rules Commission: [In favour](#), with the proposed modifications.

Although a competitor may in fact have hit his opponent on the target, **this hit may be disallowed**, either because it did not arrive during the period of time during which fencing is allowed, or because the competitor had crossed the boundaries of the piste, or because of defects in the electrical equipment, or because violence was involved in the making of the hit, or because of other reasons as laid down in the Rules ([cf. t.25.2, t.27.2, t.28.2, t.29, t.33.2/4, t.35.3, t.44.2, t.56.1, t.73, t.79, t.80, t.89.2, t.93.1, t.94, t.95, t.96.3, t.97.2, t.99.1-2, t.101.5, t.106, t.121.2, t.137.2, t.161, t.170](#)) **in accordance with the Technical Rules.**

---

**Proposal 38, Article: t.148 from: Rules Commission**

P. 38

**t.148**

A competitor may have a hit awarded against him which he has not in fact received, either because he has crossed the rear limit of the piste (cf. t.34), or because he has committed an offence which has prevented his opponent fencing (a flèche attack which jostles the opponent, the use of the unarmed hand while fencing, etc.) (cf. [t.22.9](#), [t.137.2](#), [t.162.1/2](#), [t.165](#), [t.166](#), [t.167.1](#), [t.170](#), [t.79.1.b](#), [t.97.2.b](#), [t.124.](#))

**Opinion of the Rules Commission: [In favour](#), with the proposed modification**

A competitor may have a hit awarded against him which he has not in fact received, either because he has crossed the rear limit of the piste (cf. t.34), or because he has committed an offence which has prevented his opponent fencing (a flèche attack which jostles the opponent, the use of the unarmed hand while fencing, etc.) ([cf. t.22.9, t.137.2, t.162.1/2, t.165, t.166, t.167.1, t.170, t.79.1.b, t.97.2.b, t.124.](#) [in accordance with the Technical Rules.](#))

P.39

**Proposal 39, Article: t.170.1.16 from: Rules Commission**

**Opinion of the Rules Commission: [In favour](#).**

P.40

**Proposal 40, Articles: t.170. 1.1, 1.4, 1.12, 2.1, 2.5, 2.6, 3.1, 3.4, 4.1, 4.5, 4.6, 4.8.**

**from: Rules Commission**

**Motivation:** add missing references to t.170

1st group		1st fault	2nd fault	3rd fault and following
1.1	Leaving piste without permission	<a href="#">t.23.6</a> ; <a href="#">t.120</a>		
1.4	Covering/substitution of valid target (*)	<a href="#">t.29.2</a> ; <a href="#">t.30.1</a> ; <a href="#">t.79</a> ; <a href="#">t.97</a>		
1.12	At sabre, hit made with the guard (*); any forward movement crossing the legs or feet (*)	<a href="#">t.96.3</a> ; <a href="#">t.101.5</a> ; <a href="#">t.121.2</a>		



2nd group		1st fault	2nd fault	3rd fault and following
2.1	Use of non-sword arm/hand (*)	t.29. <del>1</del> ; t.30		
2.5	Deliberate hit not on opponent (*)	t.55. <del>3-2</del>		
2.6	Dangerous, violent, or vindictive action, blow with guard or pommel (*)	t.121.2; t.26.1; t.147; t.149.1		

3rd group		1st time	2nd time
3.1	Fencer disturbing order when on the piste. In the most serious cases, the Referee may award a black card (t.168) immediately.	t.108.2; t.109; t.110; t.137.2; t.139.3	
3.4	Any person not on the pist disturbing good order. In the most serious cases, the Referee may award a black card immediately (t.168).	t.109; t.110; t.111; t.130; t.132.2; t.133; t.137.3/4; t.152; t.162.4; t.168	

4th group		PENALTIES (Cards)
4.1	Fencer equipped with electronic communication equipment permitting him to receive communications during bout.	t. 64.6; <del>t.68</del> ; t.73.1.g
4.5	Offence against sportsmanship.	t.121.2; t.122; t.123; t.129; t.144.2; t.149.1
4.6	Refusal of a fencer to salute his opponent, the referee and the spectators before the beginning of the bout or after the last hit.	t.122; t.145.2
4.8	<del>Deliberate-Intentional</del> * brutality	t.26.1; t.149.1

\*This modification concerns English version only.

Opinion of the Rules Commission: In favour, with the proposed modifications

1st group		1st fault	2nd fault	3rd fault and following
1.1	Leaving piste without permission	t.23.6; t.120		
1.4	Covering/substitution of valid target (*)	t.29.2; t.30.1; t.79; t.97		
1.12	At sabre, hit made with the guard (*); any forward movement crossing the legs or feet (*)	t.96.3; t.101.5; t.121.2		

2nd group		1st fault	2nd fault	3rd fault and following
2.1	Use of non-sword arm/hand (*)	t.29.4; t.30		
2.5	Deliberate hit not on opponent (*)	t.55.3-2		
2.6	Dangerous, violent, or vindictive action, blow with guard or pommel (*)	t.121.2; t.26.1; t.147; t.149.1		

3rd group		1st time	2nd time
3.1	Fencer disturbing order when on the piste. In the most serious cases, the Referee may award a black card (t.168) immediately.	t.108.2; t.109; t.110; t.137.2; t.139.3	
3.4	Any person not on the pist disturbing good order. In the most serious cases, the Referee may award a black card immediately (t.168).	t.109; t.110; t.111; t.130; t.132.2; t.133; t.137.3/4; t.152; t.162.4; t.168	

4th group		PENALTIES (Cards)
4.1	Fencer equipped with electronic communication equipment permitting him to receive communications during bout.	t. 64.6; t.68; t.73.1.g
4.5	Offence against sportsmanship.	t.121.2; t.122; t.123; t.129; t.144.2; t.149.1
4.6	Refusal of a fencer to salute his opponent, the referee and the spectators before the beginning of the bout or after the last hit.	t.122; t.145.2
4.8	<del>Deliberate</del> -Intentional brutality *	t.26.1; t.149.1

\*This modification concerns English version only.

**Proposal 41**, Article: t.170.0.5, 1.16 and 2.6 from: Refereeing Commission.

P.41

Opinion of the Rules Commission: [In favour](#).

**Proposal 42**, Article: t.170.3.4 from: Rules Commission

P. 42

3rd group		1st time	2nd time
3.4	Any person not on piste disturbing the good order. <a href="#">Smoking in the competition halls</a> . In the most serious cases, the Referee may award a black card immediately (t.168).	t.109; t.110; t.111; t.130; t.132.2; t.133; t.137.3/4; t.152; t.162.4; t.168	

Opinion of the Rules Commission: [In favour](#), with the proposed modification

3rd group		1st time	2nd time
3.4	Any person not on piste disturbing the good order, <a href="#">including smoking in the competition halls including electronic cigarettes</a> . In the most serious cases, the Referee may award a black card immediately ( <del>t.168</del> ).	t.109; t.110; t.111; <del>t.130; t.132.2</del> ; t.133; t.137.3/4; <del>t.152; t.162.4</del> ; t.168	

**Proposal 43**, Article: t.170.3.6 from: Rules Commission

P.43

Opinion of the Rules Commission: [In favour](#).

**Proposal 44**, Article: Technical Index to articles from: Rules Commission

P.44

Opinion of the Rules Commission: [In favour.](#)

---

**Point 4 /Item 4 / Punto 4: Proposals for the Congress regarding the Material Rules**

**Proposal 45**, Article: m.25.3.h from: SEMI Commission

P.45

**m.25.3.h**

A World Champion has the right to have his/her name and the abbreviation of his/her national federation printed in red [for the following season.](#)

An Olympic Champion has the right to have his/her name and the abbreviation of his/her national federation printed in gold.

Opinion of the Rules Commission: [In favour, with the proposed modification](#)

An Olympic Champion has the right to have his/her name and the abbreviation of his/her national federation printed in gold [until the end of the next Olympic Games.](#)

---

P.46

**Proposal 46**, Article: m.30.1 from: Refereeing Commission

Opinion of the Rules Commission: [In favour.](#)

---

P. 47

**Proposal 47**, Article: Annex A 4 Label of quality, Material Rules (see Urgent letter 2/2022)

from: SEMI Commission - deferred proposal from the 2022 Congress

~~2. Chip and label installation requirements.~~

~~Page 80~~

~~From 01.03.2021, the obligatory chipping of new fencing equipment (jacket, trousers, plastron mask) has been introduced. It will be mandatory from 01.01.2023.~~

~~Both variants of the FIE seal of quality are acceptable up to and including the 2026/2027 2025/2026 season.~~

~~For the 2027/2028 2026/2027 season, masks, jackets, breeches and plastrons must have the new quality seal with a chip securely located underneath.~~

Cancellation of the text while waiting for a new system.

Opinion of the Rules Commission: **Cancelled while waiting for a new system.**

---

**Proposal 48**, Article: Annex A, 4.4 from: SEMI Commission

P.48

Opinion of the Rules Commission: In favour.

---

**RAPPORT DE LA COMMISSION SEMI DE LA FIE**  
**FIE SEMI COMMISSION REPORT**  
**INFORME DE LA COMISIÓN SEMI DE LA FIE**

<b>Date, lieu et heure de la réunion :</b> <b>Date, place and time of the meeting:</b> <b>Fecha, lugar y horario de la reunión:</b>	<b>7 July 2023 1.00 CET VIDEO</b> <b>8 July 2023 1.00 CET VIDEO</b>
<b>Participants:</b> <b>Participants:</b> <b>Participantes:</b>	<ol style="list-style-type: none"> <li>1. Donald ANTHONY JR</li> <li>2. Giandomenico VARALLO</li> <li>3. Baiba BRANDULE</li> <li>4. Luis Alberto CRUZ</li> <li>5. Maria Wilda EBERL LOPEZ</li> <li>6. Gudjon Ingi GESTSSON</li> <li>7. Islam Bilel HADI</li> <li>8. Samer HASHEM</li> <li>9. Zhingang HOU</li> <li>10. Janet HUGGINS</li> <li>11. Zeyad SALEEM</li> </ol>
<b>Absences (indiquer si l'absence avait été annoncée) :</b> <b>Absent (indicate if the absence had been announced):</b> <b>Ausencias (indicar si la ausencia fue anunciada):</b>	NONE

**INTRODUCTION**  
**INTRODUCTION**  
**INTRODUCCIÓN**

Meeting opened by Donald Anthony Jr and Giandomenico Varallo

**RAPPORT DE LA RÉUNION**  
**MEETING REPORT**  
**INFORME DE LA REUNIÓN**

**Point 1 / Item 1 / Punto 1:**

Designation of the SEMI member appointed for the next season

Olympic Games	Giandomenico Varallo	Janet Huggins	Gudjon Getsson
Junior and Cadet World Championships	Biba Brandule	Samer Hashem	Zeyad Saleem
Veteran World Championships	Luis Alberto Cruz		

If a second SEMI is permitted by Comex Maria Wilda EBERL LOPEZ

**Point 2 / Item 2 / Punto 2:**

Proposals concerning the Statutes

Decisions of the SEMI shown on separate document

**Point 3 / Item 3 / Punto 3:**

Proposals concerning the Rule books

Decisions of the SEMI shown on separate document

#### **Point 4 / Item 4 / Punto 4:**

Proposals from SEMI for congress 2024.

Giandomenico Varallo asked if anyone had any proposals for congress 2024. None were forthcoming. Proposals should be made by mid- March 2024 another meeting can be arranged in February 2024 to discuss any proposals.

#### **Point 5 / Item 5 / Punto 5:**

Report of the Junior and Cadet World Championships in Plovdiv.

Report given by Gudjon Gestsson

1. No bags were available to transport fencers equipment from the call room to the piste
2. Use of volunteers in weapon control room and call room. The volunteers were rotated frequently so every new group of volunteers had to be trained each time.
3. Due to inexperience of volunteers in weapon control some items that did not comply were passed in error.

NOTES and suggestions

1. It would be helpful if further training of Weapon Control and Call Room Staff was made available. This would considerably reduce waiting times for the fencers and improve the running of the event.
2. At major events at least 4 lines of controls should be set up
3. Not all countries have the necessary sets of test equipment. Each test line would require (Gabarit for dimensions and flexibility/Electrical resistance testers for controlling lame material and blades)
4. Would it be possible for the FIE to budget for the provision of 2 complete sets for use by countries running competitions.

#### **Point 6 / Item 6 / Punto 6:**

##### **Flexibility of the blades**

It has been observed that some foil blades have been produced are failing as being too stiff.

At the recent European Games, a large proportion of foil blades tested failed for this reason (26%) these were almost all manufactured by Blaise Frères (BF). A further 15 brand new BF unsold blades (the stock of a local retailer) were tested and 7 failed. A report by the European SEMI was sent to FIE SEMI for information.

Giandomenico Varallo has spoken to the owner of BF on many occasions and has been told that they are being manufactured at the request of fencers who like the stiffer blades. However, these blades fall outside the parameters set in the FIE Rules.

A further check on the stiffness of foil blades will be made at the forthcoming World Championships in Milan and details of failures will be noted.

To ensure that blades are produced within the permitted limits Giandomenico Varallo may need to take further action which could result in withdrawing homologation.

It is essential that blades that are too stiff should not be used for safety reasons.

#### **Point 7 / Item 7 / Punto 7:**

##### **Advertising and checks by the SEMI Commission**

A great amount of time is taken up in weapon control explaining to fencers with equipment failures due to infringement against the publicity code. It would be useful if a member of the Promotion Communication and Marketing Commission could be available in the weapon control at major events to deal with these cases

A request was made for a joint meeting with SEMI – PCM – ATHLETS to discuss how this could work and to help educate fencers in what is permitted (suggested a diagram of the athlete showing permitted positions and size.)

**Point 8 / Item 8 / Punto 8:**

Any other business

A. Maraging sabre blades

Solution not yet reached but 2 manufacturers have sabre blades at the development stage

B. Revision of FIE Material Rules

The text has been translated from English to French and 20 points need clarification for the translation. As Janet Huggins and Giandomenico Varallo are both scheduled to be at the World Championships in Milan in July they will meet to confirm any required alterations. When finished the completed PDF and the XL sheet will be sent out to the members of the SEMI.

C. WIRELESS SYSTEM and its use at the Paris Olympics.

The present wireless system from StM does not meet the European (and USA) Regulations  
The requirement to cancel out the signal from the metallic piste cannot be obtained within permitted levels. StM must provide a successful test of their system if it is to be used at the Olympics

An alternative system is being investigated whilst using conventional spools and wires but incorporating lights in the fencer's masks.

This system has the following properties

Reduction in the sound made by the spool and wires for TV

Signal from score machine to light in mask 5mili seconds via encrypted radio transmitter signal  
cCompatible with Swiss Timing protocol with a battery life 48hrs about.

A test of this system is expected at the World Championships in Milan

D. New manufacturers from China

Zhigang Hou was asked to assist with education of these companies regarding the specification of equipment specifications. A suggestion was made that he could attempt as translation of the material rules into Chinese.

A similar idea was raised by Samer Hashem and Zeyad Saleem regarding the possible translation of the rules into Arabic.

Giandomenico Varallo

Janet Huggins

.....July 2023

10<sup>th</sup> July 2023





**Proposals for the 2023 Congress**  
**Modifications of the Organisation Rules**

The texts below are applicable on January 1st, 2024, unless mentioned otherwise.

---

P. 2

**Article:** o.15 and o.85

**Proposal from:** Rules Commission

**Motivation:** Group the procedure for uploading and publishing registration files o.85.1 in o.15.5. This proposal concerns the procedure and the responsibility of the DT.

*FIE Directoire Technique and delegates for official events*

**o.15**

- 5 The day before an individual or team competition, the DT must download the entry file, the day before the competition, from 12:00 noon local time from the FIE website.
  - In individual competitions, the DT must publish and send to the FIE the pools and the relevant schedules, as well as the list of exempt fencers for senior competitions, no later than 4:00 p.m. (local time). No addition may be made to pools already published unless they come from pools starting at the same time (cf o.67.1).
  - In team competitions, the DT must publish and send to the FIE the table and the relevant schedules no later than one hour after the end of the quarter finals of the individual event. No addition may be made to the published list.

**o.85**

- 1 The competition consists of **two phases**, a preliminary phase and a main phase, each of which are run on one day.
- ~~2 The day before the competition, the organizers must publish and send to the FIE the pools and relevant schedules, as well as the list of exempt fencers, at the latest by 4:00 pm (local~~

~~time). To do so, they must download the entry file from the FIE web site the day before the competition at or after 12h00, local time. No addition may be made to pools already published unless they come from pools starting at the same time (cf o.67.1).~~

**3 2** The **16 fencers entered who are ranked highest in the most recent official FIE classification** are exempt from the preliminary phase.

**4 3** **Should a fencer who has been entered not turn up, a fine (cf o.31**, table of financial penalties and fines), payable to the FIE, is inflicted on the Federation of the fencer at fault except in a case of force majeure which is duly justified.

**5 4** **In the case of a tie** in the official FIE ranking between two or more fencers for the 16th exempt place, lots are drawn to decide which of these fencers will benefit from exemption from the preliminary phase.

**Opinion of the SEMI Commission: IN FAVOUR**

P. 4

**Article:** o.18

**Proposal from:** Women and Fencing Council

**Motivation:**

Advance gender equality in refereeing, SEMI and medical delegates, to assist in the development of more females in all roles in fencing and to ensure that both genders have representation.

Demonstrate the FIE's commitment to the IOC objective to advance gender equality in all aspects of Olympic sport and help ensure that the FIE are able to meet the gender representation quotas for participation in the Olympics.

**o.18**

Designation of refereeing, SEMI, and medical delegates

Refereeing delegates must be members of the FIE Refereeing Commission. SEMI delegates must be members of the FIE SEMI Commission.

Medical delegates must be **a** members of the FIE Medical Commission.

1. World Championships

A chief Refereeing delegate and 5 more Refereeing delegates, a chief SEMI delegate and 2 more SEMI delegates and **3** Medical delegates are appointed by the FIE Executive Committee following the recommendations of the respective commissions. **Across all the delegates there must be at least 30% of Refereeing delegates and at least one of SEMI and medical delegates from each gender.**

2. Grands Prix

Two Refereeing delegates are appointed by the Executive Committee following the recommendation of the Refereeing Commission. **There must be a minimum representation of at least 20% of each gender when all Grand Prix appointments across all weapons are considered together.**

3. Senior World Cup competitions  
One Refereeing delegate is appointed by the Executive Committee following the recommendation of the Refereeing Commission. **There must be a minimum representation of at least 20% of each gender when all Senior World Cup appointments across all weapons are considered together.**

4. Veterans World Championships  
Two Refereeing delegates, one SEMI delegate and two Medical delegates are appointed by the FIE Executive Committee following the recommendations of the respective commissions. **There must be at least one delegate from each gender within the total of 5 appointments.**

**Opinion of the SEMI Commission: IN FAVOUR**

**In view of the increase in size of the Veteran World Championships a second SEMI Delegate should be appointed and consideration also be given to a SEMI Delegate for Grande Prix events**

P. 7

**Article:** o.16, o.18, o.26, o.29, o.39, o.50, o.63, o.75, o.103, o.104

**Proposal from:** Rules Commission

**Motivation:** Creation of new Veterans chapters.

**o.16**

~~3— Veterans World Championships~~

~~The Directoire Technique is composed of four members of different nationalities, one of whom must represent the country where the competition is held.~~

**o.18**

~~4— Veterans World Championships~~

~~Two Refereeing delegates, one SEMI delegate and two Medical delegates are appointed by the FIE Executive Committee following the recommendations of the respective commissions.~~

**o.26**

- ~~1.— Refereeing at Veteran World Championships is carried out by referees appointed by the Executive Committee of the FIE, selected by the Refereeing Commission on indication of the Organizing Committee and Veterans Council.~~

~~Referees must attend the refereeing meeting that takes place the day before the World Championships~~

~~2~~

For **Senior World Cup, Grands Prix and World Cup team competitions**, 8 referees, proposed by the Refereeing Commission, will be designated by the Executive Committee and delegations will not have to provide any referees. The additional referees required (not less than 5) will be provided by the organising committee. **All the referees will be at the expense of the organisers who in return will keep the entry fees.**

**o.29**

~~6)The age groups in veteran competitions are:~~

- ~~a) Age group 50-59: Must be at least 50 years old and less than 60 years old in the year of the competition.~~
  - ~~b) Age group 60-69: Must be at least 60 years old and less than 70 years old in the year of the competition.~~
  - ~~c) Age group 70+: Must be at least 70 years old in the year of the competition.~~
- 

~~6—The age groups in veteran competitions are:~~

- ~~a) Age group 40-49: Must be at least 40 years old and less than 50 years old in the year of the competition.~~
- ~~b) Age group 50-59: Must be at least 50 years old and less than 60 years old in the year of the competition.~~
- ~~c) Age group 60-69: Must be at least 60 years old and less than 70 years old in the year of the competition.~~
- ~~d) Age group 70+: Must be at least 70 years old in the year of the competition.~~

~~Application : during the test at the 2025 World Championships (not applicable in 2023 and 2024).~~

---

## **VETERAN WORLD CHAMPIONSHIPS**

### **o.39**

- ~~1—The programme of the Veteran World Fencing Championships comprises twenty-four events, eighteen individual—three categories for each weapon—and six team—male foil, female foil, male epee, female epee, male sabre and female sabre. The programme must be arranged in such a way as to allow any fencer to participate in all weapons. Team events must be held on the day following the last championship of the three categories of each weapon.~~
- ~~2—No changes of dates are allowed for any competition, after the release of the programme.~~
- ~~3—Each competition must be held in one single day, avoiding long periods of inactivity.~~

### **o.39**

- ~~1—The programme of the Veteran World Fencing Championships comprises thirty-six events, twenty-four individual—four categories for each weapon—and twelve team—male foil, female foil, male epee, female epee, male sabre and female sabre (two categories for each weapon and gender). The programme must be arranged in such a way as to allow any fencer to participate in all weapons. Team events must be held on the day following the last championship of the corresponding two individual categories of each weapon.~~
- ~~2—No changes of dates are allowed for any competition, after the release of the programme.~~

~~3—Each competition must be held in one single day, except for team events for which the round of pools may be achieved the day before direct elimination avoiding long periods of inactivity.~~

~~Application: during the test at the 2025 World Championships (not applicable in 2023 and 2024).~~

---

## **Veterans**

### **o.50**

~~1—Any proposed candidature for organising the Veteran World Championships must be studied at the venue concerned by an ad hoc delegation designated by the Executive Committee, at the invitation of the candidate federation.~~

~~2—The organising committee, who will receive all the entry fees from the participating delegations, must, at their own expense, invite the following international officials (tourist-class return air fare, accommodation and daily allowances):~~

~~a) The President of the FIE or his representative, who presides over the World Championships and, in particular, controls the smooth running of the Directoire Technique.~~

~~b) Four members of the Directoire Technique appointed by the Executive Committee of the FIE, one of whom must belong to the organising country.~~

~~c) One member of the SEMI Committee, appointed by the Executive Committee of the FIE.~~

~~d) One member of the Refereeing Committee, appointed by the Executive Committee of the FIE.~~

~~e) Two members of the Medical Committee, appointed by the Executive Committee of the FIE.~~

~~f) The referees appointed by the Executive Committee of the FIE.~~

~~The officials a) to e) should preferably be selected from the Zone in which the Championships are being held.~~

## ***Entries to competitions***

### **o.63**

~~1—Entries must be sent to the organisers by the competitors' national federation. Entries must be sent not later than one month before the beginning of the championships.~~

~~2—However, up to two days before the competition at noon (local time), fencers may be added by their national federation after payment to the Organizing Committee of a penalty equal to 100 % of the registration fee.~~

~~3—Entries for team championships must be forwarded to the Directoire Technique not later than 4.00 pm (local time) of the day before the competition.~~

~~4—At the Veterans World Championships, entries for the individual events are limited to four fencers in each category per gender, per weapon and per nation. The names must be the same as those on the FIE licences.~~

## Composition of the pools for Veteran individual championships

### o.75

The pools are composed taking into account the following orders of strength:

1. The fencers ranked from the addition of the results in the previous two years Championships, irrespective of age category changes. Scores are awarded according to the following table:

<u>1st place 80 points</u>	<u>31th place 7 points</u>	<u>61th place 3,2 points</u>
<u>2nd place 65 points</u>	<u>32th place 6,5 points</u>	<u>62th place 3,1 points</u>
<u>3rd place ex aequo 50 points</u>	<u>33th place 6 points</u>	<u>63th place 3 points</u>
<u>5th place 38 points</u>	<u>34th place 5,9 points</u>	<u>64th place 2,9 points</u>
<u>6th place 36 points</u>	<u>35th place 5,8 points</u>	<u>65th place 2,8 points</u>
<u>7th place 34 points</u>	<u>36th place 5,7 points</u>	<u>66th place 2,7 points</u>
<u>8th place 32 points</u>	<u>37th place 5,6 points</u>	<u>67th place 2,6 points</u>
<u>9th place 30 points</u>	<u>38th place 5,5 points</u>	<u>68th place 2,5 points</u>
<u>10th place 28 points</u>	<u>39th place 5,4 points</u>	<u>69th place 2,4 points</u>
<u>11th place 26 points</u>	<u>40th place 5,3 points</u>	<u>70th place 2,3 points</u>
<u>12th place 24 points</u>	<u>41th place 5,2 points</u>	<u>71th place 2,2 points</u>
<u>13th place 22 points</u>	<u>42th place 5,1 points</u>	<u>72th place 2,1 points</u>
<u>14th place 20 points</u>	<u>43th place 5 points</u>	<u>73th place 2 points</u>
<u>15th place 18 points</u>	<u>44th place 4,9 points</u>	<u>74th place 1,9 points</u>
<u>16th place 16 points</u>	<u>45th place 4,8 points</u>	<u>75th place 1,8 points</u>
<u>17th place 14 points</u>	<u>46th place 4,7 points</u>	<u>76th place 1,7 points</u>
<u>18th place 13,5 points</u>	<u>47th place 4,6 points</u>	<u>77th place 1,6 points</u>
<u>19th place 13 points</u>	<u>48th place 4,5 points</u>	<u>78th place 1,5 points</u>
<u>20th place 12,5 points</u>	<u>49th place 4,4 points</u>	<u>79th place 1,4 points</u>
<u>21th place 12 points</u>	<u>50th place 4,3 points</u>	<u>80th place 1,3 points</u>
<u>22th place 11,5 points</u>	<u>51th place 4,2 points</u>	<u>81th place 1,2 points</u>
<u>23th place 11 points</u>	<u>52th place 4,1 points</u>	<u>82th place 1,1 points</u>
<u>24th place 10,5 points</u>	<u>53th place 4 points</u>	<u>83th place 1 points</u>
<u>25th place 10 points</u>	<u>54th place 3,9 points</u>	<u>84th place 0,9 points</u>
<u>26th place 9,5 points</u>	<u>55th place 3,8 points</u>	<u>85th place 0,8 points</u>
<u>27th place 9 points</u>	<u>56th place 3,7 points</u>	<u>86th place 0,7 points</u>
<u>28th place 8,5 points</u>	<u>57th place 3,6 points</u>	<u>87th place 0,6 points</u>
<u>29th place 8 points</u>	<u>58th place 3,5 points</u>	<u>88th place 0,5 points</u>
<u>30th place 7,5 points</u>	<u>59th place 3,4 points</u>	<u>89th place 0,4 points</u>
	<u>60th place 3,3 points</u>	<u>90th place 0,3 points</u>
		<u>91th place 0,2 points</u>
		<u>92th place 0,1 points</u>
		<u>93th place and after 0 points</u>

2. All other fencers in order of age, starting from the youngest.

~~3— The allocation of fencers in the pools must be made in such a way as to place fencers of the same nationality, as far as possible, in different pools, by moving them down the ranking as necessary.~~

~~4— If in any category there are fewer than ten competitors, the competition is held as a poule unique followed by direct elimination.~~

~~5— If in any category there are fewer than 6 competitors, they will fence with the next lower age category. A separate ranking for that category will be extrapolated from the combined categories' final rankings at the end of the competition.~~

~~6— If in any category there is only one competitor, the event in that category is cancelled.~~

~~7— No fencer is eliminated after the pools, all are entered into the direct elimination.~~

## **~~C. VETERANS~~**

### **~~Team championships~~**

#### **o.103**

~~1— Participation~~

~~Each country may enter one team per gender and per weapon, thus giving a total of 6 competitions.~~

~~The teams shall be composed of fencers who participated in the individual competition of the corresponding weapon, but c.f. o.103.2 b below.~~

~~2— The rules for team competitions are applicable with the following exceptions:~~

~~a) For each weapon, the teams are composed of three fencers of the same nationality, one from category "A", one from "B" and one from "C", with or without a reserve for each category. A team cannot begin the match if it is not complete.~~

~~b) In the case of a team being short of a fencer in any of the weapons, the team may use a fencer who has competed in the individual championships at another weapon or who is registered but has yet to compete, but his/her ranking will be deemed to be last in the individual competition at the weapon of the team in which he is going to fence plus 1.~~

~~c) The teams are placed in the pools according to the ranking of the three fencers in the individual championship, the team having the lowest total being ranked highest. All the fencers registered for the team event must be present at the piste before the start of the match.~~

~~d) Each team may request, before a given bout, the substitution of a fencer. However, in case of injury or other medical reason duly recognized by the Medical delegate, the substitution can be immediate, even during the relay.~~

~~There can only be one substitution per team per match.~~

~~3— A fencer who has been replaced because of an injury may not fence again during that match. If both a fencer and the reserve, if any, are forced to retire, or if a fencer is excluded, their team is deemed to have lost the match.~~

- ~~4— The relay system is always applied. The three fencers of a team fence against their opponent of the same category. Each fencer fences his/her opponent twice giving a total of 6 bouts. The bouts are for 5 hits (5-10-15-20 etc.). Exceptionally, a relay may end at more than 5,10,15 etc. if a fencer scores a valid last hit of the relay and is at the same time awarded an additional penalty hit: in this case both hits will be counted; the maximum time for each bout is 3 minutes.~~
- ~~5— The team that first reaches the maximum score of 30 hits, or that which has scored the greatest number of hits after the expiry of regulation time, is the winner.~~
- ~~6— The order of categories for each match is established by the referee with the captains on the piste prior to the start of the match: The referee will draw lots and the winning captain will choose the first category in the order. The losing captain will choose the second category.~~
- ~~7— The competition consists of a round of pools of 3 or 4 teams, in which all the teams participate, and a direct elimination phase for the highest placed 16 teams; the other teams will be classified according to their ranking after the round of pools.
  - ~~a) — The order of fights in a pool of 4 is as follows:
    - ~~b) — Match 1 : The team ranked 1 vs the team ranked 4~~
    - ~~— Match 2 : The team ranked 2 vs the team ranked 3~~
    - ~~Match 3 : The winner of Match 1 vs the loser of Match 2~~
    - ~~— Match 4 : The winner of Match 2 vs the loser of Match 1~~
    - ~~— Match 5 and Match 6 : The two remaining matches.~~~~
  - ~~b) — The order of fights in a pool of 3 is as follows:
    - ~~— Match 1 : The team ranked 2 vs the team ranked 3~~
    - ~~— Match 2 : The team ranked 1 vs the loser of Match 1~~
    - ~~— Match 3 : The team ranked 1 vs the winner of Match 1~~~~~~

~~The initial ranking on which the drawing of the pools is based is established from the results of the fencers in the individual events. (cf. o.103.2.c)~~

~~Using the results of the pools, an overall ranking is established, from which the top 16 (or 8 if there are fewer than 16 teams taking part) are promoted to a direct elimination tableau, in which the teams are placed according to this ranking. Should there be absolute equality in results between teams ranked 16 and 17 (or 8 and 9), the team ranked higher before the round of pools will be qualified.~~

~~However, teams which have already fenced each other in the pools should not meet again immediately in the direct elimination. To avoid this, the lower ranked of the two teams in question may be moved:~~

- ~~— in the case of a tableau of 16, the team ranked 9 may change places only with the team ranked 10, the team ranked 11 may change places only with the team ranked 12, the team ranked 13 may change places only with the team ranked 14 and the team ranked 15 may change places only with the team ranked 16.~~
- ~~— in the case of a tableau of 8, the team ranked 5 may change places only with the team ranked 6 and the team ranked 7 may change places only with the team ranked 8.~~



- ~~8— If there are fewer than 6 teams, they all fence in a poule unique; a match for the 3rd and 4th places is then held, followed by a match for the first place between the teams who came 1st and 2<sup>nd</sup> in the pool.~~
  - ~~9— The places in the final ranking table from 5th onwards are not fought for and teams are classified, within each round of the table, according to their ranking after the poules.~~
- 

## **o.103**

### ~~1— Participation~~

~~Each country may enter one team per category (Veterans and Grand Veterans) per gender and per weapon, thus giving a total of twelve competitions.~~

~~The teams shall be composed of fencers who participated in the individual competition of the corresponding weapon, but c.f. o.103.2 b below.~~

### ~~2— The rules for team competitions are applicable with the following exceptions:~~

~~**Veterans:** teams of three composed of fencers belonging to either age group 40-49 or to age group 50-59, with at least one fencer belonging to age group 50-59, plus up to two reserves.~~

~~**Grand Veterans:** teams of three composed of fencers belonging to either age group 60-69 or to age group 70 and over, with at least one fencer belonging to age group 70 and over, plus up to two reserves.~~

~~Fencing mode is 45 hits relay described in o.99 with application of passivity rule at any bout.~~

~~The competition begins with a round of pools of 3 and 4 teams established according to o.103 c) and followed by a direct elimination phase according to o.103 7.~~

~~Particular cases depending on the number of teams:~~

- ~~• only 1 team: the organisers must inform all nations that there will be no competition at that weapon.~~
- ~~• 2 teams: only one match between these two teams.~~
- ~~• 3 teams: one poule of three followed by D.E. from an incomplete tableau of 4.~~
- ~~• 4 teams: one poule of four followed by D.E. from a tableau of 4.~~
- ~~• 5 teams: one poule of five followed by D.E. from an incomplete tableau of 8.~~

~~The losers of the semi-finals have to fence for the Bronze medal.~~

~~a) — In the case of a team being short of a fencer in any of the weapons, the team may use a fencer who has competed in the individual championships at another weapon or who is registered but has yet to compete, but his/her ranking will be deemed to be last in the individual competition at the weapon of the team in which he is going to fence plus 1.~~

~~b) — The teams are placed in the pools according to the ranking of the three fencers in the individual championship, the team having the lowest total being ranked highest. All the~~

~~fencers registered for the team event must be present at the piste before the start of the match.~~

~~c) — Each team may request, before a given bout, the substitution of a fencer. However, in case of injury or other medical reason, duly recognized by the medical delegate, the substitution can be immediate, even during the relay.~~

~~There can be up to two substitutions of reserves per match but must maintain compliance with the age category representation requirement.~~

~~3 — A fencer who has been replaced because of an injury or other medical reason may not fence again during that match. If both a fencer and the reserve, if any, are forced to retire, or if a fencer is excluded, their team is deemed to have lost the match.~~

~~4 — The competition consists of a round of pools of 3 or 4 teams, in which all the teams participate, and a direct elimination phase for the highest placed 16 teams; the other teams will be classified according to their ranking after the round of pools.~~

~~a) — The order of fights in a pool of 4 is as follows:~~

~~Match 1 : The team ranked 1 vs the team ranked 4~~

~~Match 2 : The team ranked 2 vs the team ranked 3~~

~~Match 3 : The winner of Match 1 vs the loser of Match 2~~

~~Match 4 : The winner of Match 2 vs the loser of Match 1~~

~~Match 5 and Match 6 : The two remaining matches.~~

~~b) — The order of fights in a pool of 3 is as follows:~~

~~Match 1 : The team ranked 2 vs the team ranked 3~~

~~Match 2 : The team ranked 1 vs the loser of Match 1~~

~~Match 3 : The team ranked 1 vs the winner of Match 1~~

~~The initial ranking on which the drawing of the pools is based is established from the results of the fencers in the individual events. (cf. o.103.2.c)~~

~~Using the results of the pools, an overall ranking is established, from which the top 16 (or 8 if there are fewer than 16 teams taking part) are promoted to a direct elimination tableau, in which the teams are placed according to this ranking. Should there be absolute equality in results between teams ranked 16 and 17 (or 8 and 9), the team ranked higher before the round of pools will be qualified.~~

~~However, teams which have already fenced each other in the pools should not meet again immediately in the direct elimination. To avoid this, the lower ranked of the two teams in question may be moved:~~

~~— in the case of a tableau of 16, the team ranked 9 may change places only with the team ranked 10, the team ranked 11 may change places only with the team ranked 12, the team ranked 13 may change places only with the team ranked 14 and the team ranked 15 may change places only with the team ranked 16.~~

~~— in the case of a tableau of 8, the team ranked 5 may change places only with the team ranked 6 and the team ranked 7 may change places only with the team ranked 8.~~

~~5 — If there are fewer than 6 teams, they all fence in a poule unique; a match for the 3rd and 4th places is then held, followed by a match for the first place between the teams who came 1st and 2<sup>nd</sup> in the pool.~~

~~6 The places in the final ranking table from 5th onwards are not fought for and teams are classified, within each round of the table, according to their ranking after the poules.~~

~~Application : during the test at the 2025 World Championships (not applicable in 2023 and 2024).~~

---

## ~~D.C. OLYMPIC GAMES~~

### **o.104**

The organisation formulae for the Olympic Games are established by the Executive Committee, with the approval of the IOC. (See art. 9.1.1.1 of the Administrative rules).

---

## **PART C - VETERANS**

### **BODIES RESPONSIBLE FOR ORGANISATION AND CONTROL**

#### ***Organising Committee Veterans***

### **o.111**

The Directoire Technique is composed of people who have the experience and competence to organise competitions.

The Directoire Technique is composed of four members of different nationalities, one of whom must represent the country where the competition is held **and, if possible, a representative of the country where the competition will be held the following year.**

#### ***Appointment of refereeing, SEMI and medical delegates***

### **o.112**

Refereeing delegates must be members of the FIE Refereeing Commission.  
SEMI delegates must be members of the FIE SEMI Commission.  
Medical delegates must be members of the FIE Medical Commission.

#### **Veterans World Championships**

Two Refereeing delegates, one SEMI delegate and two Medical delegates are appointed by the FIE Executive Committee following the recommendations of the respective commissions.

#### ***Refereeing***

### **o.113**

Refereeing at Veteran World Championships is carried out by referees appointed by the Executive Committee of the FIE, selected by the Refereeing Commission on indication of the Organizing Committee and Veterans Council.

Referees must attend the refereeing meeting that takes place the day before the World Championships.

## **AGE OF PARTICIPANTS**

### **o.114**

The age groups in veteran competitions are:

- a) Age group 50-59: Must be at least 50 years old and less than 60 years old in the year of the competition.
- b) Age group 60-69: Must be at least 60 years old and less than 70 years old in the year of the competition.
- c) Age group 70+: Must be at least 70 years old in the year of the competition.

---

The age groups in veteran competitions are:

- a) Age group 40-49: Must be at least 40 years old and less than 50 years old in the year of the competition.
- b) Age group 50-59: Must be at least 50 years old and less than 60 years old in the year of the competition.
- c) Age group 60-69: Must be at least 60 years old and less than 70 years old in the year of the competition.
- d) Age group 70+: Must be at least 70 years old in the year of the competition.

**Application : during the test at the 2025 World Championships (not applicable in 2023 and 2024)**

---

## ***Pre-competition procedures***

### **PROGRAMMING**

#### **VETERANS WORLD CHAMPIONSHIPS**

##### **o.115**

- 1 The programme of the Veteran World Fencing Championships comprises twenty-four events, eighteen individual – three categories for each weapon - and six team — male foil, female foil, male epee, female epee, male sabre and female sabre. The programme must be arranged in such a way as to allow any fencer to participate in all weapons. Team events must be held on the day following the last championship of the three categories of each weapon.
- 2 No changes of dates are allowed for any competition, after the release of the programme.
- 3 Each competition must be held in one single day, avoiding long periods of inactivity.

- 
- 1 The programme of the Veteran World Fencing Championships comprises thirty-six events, twenty-four individual – four categories for each weapon - and twelve team — male foil, female foil, male epee, female epee, male sabre and female sabre (two categories for each weapon and gender). The programme must be arranged in such a way as to allow any fencer to

participate in all weapons. Team events must be held on the day following the last championship of the corresponding two individual categories of each weapon.

- 2 No changes of dates are allowed for any competition, after the release of the programme.
- 3 Each competition must be held in one single day, except for team events for which the round of pools may be achieved the day before direct elimination avoiding long periods of inactivity.

**Application: during the test at the 2025 World Championships (not applicable in 2023 and 2024)**

## **INVITATIONS**

### **Invitation to international officials**

#### **Veterans**

##### **o.116**

- 1 Any proposed candidature for organising the Veteran World Championships must be studied at the venue concerned by an ad hoc delegation designated by the Executive Committee, at the invitation of the candidate federation.
- 2 The organising committee, who will receive all the entry fees from the participating delegations, must, at their own expense, invite the following international officials (tourist-class return air fare, accommodation and daily allowances):
  - a) The President of the FIE or his representative, who presides over the World Championships and, in particular, controls the smooth running of the Directoire Technique.
  - b) Four members of the Directoire Technique appointed by the Executive Committee of the FIE, one of whom must belong to the organising country.
  - c) One member of the SEMI-~~Committee~~ Commission, appointed by the Executive Committee of the FIE.
  - d) ~~One~~ **Two** members of the Refereeing ~~Committee~~ Commission, appointed by the Executive Committee of the FIE.
  - e) Two members of the Medical ~~Committee~~ Commission, appointed by the Executive Committee of the FIE.
  - f) The referees appointed by the Executive Committee of the FIE.

The officials a) to e) should preferably be selected from the Zone in which the Championships are being held.

## **ENTRIES**

### **Veterans World Championships**

#### **Entries for competitions**

##### **o.117**

- 1 The **entry of the names** of the fencers and all possible replacements, and the entry of teams, must be made via the FIE website 7 days before the competition at the latest (midnight Lausanne time).  
For team entries, the names of the fencers making up the teams may be changed, by informing the organizers, up to the day before the competition, not later than 4.00 pm (local time).  
However, a replacement can be made after this stage, and at the latest at the end of the individual event, in the case of injury or other medical reason duly certified by the competition

medical doctor.

## **2 Withdrawal of a fencer or team.**

After the closing deadline for entries, no named fencer or team may be withdrawn except for injury or other medical reason or force majeure: the national federation must inform the FIE and the organizers.

## **3 Substitution of a fencer.**

Until the Wednesday preceding the competition (midnight, Lausanne time), a fencer may be replaced by another. To do this, the national federation must send to the FIE, by fax or e-mail, a written request to substitute the fencer.

## **4 Addition of a fencer or a team after the dead-line.**

From the Wednesday preceding the competition until 12 noon (local time) on the day preceding the competition, one or more fencers and/or a team may be added by national federations after payment to the FIE of a penalty according to the scale in force (cf o.31, table of financial penalties and fines).

**5** Should a fencer or team who have been entered not present themselves to fence, a fine (cf o.31, table of financial penalties and fines), payable to the FIE, will be imposed to the federation of the faulty fencer or team, except in cases of properly authenticated 'force majeure'.

**6** The organisers of all official competitions must, at risk of a penalty of a fine payable to the FIE (cf o.31, table of financial penalties and fines), refuse any entry of either fencer or referee not in possession of an FIE license valid for the current season.

## ***PROCEDURES DURING COMPETITIONS***

### ***Composition of the pools for the individual Veterans championships***

#### **o.118**

The pools are composed taking into account the following orders of strength:

- 1 The fencers ranked from the addition of the results in the previous two **years** Veterans World Championships, irrespective of age category changes.

Scores are awarded according to the following table:

1st place 80 points	31th place 7 points	61th place 3,2 points
2nd place 65 points	32th place 6,5 points	62th place 3,1 points
3rd place <i>ex aequo</i> 50 points	33th place 6 points	63th place 3 points
5th place 38 points	34th place 5,9 points	64th place 2,9 points
6th place 36 points	35th place 5,8 points	65th place 2,8 points
7th place 34 points	36th place 5,7 points	66th place 2,7 points

8th place 32 points	37th place 5,6 points	67th place 2,6 points
9th place 30 points	38th place 5,5 points	68th place 2,5 points
10th place 28 points	39th place 5,4 points	69th place 2,4 points
11th place 26 points	40th place 5,3 points	70th place 2,3 points
12th place 24 points	41th place 5,2 points	71th place 2,2 points
13th place 22 points	42th place 5,1 points	72th place 2,1 points
14th place 20 points	43th place 5 points	73th place 2 points
15th place 18 points	44th place 4,9 points	74th place 1,9 points
16th place 16 points	45th place 4,8 points	75th place 1,8 points
17th place 14 points	46th place 4,7 points	76th place 1,7 points
18th place 13,5 points	47th place 4,6 points	77th place 1,6 points
19th place 13 points	48th place 4,5 points	78th place 1,5 points
20th place 12,5 points	49th place 4,4 points	79th place 1,4 points
21th place 12 points	50th place 4,3 points	80th place 1,3 points
22th place 11,5 points	51th place 4,2 points	81th place 1,2 points
23th place 11 points	52th place 4,1 points	82th place 1,1 points
24th place 10,5 points	53th place 4 points	83th place 1 points
25th place 10 points	54th place 3,9 points	84th place 0,9 points
26th place 9,5 points	55th place 3,8 points	85th place 0,8 points
27th place 9 points	56th place 3,7 points	86th place 0,7 points
28th place 8,5 points	57th place 3,6 points	87th place 0,6 points
29th place 8 points	58th place 3,5 points	88th place 0,5 points
30th place 7,5 points	59th place 3,4 points	89th place 0,4 points
	60th place 3,3 points	90th place 0,3 points
		91th place 0,2 points
		92th place 0,1 points
		93th place and after 0 points

- 2** All other fencers in order of age, starting from the youngest.
- 3** The allocation of fencers in the pools must be made in such a way as to place fencers of the same nationality in different pools, as far as possible (staggering).
- 4** If in any category there are fewer than ten competitors, the competition is held as a poule unique followed by direct elimination.
- 5** If in any category there are fewer than 6 competitors, they will fence with the next lower age category. A separate ranking for that category will be extrapolated from the combined categories' final rankings at the end of the competition.
- 6** If in any category there is only one competitor, the event in that category is cancelled.
- 7** No fencer is eliminated after the pools. All the fencers participate in the direct elimination phase.

## **VETERANS TEAM EVENTS**

### **o.119**

#### **1 Participation**

Each country may enter one team per gender and per weapon, thus giving a total of 6 competitions.

The teams shall be composed of fencers who participated in the individual competition of the corresponding weapon, but c.f. o.103.2 b below.

- 2** The rules for team competitions are applicable with the following exceptions:
  - a)** For each weapon, the teams are composed of three fencers of the same nationality, one from category "A", one from "B" and one from "C", with or without a reserve for each category. A team cannot begin the match if it is not complete.
  - b)** In the case of a team being short of a fencer in any of the weapons, the team may use a fencer who has competed in the individual championships at another weapon or who is registered but has yet to compete, but his/her ranking will be deemed to be last in the individual competition at the weapon of the team in which he is going to fence plus 1.
  - c)** The teams are placed in the pools according to the ranking of the three fencers in the individual championship. The team ranked 1 is the one having the lowest total. All the fencers registered for the team event must be present at the piste before the start of each match.
  - d)** Each team may request, before a given relay, the substitution of a fencer. However, in case of injury or other medical reason duly recognized by the Medical delegate, the substitution can be immediate, even during the relay.

There can only be one substitution per team per match.

- 3** A fencer who has been replaced because of an injury may not fence again during that match. If both a fencer and the reserve are forced to retire, or if a fencer is excluded, their team is deemed to have lost the match.
- 4** The relay system is always applied. The three fencers of a team fence against their opponent of the same category. Each fencer fences his/her opponent twice giving a total of 6 relays. The relays are for 5 hits (5-10-15-20- etc.). Exceptionally, a relay may end at more than 5,10,15 etc. if a fencer scores a valid last hit of the relay and is at the same time awarded an additional penalty hit: in this case both hits will be counted; the maximum time for each relays is 3 minutes.
- 5** The team that first reaches the maximum score of 30 hits, or that which has scored the greatest number of hits after the expiry of regulation time, is the winner.
- 6** The order of categories for each match is established by the referee with the captains on the piste prior to the start of the match: The referee will draw lots and the winning captain will choose the first category in the order. The losing captain will choose the second category.
- 7** The competition consists of a round of pools of 3 or 4 teams, in which all the teams participate, and a direct elimination phase for the highest placed 16 teams; the other teams will be classified according to their ranking after the round of pools.



- a)** The order of matches in a pool of 4 is as follows:  
Match 1 : The team ranked 1 vs the team ranked 4  
Match 2 : The team ranked 2 vs the team ranked 3  
Match 3 : The winner of Match 1 vs the loser of Match 2  
Match 4 : The winner of Match 2 vs the loser of Match 1  
Match 5 and Match 6 : The two remaining matches.
- b)** The order of matches in a pool of 3 is as follows:  
Match 1 : The team ranked 2 vs the team ranked 3  
Match 2 : The team ranked 1 vs the loser of Match 1  
Match 3 : The team ranked 1 vs the winner of Match 1

The initial ranking on which the drawing of the pools is based is established from the results of the fencers in the individual events. (cf. o.103.2.c)

The composition of the direct elimination table of 16 teams (or 8 if there are less than 16 teams) is established according to the general ranking established by the results of all the teams in the pool round. In the event of an absolute tie between the teams ranked 16 and 17 (or 8 and 9), the highest ranked team in the initial pool ranking shall qualify.

However, in no case, teams which have already fenced each other in the pools should meet again immediately in the direct elimination. To avoid this, the lower ranked of the two teams in question may be moved:

- in the case of a tableau of 16, the team ranked 9 may change places only with the team ranked 10, the team ranked 11 may change places only with the team ranked 12, the team ranked 13 may change places only with the team ranked 14 and the team ranked 15 may change places only with the team ranked 16.
  - in the case of a tableau of 8, the team ranked 5 may change places only with the team ranked 6 and the team ranked 7 may change places only with the team ranked 8.
- 8** If fewer than 6 teams participate in the competition, they all fence in a poule unique; a match for the 3rd and 4th places is then held, followed by a match for the first place between the teams who came 1st and 2nd in the pool.
- 9** Ranking matches from 5th place onwards will not be fenced and teams will be ranked, in each round of the table, according to their ranking after the pools.

---

## 1 Participation

Each country may enter one team per category (Veterans and Grand Veterans) per gender and per weapon, thus giving a total of twelve competitions.

The teams shall be composed of fencers who participated in the individual competition of the corresponding weapon, but c.f. o.103.2 b below.

## 2 The rules for team competitions are applicable with the following exceptions:

Veterans: teams of three composed of fencers belonging to either age group 40-49 or to age group 50-59, with at least one fencer belonging to age group 50-59, plus up to two reserves.

Grand Veterans: teams of three composed of fencers belonging to either age group 60-69 or to age group 70 and over, with at least one fencer belonging to age group 70 and over, plus up to two reserves.

Fencing mode is 45 hits relay described in o.99 with application of non-combativity rule at any match.

The competition begins with a round of pools of 3 and 4 teams -established according to o.103 c) - and followed by a direct elimination phase according to o.103 7.

Particular cases depending on the number of teams:

- only 1 team: the organisers must inform all nations that there will be no competition at that weapon.
- 2 teams: only one match between these two teams.
- 3 teams: one poule of three followed by D.E. from an incomplete tableau of 4.
- 4 teams: one poule of four followed by D.E. from a tableau of 4.
- 5 teams: one poule of five followed by D.E. from an incomplete tableau of 8.

The losers of the semi-finals have to fence for the Bronze medal.

- a) In the case of a team being short of a fencer in any of the weapons, the team may use a fencer who has competed in the individual championships at another weapon or who is registered but has yet to compete, but his/her ranking will be deemed to be last in the individual competition at the weapon of the team in which he is going to fence plus 1.
- b) The teams are placed in the pools according to the ranking of the three fencers in the individual championship. The number 1 team is the one with the least points. All the fencers registered for the team event must be present at the piste before the start of each match.
- c) Each team may request, before a given relay, the substitution of a fencer. However, in case of injury or other medical reason, duly recognized by the medical delegate, the substitution can be immediate, even during the relay.

There can be up to two substitutions of reserves per match but must maintain compliance with the age category representation requirement.

**Application :** during the test at the 2025 World Championships (not applicable in 2023 and 2024).

**Opinion of the SEMI Commission: IN FAVOUR**

**In view of the increase in size of the Veteran World Championships it is essential that a minimum of 2 SEMI Delegate should be appointed for efficient running of the competition**

---

**Article:** o.105

P.13

**Proposal from:** Rules Commission

**Motivation:** the zone championships benefit from a coefficient of 1.5. ~~4~~ **8** pistes must be equipped with video refereeing.

**Video-refereeing**

**o.105**

4. For individual competitions of the Junior and Cadet World Championships, video-refereeing is compulsory as soon as the timetable allows the competition to be run on a **maximum of 8** pistes, all equipped for video-refereeing and in any case, from the table of 32.

For team competitions ~~in the conventional weapons~~, video-refereeing is compulsory **from the table of 16**, including ranking matches table 5-8.

~~In epee, video-refereeing is compulsory from the table of 8, including ranking matches table 5-8.~~

Senior zonal championships	T 64	T 16	<del>4</del> or 8	T 1-8
----------------------------	------	------	-------------------	-------

**Opinion of the SEMI Commission: IN FAVOUR**

**With amendments** ~~deleted 4 or~~ **maximum of**

---



Proposals for the 2023 Congress  
Modifications of the Technical Rules

The texts below are applicable on January 1st, 2024, unless mentioned otherwise.

P. 19

Article: **t.18**

Proposal from: Rules Commission

**Motivation:** In the last 2m of the piste, draw a line down the middle (1m). This allows the Referee to define more precisely the lateral exit of the foot(s) to judge whether or not the rear limit has been left.

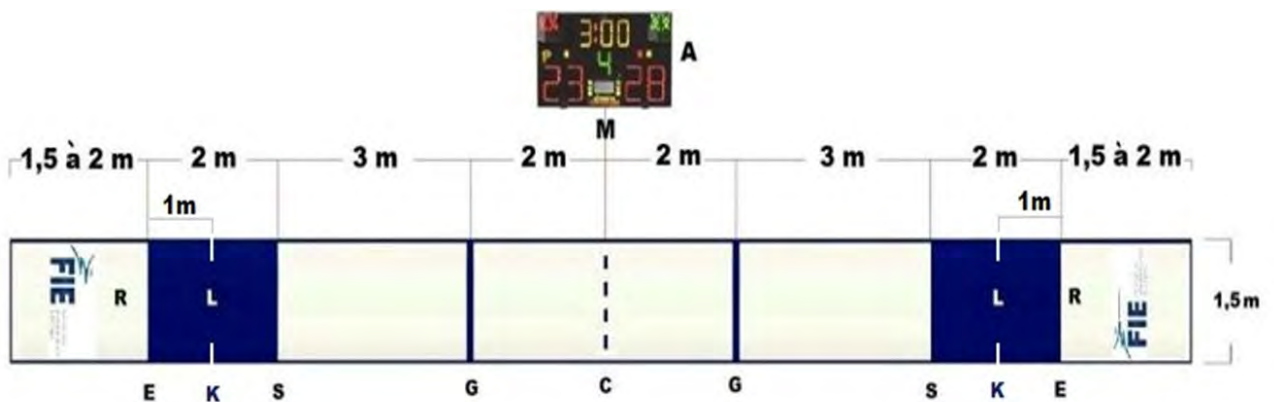
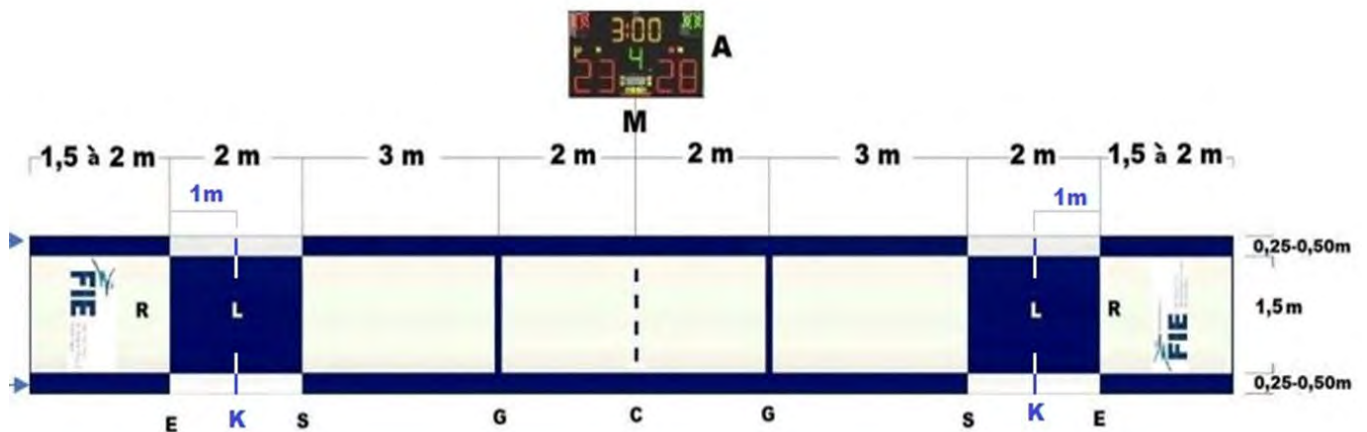

**Opinion of the SEMI Commission: NOT IN FAVOUR Unless the Referees Commission can justify the benefits versus the high cost and technical difficulties of altering existing pistes with conductive replacement sections**

---

P.20

**Article: t.18.2**

**Proposal from: SEMI Commission**

**Motivation:** Based on the experience on the field of play, the metal frames, when hooking one element to another, leave a gap of 2/3 mm, this means that a tolerance of 4 cm must be foreseen in the total length; the same tolerance has to be considered for the carpet piste because off the material is more stretching, so when the piste is fully extended, there may be a stretch of the material similar to the metal piste.

**t.18.2**

The piste is 14 metres long, with a total tolerance on the whole length of 4 cm, so that each competitor, being placed at 2 metres from the centre line, has at his disposal for retreating a total distance of 5 metres without it being necessary for him to cross the rear limit of the piste with both feet.

**Opinion of the SEMI Commission: IN FAVOUR**

---

P.28

**Article: t.64 and t.170.4.1**

**Proposal from: Fencing Federation of Jamaica**

**Motivation:** The motivation for this proposal is to enable fencers and federations who are unable to provide a coach at a competition to have access to a coach via virtual means in the future. This would help to level the playing field by removing financial and resource constraints that can limit a fencer's opportunities. By providing virtual coaching, fencers would have access to guidance and support that they might not otherwise have, which would help them to perform at their best and reach their full potential. Ultimately, this proposal aims to promote greater inclusivity and equity in fencing, allowing more athletes to participate and compete on a fair and equal footing.

Insert item #7

**Regulation equipment and checking of equipment by the referee**

**t.64**

7. the virtual coaching mechanism is activated, and in the unobstructed designated area for coaches.

#### **t.170.4.1**

"Fencer equipped with electronic communication equipment permitting ~~him~~ to receive communications during bout"

Fencer equipped with electronic communication equipment permitting ~~them~~ to receive communications during bout, [unless previously authorized virtual coach device to communicate with fencer during authorized moments, in coaching area.](#)

**Opinion of the SEMI Commission: NOT IN FAVOUR require further verification of systems to be used.**

---

P. 29

**Article:** **t.70**

**Proposal from:** Rules Commission

**Motivation:** Add m.11 Fixation of the tip to t.70 material not in conformity.

#### ***Non-standard equipment***

##### **t.70**

In whatever circumstances a fencer on the piste is found to be in possession of equipment which is **non-regulation or defective (cf.m.8, m.9, m.11, m.12, m.13, m.16, m.17, m.23)**, the referee confiscates the equipment and submits it to the experts on duty for examination. The equipment in question will only be returned to the owner after the measures necessitated by this examination have been completed and, if appropriate, after the payment of any expenses for repairs. The equipment must be rechecked before it is used again.

**Opinion of the SEMI Commission: IN FAVOUR**

---

P.30

**Article:** **t.77, t.91 and t.98**

**Proposal from:** Rules Commission

**Motivation:** Update of the drawings concerning the valid target at the three weapons.

##### **t.77**

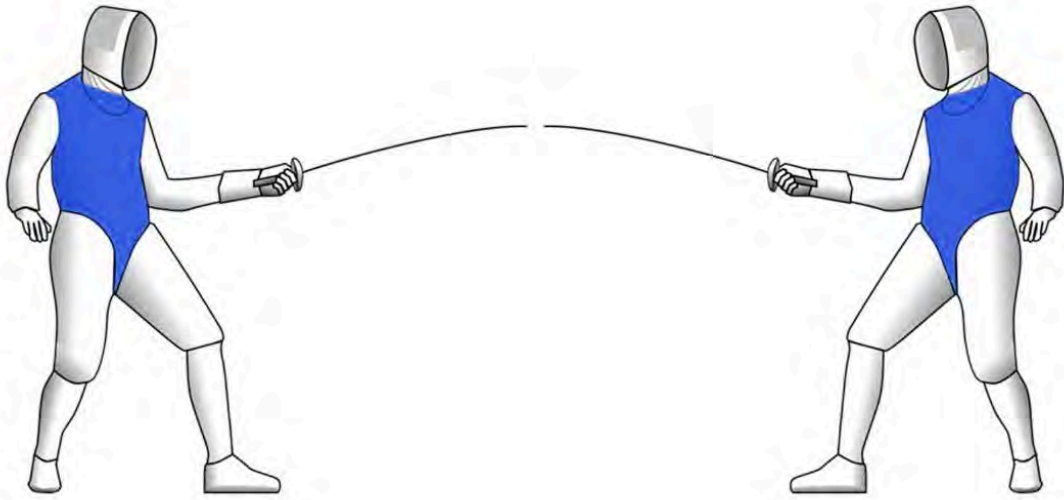

Figure 4 Valid target at foil

**t.91**

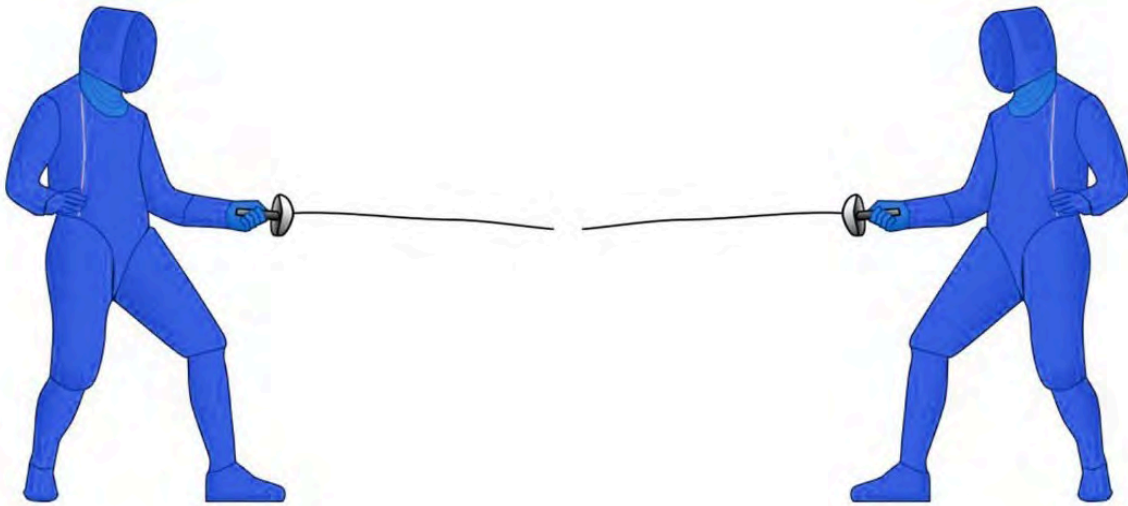

Figure 5 Valid target at épée

**t.98**

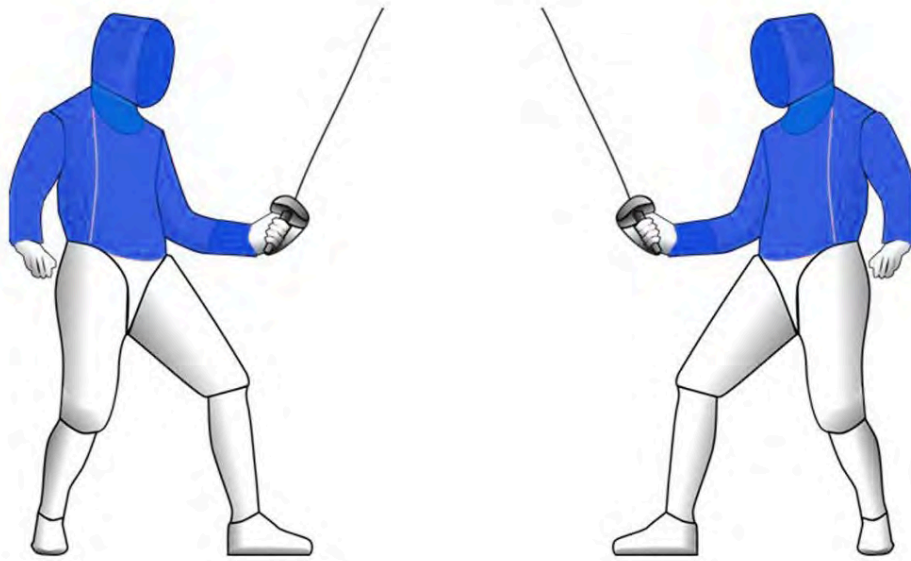

Figure 6 Valid target at sabre

Opinion of the SEMI Commission: **IN FAVOUR** Request additional drawings showing

1 Rear of targets for Foil and Sabre showing the hips

2 Details of the sabre glove

3 Bib on foil mask

P.33

**Article: t.109**

**Proposal from: Women and Fencing Council**

**Motivation:**

- 1) To clarify the expectation on all participants in a competition to respect the FIE statutes and rules, including the Ethical Code and Safeguarding Policy.
- 2) To clarify the minimum reporting expectations if people witness a breach of the Ethical Code and Safeguarding Policy.

**t.109**

Everybody taking part in or present at a fencing competition **must respect the FIE statutes and rules, including but not limited to the FIE Ethical Code and Safeguarding Policy. They must remain orderly and must not disturb the smooth running of the competition.** During bouts no one is allowed to **go near the pistes, to give advice to the fencers, to criticise the Referee or the**



judges, to insult them or to attempt to influence them in any way. Even the **team captain** must remain in the space assigned to him and he may only intervene in the situations and in the manner provided for in Article t.130 of the Rules. The Referee must stop immediately any activity which disturbs the smooth running of the bout which he is refereeing (cf. t.137.1–3). Any person who, for any reason, threatens or insults an official commits an offence of the 4th group and is penalised according to article t.169.

Any person present who witnesses a breach of the FIE Ethical Code and the Safeguarding Policy must report this to the [Safeguarding Officer if present, or to the Directoire Technique](#).

**Opinion of the SEMI Commission: IN FAVOUR with amendment**

---

**Article:** [t.111](#)

P.34

**Proposal from:** Women and Fencing Council

**Motivation:** To clarify that disturbing good order or smooth running can include failures to act in accordance with the FIE statutes, rules, Ethical Code and Safeguarding Policy.

**t.111**

The Referee and/or the Directoire Technique, on their own authority or at the request of an official delegate of the FIE or of the Organising Committee, can decide to expel from the competition venue, with or without a warning, any person who by his gestures, attitude, ~~or~~ language or failure to act in accordance with the FIE statutes, rules, Ethical Code and Safeguarding Policy, disturbs the good order or smooth running of the event.

**Opinion of the SEMI Commission: IN FAVOUR**

---



**Proposals for the 2023 Congress  
Modifications of the Material Rules**

The texts below are applicable on January 1st, 2024, unless mentioned otherwise.

---

P.45

**Article:** m.25.3.h

**Proposal from:** SEMI Commission

**Motivation:** The growing number of past World Champions (36 per year) means that in about ten years we will end up with at least 250 red writings on the field.

In this way there is no longer any added value for the different colour.

On the other hand, it is acceptable that there are no time limits for the writing of the Olympic Champions.

**m.25.3.h**

A World Champion has the right to have his/her name and the abbreviation of his/her national federation printed in red for the following season.

An Olympic Champion has the right to have his/her name and the abbreviation of his/her national federation printed in gold.

**Opinion of the SEMI Commission:** IN FAVOUR as amended. It is difficult in weapon control to verify who is entitled

---

P.46

**Article:** m.30.1

**Proposal from:** Refereeing Commission

**Motivation:** To make clear that foil and sabre masks cannot be used in epee events

**RULES SPECIFIC TO EPEE**

**Mask**

**m.30. 1.** The mask must not be covered, in whole or in part, by **conductive material or** material which can **cause the point to glance off** (cf. m.25).

2. The mask must be so shaped that the **bib** reaches below the prominences of the collar bones (clavicles).

**Opinion of the Semi Commission: IN FAVOUR**

P. 47

**Article:** Annex A 4 Label of quality, Material Rules (see Urgent letter 2/2022)

**Proposal from:** SEMI Commission - deferred proposal from the 2022 Congress

**Motivation:** The installation of this RFID into the fencing clothing (mask, under plastron, jacket and breeches) is suspended until further notice.

Therefore, the manufacturers will be allowed to use ~~for 2022 (is yearly dated)~~ the old technical FIE mark (round). It will also be necessary to postpone the final date at which all the equipment must have the RFID and the new quality seal, ~~from the season 2026/2027 to the season 2027/2028.~~

Due to the current situation, the orders to the company and deliveries of RFID are currently suspended. In the meantime, we are trying to find other companies that can produce and deliver these chips.

2. Chip and label installation requirements are suspended

Page 80

~~From 01.03.2021, the obligatory chipping of new fencing equipment (jacket, trousers, plastron mask) has been introduced. It will be mandatory from 01.01.2023.~~

~~Both variants of the FIE seal of quality are acceptable up to and including the 2026/2027 2025/2026 season.~~

~~For the 2027/2028 2026/2027 season, masks, jackets, breeches and plastrons must have the new quality seal with a chip securely located underneath.~~

~~Cancellation of the text while waiting for a new system.~~

**Opinion of the SEMI Commission: IN FAVOUR as amended also delete drawings**

P.48

**Article:** Annex A, 4.4

**Proposal from:** SEMI Commission

**Motivation:** The sentence is remaining into the rule after the introduction of the tests for the sabre maraging blades, but is no more actually and the test to carry on at today is the K1C.

**Annex A, 4.4**

4.4. Test of strength at the fracture toughness point, K1C

The ~~K<sub>IC</sub>~~ **K<sub>1C</sub>** value of the steel must be measured by traction on a CT sample which has the dimensions indicated at the end of this annexe (Table VIII), made from materials subjected to the same thermal treatment as required for the blades, notched mechanically initiating a fatigue crack at the apex of the notch. The test must be conducted according to the methods indicated by the standard ASTM E 399. The value must conform to that laid down in Table I.

~~In cases where it is not possible to obtain a CT sample, the factor of increasing levels of dynamic loading (K<sub>Id</sub>) may be determined instead of the K<sub>IC</sub> value.~~

**Opinion of the SEMI Commission: IN FAVOUR**

---



## Proposals for the 2023 Congress

### Modifications of the Statutes

The texts below are applicable on January 1st, 2024, unless mentioned otherwise.

---

**Article: 4.4.2**  
**Proposal from: Legal Commission**

P.8

**Motivation:** Refine the conditions for candidature for election to the SEMI Commission

4.4.2 To be candidate for a permanent commission or the Ethics Committee a person must hold a licence from his National Federation except if he is a Member of Honour, be at least 21 years of age on the date of the elections and enjoy the full civic rights of the country to which he belongs.

~~It is desirable that the candidates for various Commissions have specific professional knowledge or credentials as follows:~~

A candidate for the - SEMI Commission must have a college degree in engineering or ~~science or~~ a subject relating to the work of the SEMI, be practising as an engineer or have been a member of the Commission for at least 8 years, or hold a qualification recognised by the SEMI Commission in Armoury work.

**Opinion of the SEMI Commission: IN FAVOUR with the above amendments**

The SEMI Commission will set selection criteria and development opportunities.



Proposals for the 2023 Congress  
Modifications of the Technical Rules

The texts below are applicable on January 1st, 2024, unless mentioned otherwise.

---

P.28

**Article:** t.64 and t.170.4.1

**Proposal from:** Fencing Federation of Jamaica

**Motivation:** The motivation for this proposal is to enable fencers and federations who are unable to provide a coach at a competition to have access to a coach via virtual means in the future. This would help to level the playing field by removing financial and resource constraints that can limit a fencer's opportunities. By providing virtual coaching, fencers would have access to guidance and support that they might not otherwise have, which would help them to perform at their best and reach their full potential. Ultimately, this proposal aims to promote greater inclusivity and equity in fencing, allowing more athletes to participate and compete on a fair and equal footing.

Insert item #7

**Regulation equipment and checking of equipment by the referee**

**t.64**

7. the virtual coaching mechanism is activated, and in the unobstructed designated area for coaches.

**t.170.4.1**

"Fencer equipped with electronic communication equipment permitting ~~him~~ to receive communications during bout"

Fencer equipped with electronic communication equipment permitting ~~them~~ to receive communications during bout, ~~unless previously authorized virtual coach device to communicate with fencer during authorized moments, in coaching area.~~

**Opinion of the Coaches Council:**

**Not in favor.**

T 64. The referee should check the fencers' equipment before the bout. No electronic communication equipment is allowed for communication during the bout.

But nothing stops the fencer, coach, administrator, or anybody else from using any communication equipment between the bouts or during the one-minute break in Direct Elimination when the fencer can have advice from the coach.

If it is unclear to the referees, we should ask the rules commission to make the necessary adjustments.

P.31

**Article:** t.84

**Proposal from:** Refereeing Commission

**Motivation:** in foil, it should be no difference between movement forward with step or step with legs crossing one another and follow by lunge and counted as an attack if it is correct executed when the straightening of the arm precedes the end of the step forward (without or with the legs crossing one another).\*

However continuous steps forward constitute a preparation.

**t.84**

3 Continuous steps forward, ~~with the legs crossing one another,~~ constitute a preparation and on this preparation any simple attack has priority.

\*This modification concerns English only.

**Opinion of the Coaches Council:**

**In favor**

---

**Article:** t.109

**Proposal from:** Women and Fencing Council

**Motivation:**

- 1) To clarify the expectation on all participants in a competition to respect the FIE statutes and rules, including the Ethical Code and Safeguarding Policy.
- 2) To clarify the minimum reporting expectations if people witness a breach of the Ethical Code and Safeguarding Policy.

**t.109**

Everybody taking part in or present at a fencing competition **must respect the FIE statutes and rules, including but not limited to the FIE Ethical Code and Safeguarding Policy. They must remain orderly and must not disturb the smooth running of the competition.** During bouts no one is allowed to **go near the pistes, to give advice to the fencers, to criticise the Referee** or the judges, to insult them or to attempt to influence them in any way. Even the **team captain** must remain in the space assigned to him and he may only intervene in the situations and in the manner provided for in Article t.130 of the Rules. The Referee must stop immediately any activity which disturbs the smooth running of the bout which he is refereeing (cf. t.137.1–3). Any person who, for any reason, threatens or insults an official commits an offence of the 4th group and is penalised according to article t.169.

Any person present who witnesses a breach of the FIE Ethical Code and the Safeguarding Policy must report this to the Directoire Technique.

**Opinion of the Coaches Council:**

**Not in favor.**

**Only referee can determine the rules braking or any other infringements in the designated area of the bout and “ Referee must stop immediately any activity which disturbs the smooth running of the bout which he is refereeing”**



Any other person present at the competitions who has problem with another person can follow the normal legal procedures.

P.34

**Article:** t.111

**Proposal from:** Women and Fencing Council

**Motivation:** To clarify that disturbing good order or smooth running can include failures to act in accordance with the FIE statutes, rules, Ethical Code and Safeguarding Policy.

**t.111**

The Referee and/or the Directoire Technique, on their own authority or at the request of an official delegate of the FIE or of the Organising Committee, can decide to expel from the competition venue, with or without a warning, any person who by his gestures, attitude, ~~or~~ language or failure to act in accordance with the FIE statutes, rules, Ethical Code and Safeguarding Policy, disturbs the good order or smooth running of the event.

**Opinion of the Coaches Council:**

**Not in favor.**

**Only referee can determine the rules braking or any other infringements in the designated area of the bout and “ Referee must stop immediately any activity which disturbs the smooth running of the bout which he is refereeing”**

**Any other person present at the competitions who has problem with another person can follow the normal legal procedures.**

P.35

**Article:** t.124 and o.68

**Proposal from:** Rules Commission

**Motivation:** To have an initial ranking in competitions to separate unranked fencers.

**t.124**

**Unwillingness to fight (Non-combativity)**

**1 Individual events – Direct elimination**

c) When, for the third time, there is one minute of unwillingness to fight, a P-black card is awarded as follows:

i) If the scores of the two fencers are equal, the Referee sanctions the fencer with the lower initial seeding in the competition, which is based on the FIE ranking **and by drawing lots among any fencers who are not in the ranking**, with a P-Black card. The fencer with the higher initial seeding in the competition, which is based on the FIE ranking, wins the bout.

**Composition of pools**

**o.68**

1 The pools are composed taking account of **the initial seeding in the competition, which is based on** the latest official FIE ranking and by drawing lots among any fencers who are not in the ranking. The pools are composed using the following method:

**Opinion of the Coaches Council:**

**In favor**

---

**RAPPORT DU CONSEIL DES ENTRAÎNEURS DE LA FIE**  
**FIE COACHES COUNCIL REPORT**  
**INFORME DEL CONSEJO DE LOS ENTRENADORES DE LA FIE**

<p><b>Date, lieu et heure de la réunion :</b> <b>Date, place and time of the meeting:</b> <b>Fecha, lugar y horario de la reunión:</b></p>	<p><b>FIE Coaching Council meeting</b></p> <ul style="list-style-type: none"> <li>• <b>DATE: 7<sup>th</sup> JULY – 8th JULY 2023</b></li> <li>• <b>ONLINE MEETING</b></li> <li>• <b>TIME: 13H00 LAUSANNE TIME</b></li> </ul>
<p><b>Participants:</b> <b>Participants:</b> <b>Participantes:</b></p>	<p><b>Present:</b></p> <ol style="list-style-type: none"> <li>1. <b>HAIBIN WANG - Executive Committee Member, Executive Committee Representative/ Coaches</b></li> <li>2. <b>TYSHLER GENNADY - RSA</b></li> <li>3. <b>LEI SHENG - CHI</b></li> <li>4. <b>NATALIA CONRAD – UKR</b></li> <li>5. <b>AOKI YUSUKI - JPN</b></li> </ol>
<p><b>Absences (indiquer si l'absence avait été annoncée) :</b> <b>Absent (indicate if the absence had been announced):</b> <b>Ausencias (indicar si la ausencia fue anunciada):</b></p>	<ol style="list-style-type: none"> <li>1. <b>GUICHOT PIERRE - FRA</b></li> <li>2. <b>SAUCEDO GUILLERMO - ARG</b></li> <li>3. <b>DMITRII GLOTOV - RUS</b></li> <li>4. <b>LEE HYUN-SOO – KOR</b></li> <li>5. <b>MASSIALAS GREGORY - USA</b></li> <li>6. <b>SOMLAI BELA - HUN</b></li> </ol>

**INTRODUCTION**  
**INTRODUCTION**  
**INTRODUCCIÓN**

The member of FIE COMEX, Mr. HAIBIN WANG, welcomes everybody to the FIE Coaches Council meeting. The agenda for the meeting was circulated. Thank you to all members present for making it possible to meet during the preparation period for the World Championship 2023.

**RAPPORT DE LA RÉUNION**  
**MEETING REPORT**  
**INFORME DE LA REUNIÓN**

**Point 1 / Item1 / Punto 1:**

G. Tyshler gave a short report on the year of work of the coaching council. Mr. Guillermo Sausedo sent his apologies that he is not able to attend the meeting today because of family issues. We do not have many points to discuss in our session today. We have sent the request to FIE for a joint meeting with the Athletes and Refereeing commissions. The refereeing commission did not respond to our request. As we do not have many points to discuss, finishing the meeting in one day instead of two days was proposed. The minutes of the previous council meeting were circulated and approved via email.

The Coaching Council President reports on the Council's work in 2022 – 2023.

Unfortunately, many projects were put on hold or canceled because of the COVID and current political issues in FIE. FIE did not approach the Council with any questions or requests for expertise on any matters during

the period from the last meeting. Dr. G. Tyshler proposed to follow up on all previous work done in the earlier years and the Council's prior proposals.

**Point 2 / Item 2 / Punto 2:**

Report of the COMEX representative, Mr. HAIBIN WANG - Executive Committee Member on COMEX meetings in 2022 – 2023.

Mr. H. Wang proposed that FIE allow two people to be in the “coaches box” during the individual and team competitions. It is essential, as many countries use foreign coaches and need a translator with the coach at the box.

There is a lot of politics in the FIE concerning the Russian and Belorussian athletes. It was many discussions involving the lawyers, etc. The proposal is to concentrate on our job as coaches and members of the coaching council to keep our sport alive. After the Paris Olympics COMEX, the newly elected will deal with all political problems.

One of the important matters is the Calendar for seniors and Junior fencers, especially for the period after the Paris Olympic Games. Our Council must actively create a new Calendar, including the Olympic qualification system for the next Olympic Games.

The Council needs to keep working and concentrating on our projects and decisions.

We have another year to go.

Unfortunately, the FIE refereeing committee does not want to meet with us.

**Point 3 / Item 3 / Punto 3:**

Proposals for FIE Congress

Proposals were discussed. Coaches opinions on the proposals are attached in a separate document.

**Point 4 / Item 4 / Punto 4:**

General discussion on fencing development and coaching council goals and targets.

Proposals – Decisions

1. Two people should be allowed to be in the “coach box” during the individual and team competitions.
2. Coaching Council requests that meetings in person for Council members be organized at least once a year. Zoom meetings cannot substitute in-person meetings and can be only additional follow-up meetings.
3. Representatives from the Coaching Council must be included in the working group for creating the Fencing Calendar after the Paris Olympic Games and discussing the Olympic qualification system.
4. During the competition, the scoring machines must operate only in “competition mode,” not in “training mode”; when the scoring apparatus automatically adds points to the score, it is unacceptable.
5. The coaching council and FIE must follow up on proposals and decisions sent to COMEX considerations.

**Point 5 / Item 5 / Punto 5:**

Follow up on the previous proposals

- 1. THE AGE OF PARTICIPANTS AT CADETS AND JUNIOR EVENTS**

The age of participants at Junior and Cadet competitions during the Junior and Cadet season was discussed. All coaches have the same vision on the cadets and junior participation. The rule o.30 should be strictly applied. The Council decided to approach the rules commission and legal commission to clarify the definition of the Junior and Cadets season.

“It is unfortunate, but every few years we have a problem with the age of participants at the junior and cadet local competitions in different countries.

Age of participants: o.29, o.30

We discussed the matter at the coaching council meeting and all coaches agree with the rule o.30. However, we have parents and fencing officials who have never fenced and interpret the rules differently.

Please help with correcting the interpretation of the rules or help us to find the place in the rules that clarifies the situation.

Maybe we need to add a definition for Junior fencing season to the rules. From Junior WC to the next Junior WC, or from April to April, or that the junior fencing season starts from the first Junior competition after the World championship.

Your help will be greatly appreciated.”

“First of all I want to thank everybody who is taking part in this discussion. Special thanks to Bruno Gares for the time he spent on putting together all pieces of the “Age of participants” matter from different parts of the rules into one document.

The FIE is not a closed corporation or business. The FIE is a Sports Federation and the main aim of the FIE is “to promote the development of fencing in the world” and “to improve the practice of our sport in every way”. The Federation should look not only after fencers who have paid the license, but for all fencers in the world including those, who are between 13 and 15 years old, with parents as their representatives.

Dear Nathalie, you are absolutely right in what you’ve written, taking extracts from the FIE rules. But this is the problem that we are talking about.

- Request to look at this matter is not coming from the amateurs or volunteers, but from the FIE Coaching Council, the FIE experts committee, that represents the fencing community from professionals at the international level and coaches working with the fencers on the ground. We have discussed the matter with other coaches from different countries and discussed it during the FIE Coaching Council meeting in June 2022. All members of the Council have the same opinion on the matter.
- Sport season. I am not going to talk about other sports, but in fencing, season is the period from one main FIE competition of the year, World Championships (Olympic Games) to the next one the following year. From July of one year to July of the next year, for example. A

Sport season is divided into periods. The transitional period (in our case it is August), the preparation period, the pre competition period and the competition period. Periods are divided in to macro cycles and then micro cycles. The Senior fencing season is from July to July. The Junior and Cadet fencing season is from April to April. Please do not mix the competitions Calendar with the fencing season.

- Calendar. Junior FIE competitions calendar is from November to April. This does not mean that juniors do nothing for the rest of the year. Fencers are training, having training camps, different kinds of competitions and other events. Cadets FIE competitions calendar has only one competition. But it does not mean that fencers, cadets, do not fence during the year or do not have a fencing season. Cadets and Juniors can take part in Senior competitions as well.
- The most serious cheating in the sport is doping and manipulating with age. This is absolutely clear to anybody who fenced as a cadet and a junior, or fencers and their representatives (coaches, parents of fencers) who took part in “ranking” and “selection” competitions. It is especially important in fencing, where we have direct elimination system, seeding before competitions and after the pools.
- Dear Nathalie, you are absolutely right o.30 rule is correct. o.30. Only fencers who are of an age to qualify for the next Junior World Championships may fence in the official FIE Junior competitions, individual or team, of the current season. This is exactly what we’re all talking about, but we need to clarify this rule clause for the WORLD FENCING community, especially for people who learned fencing “from the book” and have never fenced cadet or junior competitions themselves, that we have a Senior season AND a Junior and Cadets season, And that the fencer, who moved to the senior category after his last Junior World Championship in April, should not take part in any Junior ranking and selection competitions any more. New cadets and junior age groups should start training and competing together, preparing for the next major event.
- The Current situation is unfair for the younger kids and does not meet safeguarding requirements. The situation is opening possibilities for “manipulation of results” and “corrupt conduct”. As participants who are “over age” (not eligible for selection for the next world championship) can manipulate the ranking, results and selection. To make it straight forward, they can sell their bout to fencers who need the ranking and selection.

We need to and can help Confederations, Federations, THE WORLD of fencing by putting a few words in the FIE rules to make this absolutely clear. This will not have any impact on the current FIE procedures and will not harm anybody. I think that the FIE rules and legal committees can find the right way to address the problem.

Example:

o.30. Only fencers who are of an age to qualify for the next Junior World Championships may fence in the official FIE Junior competitions, individual or team, of the current JUNIOR season (1st May to 31st of April next year).

## **2. JUNIOR AND CADETS WORLD CHAMPIONSHIP COMPETITION PROGRAM**

Coaches discussed the program for the Cadets and Junior World Championships. All agreed that the Cadets event should be organized before the Junior event.

## **3. HALL SET UP AT MAJOR FIE EVENT**

The most important person in sports is the athlete. During competitions everything should be done to help the fencers compete comfortably and achieve the best possible results. It has come to our attention that at the last few competitions, organizers, during the preliminary stage of the competition, blocked all competition areas with a fence, not allowing fencers access to their coaches between the bouts during preliminary pools stages. This situation is unacceptable. Fencers should have easy access to their coaches advice between their bouts during pools. Additionally, the blocked area was very big and the lights on the scoring apparatus were not visible from all directions. We want to mention that pools are the preliminary stage of the event and the official competition will start only after the opening ceremony with direct elimination and spectators.

A coach usually has 4 fencers competing in the pools. Easy passage should be organized from one side of the arena to another.

We think that the matter is clear, competitions should be organized according to the rules, handbook of regulations and traditions of our sport.

Another solution may be to allow the coach at the piste during the bout of his fencer as is during direct elimination.

### **Point 6 / Item 6 / Punto 6:**

Joint meeting with FIE Athletes commission.

The coaching council had a joint meeting with the Athletes Commission. The meeting went well. Everybody agreed that athletes and coaches must cooperate more and create joint proposals for the FIE.

## **CONCLUSION**

Dr. G. Tyshler thanked everybody for the work done. A draft of the minutes will be circulated by the president to all members for comments. The date for the next meeting will be announced.

Meeting closed.

7th July 2023



## MEETING MINUTES FOR FIE- FAIR PLAY COUNCIL

DATE: August 3, 2023 15:00CET

### ATTENDANCE

#### Present

- Bert Van der Flier (MH), NED – President of the Council
- Eyyad Maghayreh, JOR
- Jennifer Yamin, USA

#### Absent and excused.

- Hilary Philbin, GBR
- Oleg Peskov, KAZ – COMEX Representative
- Marcel Amougou, CMR
- Alejandra Benitez Romero, VEN
- Osmonzhan Kasymov, KGZ

### Meeting minutes

1. Jennifer Yamin was contacted by Mr. Bert Van der Flier, President of the Council when he faced a technical problem setting up a Zoom call link for the council meeting. Jennifer Yamin sent a meeting link to the council members two hours before the meeting. However, due to the short notice, only Mr. Eyyad Maghayreh from Jordan, Mr. Bert Van der Flier, and Jennifer Yamin could attend the call.
2. During the call, Mr. Van der Flier recommended Mr. Lachlan Crook from Australia as a candidate for a sportsmanship certificate. This was due to Mr. Crook's acknowledgment of self-hitting during an epee match against Max Heinzer (Sui) at the Milan world championships. To support his recommendation, Mr. Van der Flier shared a YouTube video of the match between Mr. Crook and Mr. Heinzer, showcasing Mr. Crook's admirable sportsmanship.

[https://www.youtube.com/watch?v=SVQP\\_\\_EYFQI](https://www.youtube.com/watch?v=SVQP__EYFQI)

3. Jennifer Yamin also nominated a fencer, Maria Akshita Ciril Rajdev from India, for the certificate award. During the WF pool round, Maria had given up her electric jacket for an AIN fencer, Layla Pirieva. Although Jennifer Yamin had asked her to help another fencer, Maria took her electric jacket off without hesitation.
4. All three attendees agreed that Mostafa Tahoun (CMF, Egypt) had the most compelling story and nominated him for this year's award winner. Mostafa had participated in the Plovdiv junior cadet world championships. Mr. Van der Flier requested Jennifer Yamin to send meeting minutes along with the email to the rest of the council members to ask for their input regarding Mr. Mostafa Tahoun as the final candidate for this year's Fair Play award winner.

Colors	11:20	11:35	11:50	12:50		FILE	DRAW	RESULTS ON plates
7-8	13:10	13:25	13:40	14:40	TB	1	colors	14:10 14:25 14:40
7-8	14:40	15:10	15:10	16:10	T 5-8	1	7-8	15:40 15:55 16:10

16:10  
17:40 Bronze M  
18:40 WF F  
19:40 MF

PROPOSAL FOR FAIR-PLAY

TAMOUN MOSTAFA EGY.

In a fight with PARK SANGWON KOR PARK lost all WEAPONS AND TAMOUN GAVE HIM HIS WEAPON TO FINISH THE BOUT. PARK WON.

HIROSE TOMOKO

Cadet Men's Foil

Cadet World Championship Ploudiv

April 5 2023

DE Round of 64

## MEETING MINUTES FOR FIE- FAIR PLAY COUNCIL

DATE: JULY 8, 2023, 15:00 CET

### ATTENDANCE

#### Present

- Oleg Peskov, KAZ – COMEX Representative
- Bert Van der Flier (MH), NED – President of the Council
- Marcel Amougou, CMR
- Alejandra Benitez Romero, VEN
- Osmonzhan Kasymov, KGZ
- Eyyad Maghayreh, JOR
- Jennifer Yamin, USA
- Elena Murdaca – FIE Administration Director/FIE office representative

#### Absent and excused.

- Hilary Philbin, GBR

#### Meeting minutes

1. Opening by the President. Bert Van der Flier opens the meeting with greetings.
2. Ms. Hilary Philbin was unable to attend the meeting due to health reasons.
3. Mr. Van der Flier asked if anyone had objections or comments from the last meeting. – No objections or comments from the members.
4. As of now, Mr. Van der Flier still needs to discuss the candidates for the fair play award for the 2022-2023 season with the FIE interim President. He suggested waiting until after the Milan senior WCH to see if additional candidates emerge. Furthermore, he proposed recognizing individuals for reasons beyond just self-reporting after a self-hitting in epee.
5. Jennifer Yamin recently shared the name of a Fair Play nominee, Mostafa Tahoun (CMF, Egypt), who participated in the Plovdiv junior cadet world championships. A Japanese referee filled out the nomination form and sent it back to Jennifer Yamin, who was working as a DT at the junior & cadet world championships. To date, Mostafa Tahoun is the only candidate for the award this season. During the CMF individual T-64 fencing match in Plovdiv, Mostafa, a fencer, showed sportsmanship by sharing his weapons with his opponent, Park from Korea. Unfortunately, Mostafa lost the bout in the end.
6. The Women's Council suggested more precise wording for T109, but most members have yet to reply. Jennifer Yamin shared Elena Murdaca's email with all council members, and Mr. Van der Flier gave everyone until the end of the day to respond. All members have favorably received the proposal put forward by the women's council.

7. Alexandra Benitez Romero proposes creating a video compilation highlighting unfair play instances. She has shared unverified YouTube videos featuring athletes exhibiting poor behavior after losing matches.
  - Jennifer Yamin disagrees with this approach and believes that our focus should be on promoting positive images and fostering good sportsmanship by educating families involved in fencing. Uplifting spirits by sharing videos of good sportsmanship is the direction our council should be focusing on. Jennifer Yamin believes that pointing out someone's mistake may negatively affect the relationships between our council and federations.
8. Alexandra Benitez Romero proposes having the Fair Play Council review the black card cases.
  - Jennifer Yamin advised that It's important to note that altering the FIE status or regulations would require a proposal submitted within the time frame for approval. Additionally, Jennifer Yamin is unclear whether the Fair Play Council has the authority to penalize athletes or individuals who receive a black card, as there is already a disciplinary panel to handle such matters.
9. Budgetary constraints have hindered the project of creating a promotional video for fair play. However, Marcel, Alejandra, and Jennifer have suggested using social media as an alternative way to promote Fair Play without putting a strain on the budget. Mr. Bert Van der Flier has asked Mr. Peskov to inquire whether it would be possible to use the FIE logo on social media. Mr. Peskov will request the FIE office to add this request to the agenda for the upcoming COMEX meeting on July 22.
  - As a follow-up, the council has received approval to use the FIE logo on the Fair Play Council's social media account. We still need to address the specifics of creating the social media account.
10. Jennifer Yamin proposed that the FIE communication department assist our council in interviewing previous award winners who will be attending the Milan world championships. Mr. Bert Van der Flier requested that Jennifer Yamin contact Serge Timacheff, who is currently in Phoenix for the US summer national tournaments, where Jennifer was also attending.
  - After speaking with Serge Timacheff, Jennifer Yamin contacted Zhen Ma at the FIE communication department to request assistance with interviews and social media coverage for our council's initiative. Zhen Ma and Serge Timacheff were eager to help and agreed to cover the council's efforts.
11. The next meeting is proposed on 8/3 at 15:00 CET to discuss additional candidates for the fair play award.

**RAPPORT DU CONSEIL DES VETERANS DE LA FIE**  
**FIE VETERANS' COUNCIL REPORT**  
**INFORME DEL CONSEJO DE LOS VETERANOS DE LA FIE**

<b>Date, lieu et heure de la réunion :</b> <b>Date, place, and time of the meeting:</b> <b>Fecha, lugar y horario de la reunión:</b>	<b>July 7<sup>th</sup>, 2023 via Zoom</b> <b>Start 13:00 CET</b> <b>End 18:00 CET</b>
<b>Participants:</b> <b>Participants:</b> <b>Participantes:</b>	1. Benoit PINCEMAILLE (Pres.) 2. El Houssine AMEZIANE 3. Mirna BOROSAK 4. Peter BRIGOLA 5. Rit COMES 6. Kovacs LIN 7. Mohamed NAHI 8. Marja-Liisa SOMEROJA
<b>Absences (indiquer si l'absence avait été annoncée) :</b> <b>Absent (indicate if the absence had been announced):</b> <b>Ausencias (indicar si la ausencia fue anunciada):</b>	1. Velichk HRISTEVA 2. Luis FILARDI (part of the technical team of the Central American and Caribbean Games – cannot attend) 3. Jie DENG (got injured during exercise – cannot attend)

**INTRODUCTION**  
**INTRODUCTION**  
**INTRODUCCIÓN**

The meeting with the Women and Fencing Council was brought forward at the request of the Veterans Council.

40+ and 70+ at FIE Veterans World Championships:

In order to be able to compare the effect of 40+ and 70+ participation of women, Benoit will provide the statistics of the last 10 years of European tournaments. The Women and Fencing Council will feature 40+ and 70+ female fencers in FIE tournaments on social media together with the promotion commission. The aim is to show how joyful and happy veteran fencers can be.

After the meeting with the Women and Fencing Council, Benoit welcomed everybody again and started to follow the agenda.

**RAPPORT DE LA RÉUNION**  
**MEETING REPORT**  
**INFORME DE LA REUNIÓN**

**Point 1 / Item 1 / Punto 1: Opinion of the Veterans Council about the Modifications of organisation and technical rules**

- The Veterans Council agreed with the changes of the organization and technical rules.

**Point 2 / Item 2 / Punto 2: Forthcoming World Veterans Championships DAYTONA 11 -16 October 2023**

- Rita Comes – report in annex.
- Preview of the World Championships in Dubai 2024  
Benoit showed a Video from the Junior and Cadet World Championships 2022 and did a comparison to the upcoming Vet World Championships 2024.

### **Point 3 / Item 3 / Punto 3: Main recent activities of veterans in the Confederations**

#### Europe

- European Championships (Power Point presentation of Benoit see annex)
- EVF circuit (Power Point presentation of Benoit see annex)

#### America

- Rita Comes – report in annex.

#### Africa

- Mohamed

Mohammed reported that there were no activities in veteran fencing as well as cadet and junior fencing in Africa

#### Asia

- Kovacs

Due to COVID no Asian Vet championships have been held since 2019. Only a few nations held their national championships. Unfortunately, the Asia Confederation has very few activities. For 2024 the Asian Vet Championships are planned in Hong Kong and the same for 2025 in Singapore.

### **Point 4 / Item 4 / Punto 4: Should the "veteran" appellation be called into question?**

- The suggestion to change the naming to "Masters" was discussed intensively. In the end, this activity was switched to "Standby".

### **Point 5 / Item 5 / Punto 5: Do we want the Council to become a Commission?**

- The council believes that a group of COMEX-appointed members represents the views of veterans better than (elected) members of commissions.

### **Point 6 / Item 6 / Punto 6: Is the 60-year age limit for referees appropriate for veterans?**

- The Council has the opinion that the maximum age of the referees cannot be changed, because in any case at World Championships the referees are nominated by the FIE (from the master list). So, the maximum age of referees has to stay at 60 years.

#### Meeting with the Promotion Commission (Pres. Nikolay Mateev):

Dieter Lammer (FIE Technical director) and Ziad Feriani (Pres. FIE Rules Commission) also took part in this meeting.

- Test event to implement the 40+ category:  
At the 2025 World championships, the 40+ (all categories, genders and weapons) will be held to test the feasibility in all areas. After the positive conclusion, the 40+ category will be introduced regularly at world championships. After that clarification Dieter Lammer and Ziad Feriani left the meeting.
- Support of Promotion Commission for Veterans:  
The Promotion Commission will increase the posts on social media and are asking for standards at podium Fotos. It is very necessary to show not only the success or failure, but above all that fencing can bring happiness, especially to older athletes.

**Point 7 / Item 7 / Punto 7: Miscellaneous**

- Display of Veterans ranking on FIE website as other categories:  
After the World Championships in Milan, this topic will be discussed with the responsible persons.

Peter Brigola  
FIE Veteran Council  
Secretary



***EVF European Championships May 2023 THIONVILLE (FRA)***



**1462 fencers  
coming from 33 countries**



# Global organisation

Wednesday		Thursday		Friday		Saturday		Sunday	
<b>325</b>		<b>304</b>		<b>433</b>		<b>459</b>		<b>303</b>	
		<b>MS1</b>	40	<b>ME1 Poules</b>	138	<b>ME1 Tableaux</b>	138	<b>MF1</b>	64
<b>MF2</b>	77			<b>ME2 Poules</b>	224	<b>ME2 Tableaux</b>	224	<b>MS2</b>	60
<b>ME3</b>	156	<b>MF3</b>	62					<b>MS3</b>	46
<b>MF4</b>	32	<b>ME4</b>	83	<b>MS4</b>	23				
		<b>WE1</b>	82	<b>WF1</b>	33	<b>WS1</b>	20		
		<b>WF2</b>	37			<b>WS2</b>	35	<b>WE2</b>	105
<b>WE3</b>	47			<b>WS3</b>	15	<b>WF3</b>	24		
<b>WS4</b>	13					<b>WF4</b>	18	<b>WE4</b>	28

**37 Referees**

**30 pistes**

## Participation per countries



FRA	404
GER	283
GBR	137
ITA	124
HUN	79
BEL	46
SUI	43
POL	43
ESP	42
NED	35
SWE	35
AUT	34
FIN	31
UKR	16
ISR	14
DEN	12
GEO	11
CZE	10
OTH	63



# Categories and weapons analysis

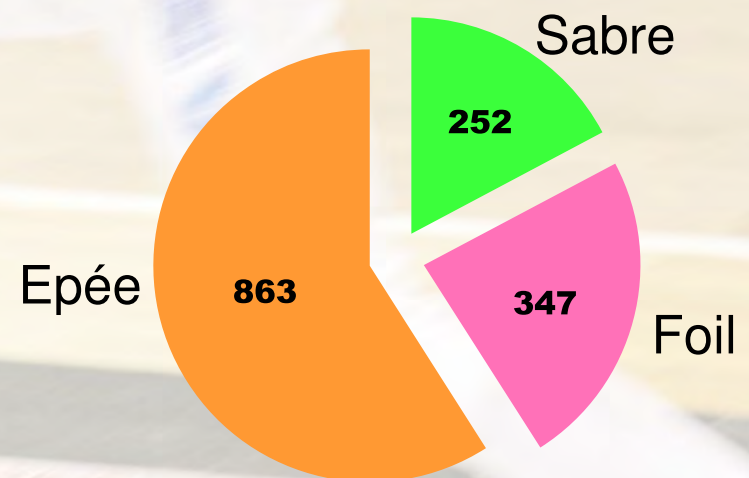
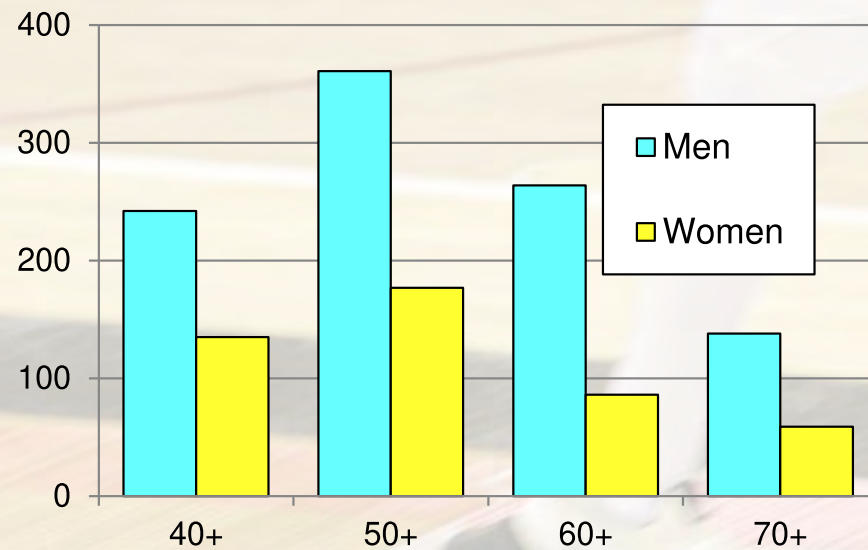



# Global results

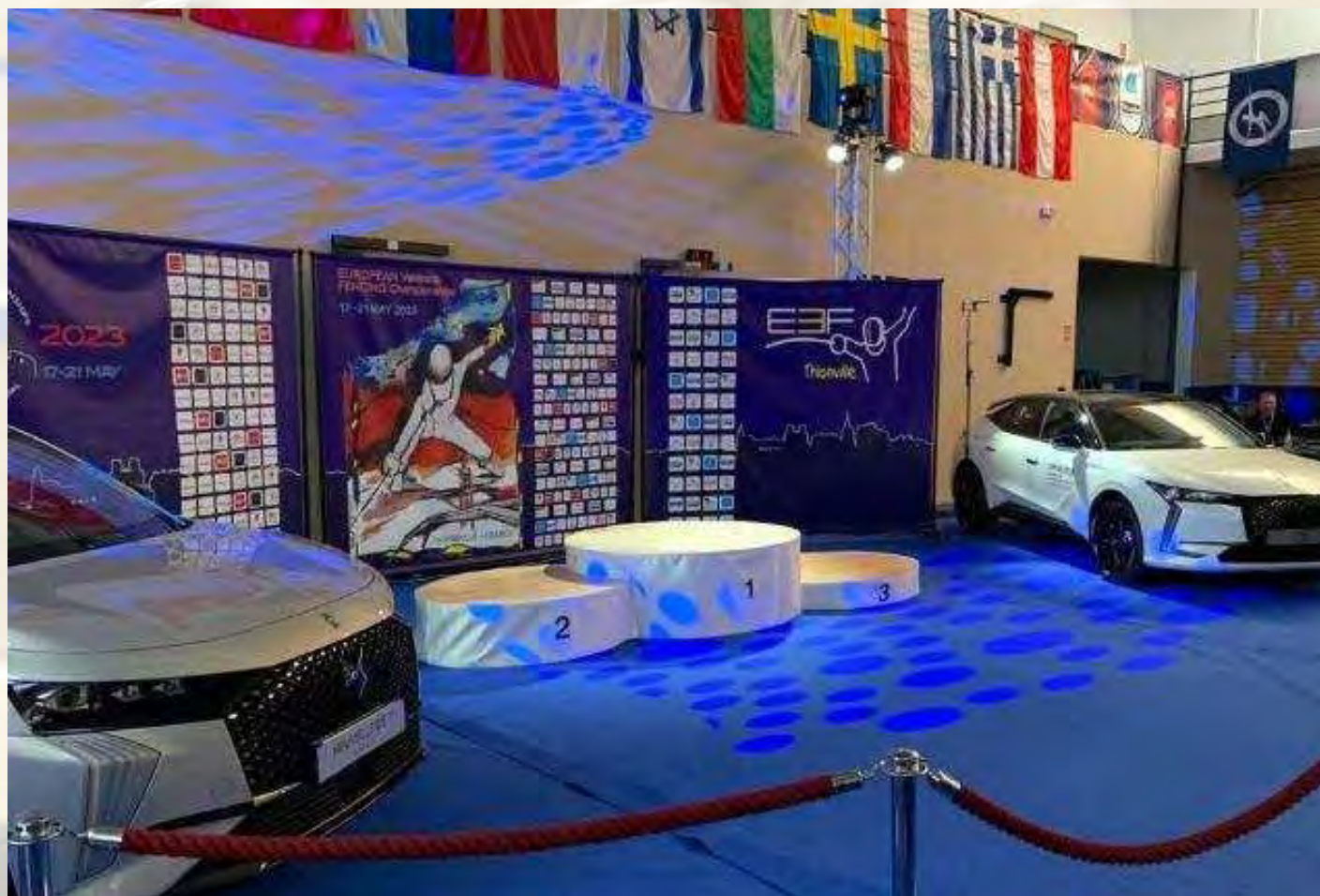

	old	Siver	Bronze	Total
FRA	6	6	14	<b>26</b>
ITA	4	6	4	<b>14</b>
GER	4	4	9	<b>17</b>
GBR	3	1	7	<b>11</b>
FIN	3		1	<b>4</b>
HUN	2	2		<b>4</b>
CRO	1			<b>1</b>
SWE	1		1	<b>2</b>
BEL		2		<b>2</b>
AUT		1	6	<b>7</b>
ESP		1	3	<b>4</b>
UKR		1		<b>1</b>
NED			2	<b>2</b>
LAT			1	<b>1</b>

## ***Forward-looking***

- **These Championships are APPRECIATED :**
  - ✓ Interest of local authorities
  - ✓ Hosting cities committed until 2027 !
- **The format 5 days / 30 pistes is APPROPRIATE :**
  - ✓ Can welcome up to 1800 fencers
  - ✓ Preserves the « open » concept
- **These Championships are PROFITABLE :**
  - ✓ Reasonable EVF requirements
  - ✓ Many partnerships opportunities



## ***EVF European Circuits***

- **Initiated in September 2018, encouragingly successful.**
- **Interruption 2020 /2021 due to Covid ...**
- **Season 2022 / 2023 :**

**12 Hosting cities**  
**More than 2000 entries**

# EVF European circuit 2022-23 - Geographical distribution

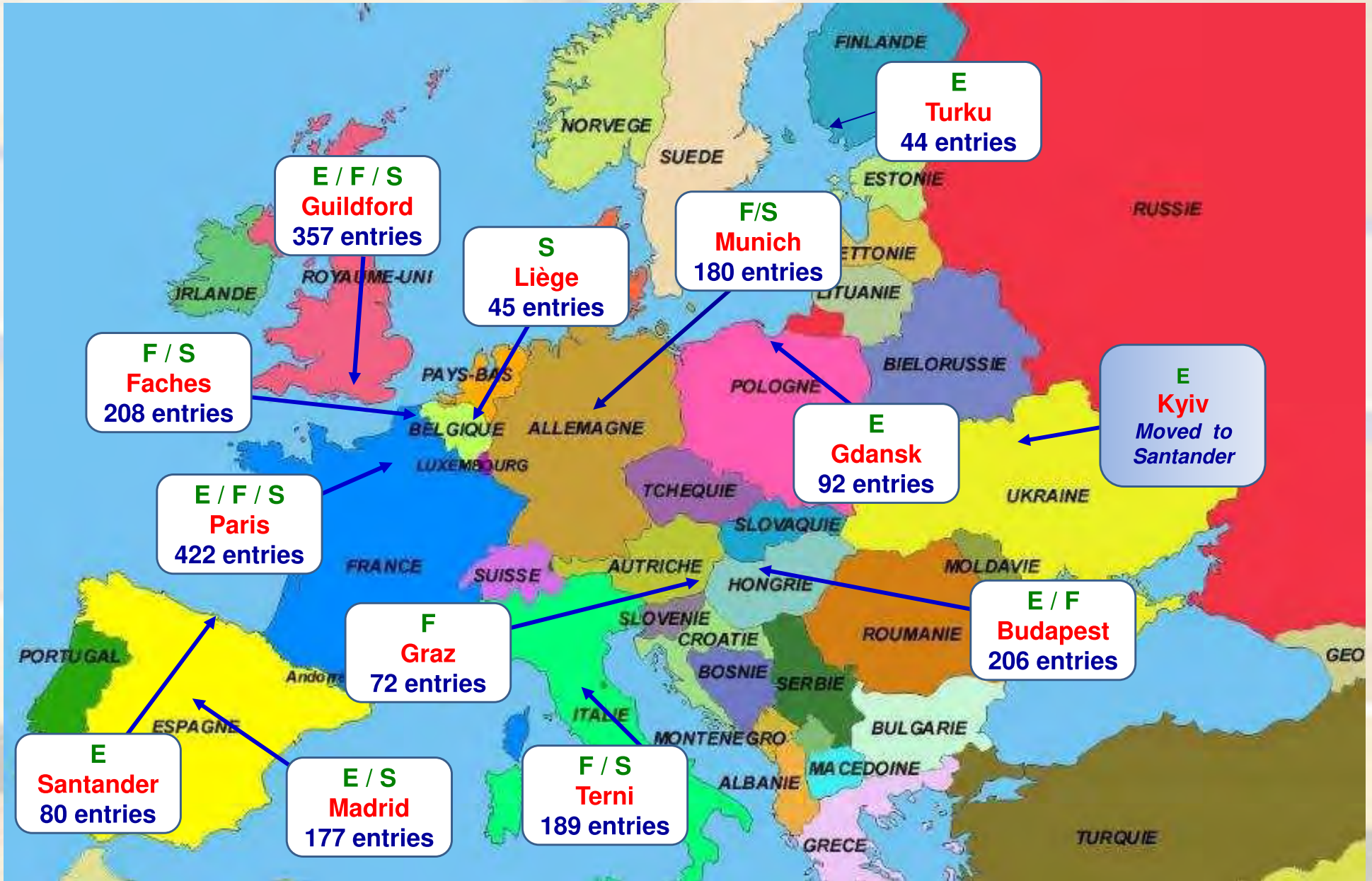



## Participation analysis per countries

entries

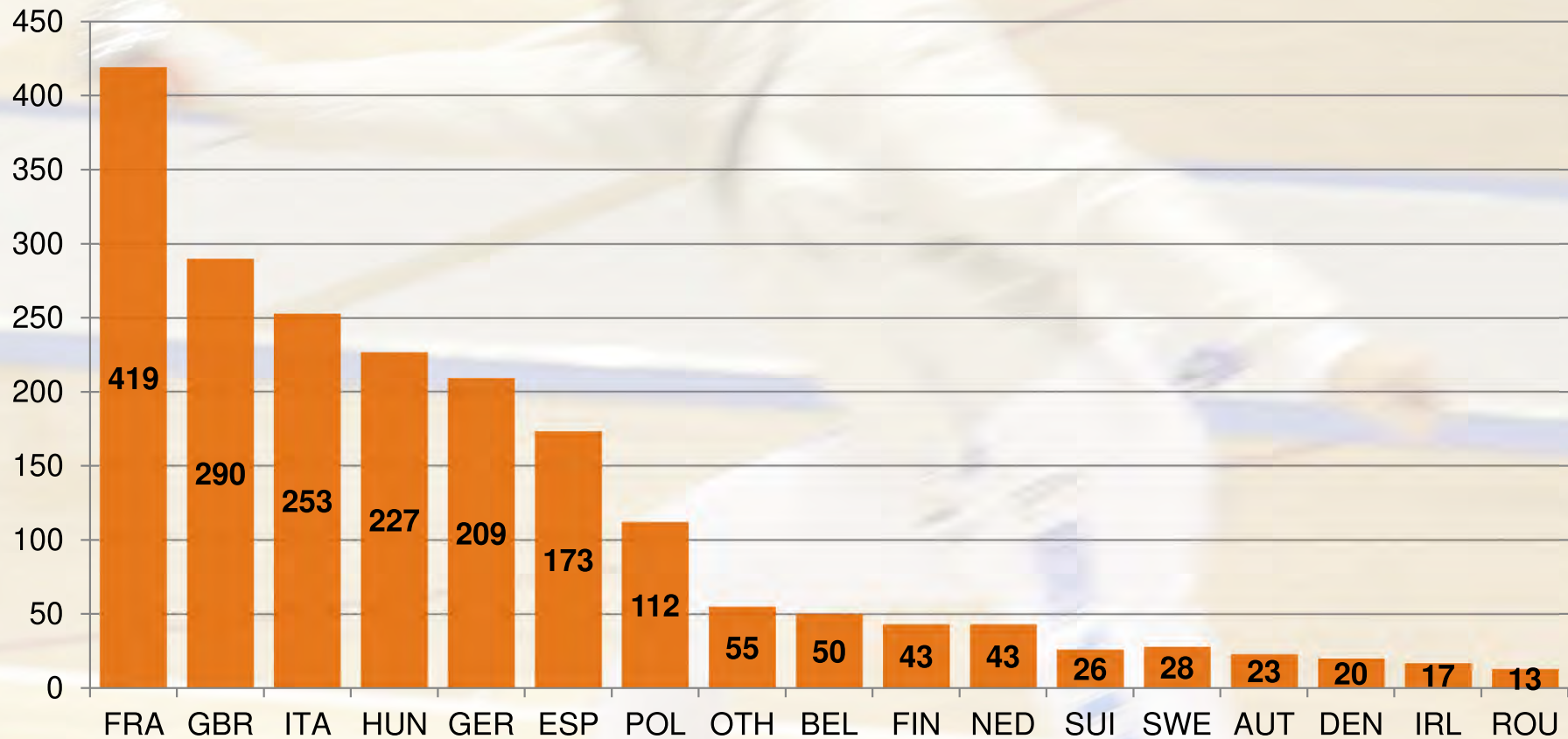

**2072** entries of **1328** fencers  
coming from **36** countries



## Participation analysis per hosting cities

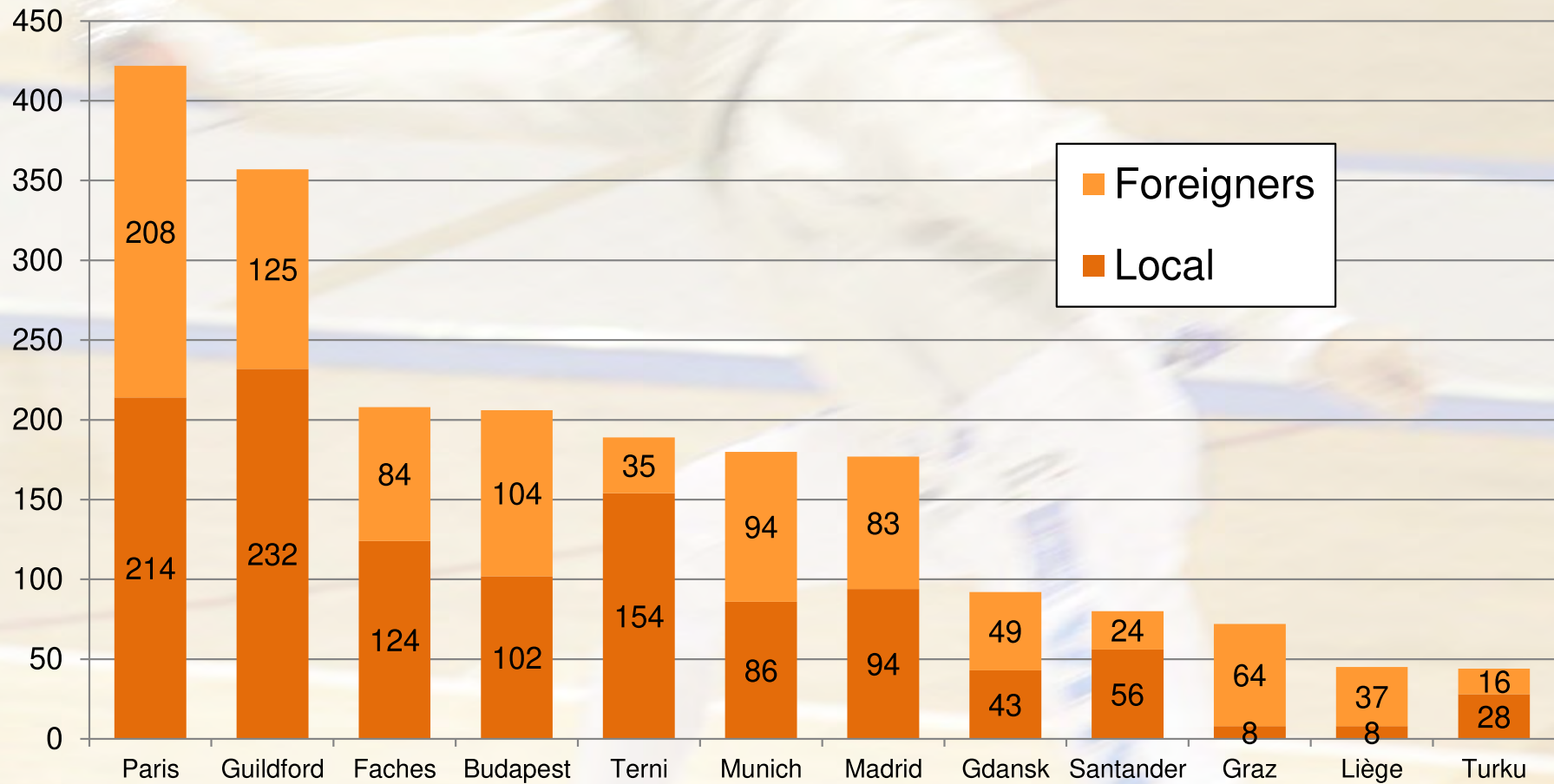

➤ **Fencers are not afraid to go abroad !**

# Categories an weapons

Distribution of the 2072 entries :

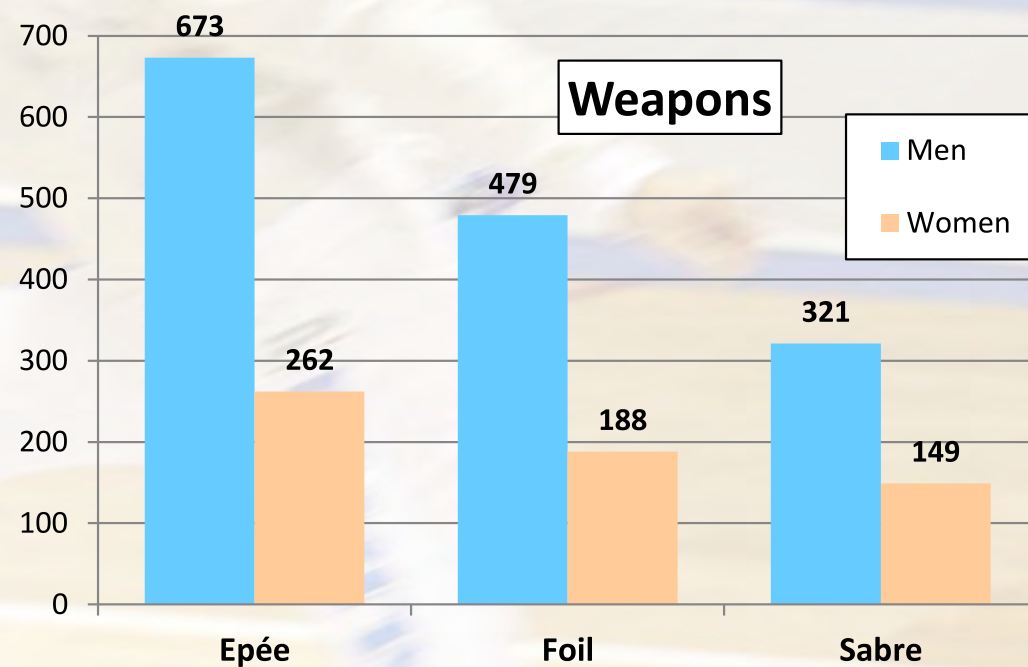
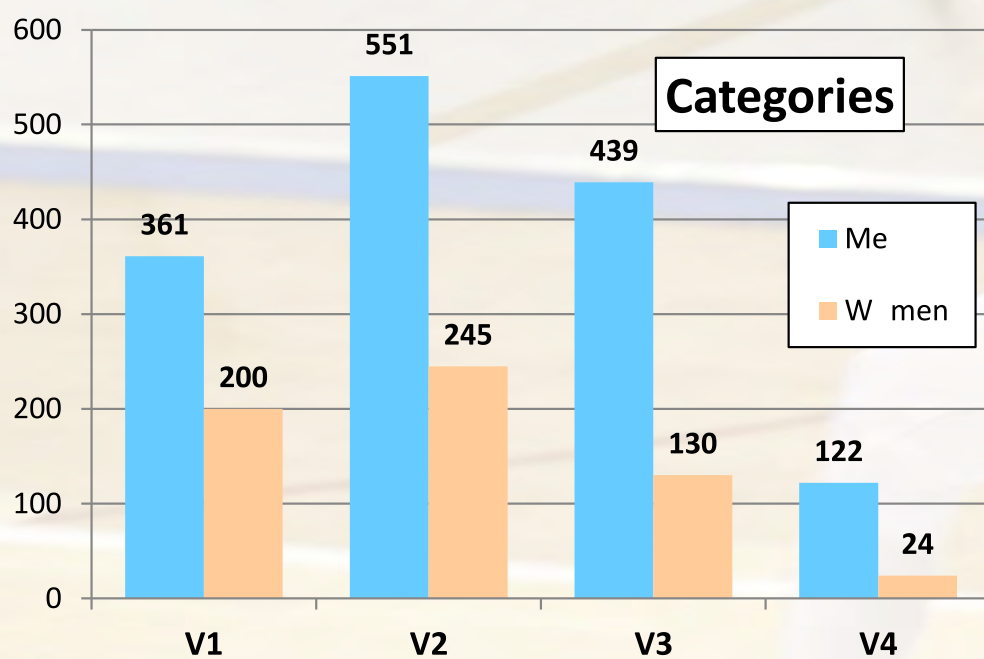

## Creation of an individual ranking

- Points according to the place (logarithmic scale) e.g :
- Ranking by addition of the 5 best results, the last 2 years (sliding mode).
- 2348 fencers have a ranking :

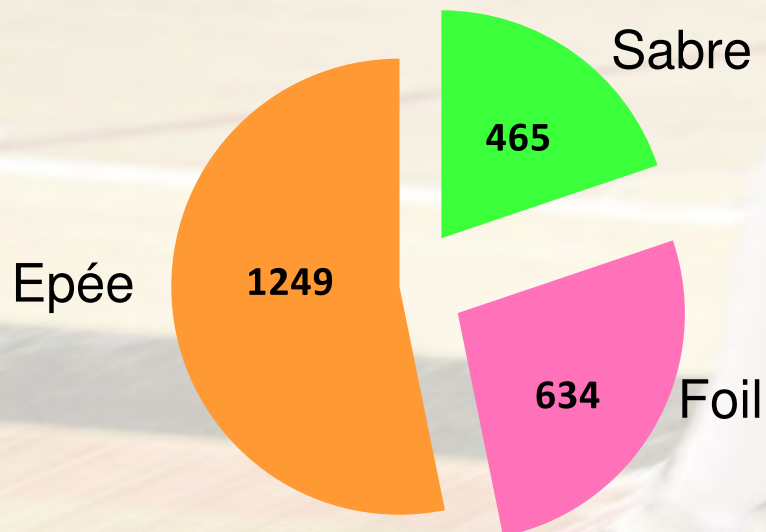
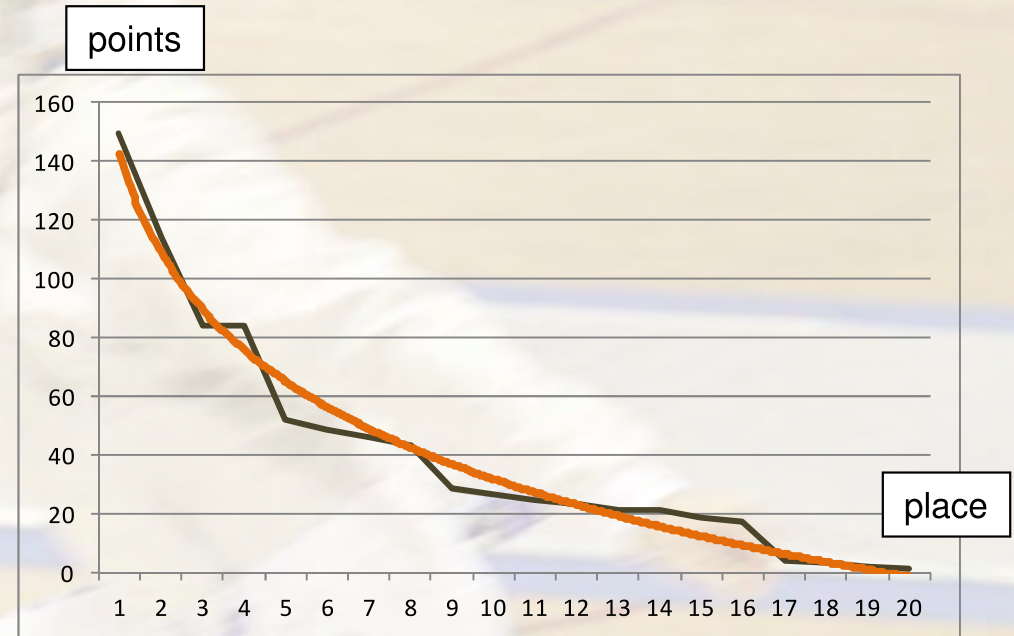

*At the end of the season, the best fencer in each category, weapon and gender is :*

**FENCER OF THE YEAR !**



# EVF European Circuit 2023-24 - Provisional Calendar

		2023					2024					
		JULY	AUGUST	SEPTEMBER	OCTOBER	NOVEMBER	DECEMBER	JANUARY	FEBRUARY	MARCH	APRIL	MAY
FRA	Paris	FOIL + EPEE + SABRE										
ESP	Madrid					FOIL + EPEE + SABRE						
ITA	TBD						FOIL + EPEE + SABRE					
BEL	Liège										SABRE	
HUN	Budapest			FOIL + EPEE + SABRE								
GER	Munich						FOIL+SABRE					
FRA	Faches							FOIL+SABRE				
AUT	Graz									FOIL		
FIN	Turku			EPEE								
GBR	Guildford							FOIL + EPEE + SABRE				
GRE	Athens										EPEE	
POL	Gdańsk										EPEE	
SWE	Stockholm								FOIL + EPEE			

WORLD CHAMPIONSHIPS

EUROPEAN CHAMPIONSHIPS

## **2023- USA – Prepared by Rita Comes – Member of the FIE Veteran Council**

The number of Veteran Fencers in the United States has continued to increase. Veteran National Events and Regional Events are well attended by the Veteran Fencing Community. United States Fencing Association Members include Senior, Youth, Veteran and Para Fencers as one united organization.

It was unfortunate that the 2021 FIE Veteran World Championships had to be postponed due to the world Covid crises. We recognize the hardship and loss that so many suffered during this crisis. We are extremely excited to host the 2023 FIE Veteran World Championships in Daytona Beach, Florida during October 2023. All information – the website and invitation letters for the 2023 FIE Veteran World Championships have been published and forwarded to all Federations.

The United States Fencing Association (USFA) currently has about 39,000 (38,289) members. 3,936 are identified as Veteran Fencers. Veteran Fencers represent more than 10% of all USFA members. There are 626 individual Veteran Fencers that are competing in a variety of events during the 2023 USA National Championships in July – 19 of those Veteran Fencers are over the age of 80. The 2023 National Championships and July Challenge in Phoenix, Arizona had over 5,300 participants and is considered the largest fencing tournament in the world.

### **Team Participation**

Veteran Team Events have increased over the years. Many competitions are adding Veteran Team Events to Local and Regional Events. This has been proved a successful addition for marketing and profitability at competitions. The US will demo the FIE Veteran's Team format at a future event.

### **Veteran Camps and Competitions**

There has been a significant increase in Veteran workshops, Camps and Veteran Competitions across the United States with members traveling long distances to participate. Many Veteran Fencers are able to attend camps and competitions around the world and have appreciated the openness and help of the world fencing community. An increase of Regional (ROC) events in the US allowed for reduction of travel expenses and more participation of the fencers to compete and qualify for the US National Championships without having to travel to National Events during the year. There is an increasing number of Veteran Fencers that continue to participate in tournaments around the world and use these opportunities as a destination travel event.

### **Strategies for promotion of “older fencers”**

Regarding the strategies for promotion to “older fencers” our largest initiative has been starting the V80 category at our North American Cup (NAC) events since December 2018. As predicted, the Vet80+ women's participation has continued to increase in the US. The participants of the 80+ Events are very grateful for the experience, but more information will have to be gathered from other Countries before proposing to seriously consider suggesting that it be included as an event at the FIE Veteran World

Championships.

USFA has also increase the Social Media presence for Veteran Fencing - interviews, photos, memorabilia, and historical stories have really helped promote the image of Veteran Fencing.

A private USA Fencing Veterans Face Book (FB) page (1,900 Members) that was started in 2018 has grown by an additional 400 members in the past year. This page is used so that official and fun information could be shared amongst the Veteran Fencers around the world, there is also a private US Women's Veteran FB page (617 members). During the pandemic, a Veteran Women's Fencing Support Group was formed and had weekly then bi-monthly and now monthly Zoom meetings to support each other during this difficult time.

In leading up to the 2023 FIE Veteran's World Championships, we have an eager team of competitive fencers that fought their way for the spots on the USA Veteran Team. The Team has high hopes of receiving another recognition medal from the FIE for the 2023 Event as it did for the 2022 FIE World Championships. Promotion for the Daytona Beach, Florida Event and Veteran Fencing overall has brought a lot of attention to Veteran Fencing in the US and beyond.

We look forward to welcoming the World to Daytona Beach in October.



**RAPPORT DU CONSEIL FEMME ET ESCRIME DE LA FIE  
FIE WOMAN AND FENCING COUNCIL REPORT  
INFORME DEL CONSEJO MUJER Y ESGRIMA DE LA FIE**

<b>Date, lieu et heure de la réunion :</b> <b>Date, place and time of the meeting:</b> <b>Fecha, lugar y horario de la reunión:</b>	<b>7th July - 1pm CET – 4pm CET</b> <b>8th July - 1pm CET – 4pm CET</b>
<b>Participants:</b> <b>Participants:</b> <b>Participantes:</b>	1. Maria Cristina BATE 2. Mirani FERNANDES 3. Caitlin FOX-HARDING 4. Helen SMITH 5. Michael STAFFORD 6. Christina VLACHOUTSIKOS 7. Georgina USHER
<b>Absences (indiquer si l'absence avait été annoncée) :</b> <b>Absent (indicate if the absence had been announced):</b> <b>Ausencias (indicar si la ausencia fue anunciada):</b>	1. Melissa Elisabeth ALVARENGA (Advance Apologies) 2. Svetlana PETRONIJEVIC (Advance Apologies) 3. Ahmed GANA 4. Huda AL MATROOSHI

**INTRODUCTION  
INTRODUCTION  
INTRODUCCIÓN**

GU welcomed attendees, especially those for whom the time difference meant anti-social hours. It was noted that it is much harder for the Council to work given that we no longer meet face to face. Some members are able to attend events in their other capacities so the reality will be that in person connections will be opportunistic and ad-hoc.

**RAPPORT DE LA RÉUNION  
MEETING REPORT  
INFORME DE LA REUNIÓN**

**Point 1 / Item 1 / Punto 2: Review of Commission and Council Proposals**

The Council reviewed the proposals in advance of the meetings with other Commission and Councils.

**Point 2 / Item 2 / Punto 2: Council Strategy Review**

The Council discussed the high-level strategic objectives and confirmed they remain appropriate:

- A Communication Plan based on Inspiring Content
- B Collaborate with identified Commissions/Councils/Exec to ensure that equal opportunities and inclusive environments exist across all areas. (Both in terms of access to training and in terms of assignments to competitions.)
- C Collaborate with other (NF, Zonal) Women and Fencing Councils
- D Provide access to Education & Training



- E Supporting Initiative - Safeguarding - creating inclusive environments
- F Supporting Initiative - Research, Data, Evaluation
- G Supporting Initiative - Investigating the possibility to broaden remit of council to reflect broader remit of equality, diversity and inclusion.

### **Point 3 / Item 3 / Punto 3: Work Plan Review**

#### **A Communications**

Update – MF updated the Council on her activities on Facebook and Instagram. Audience and engagement is growing but more content is required. Desire to include interviews/testimonials but there's hesitancy to engage with the sensitivity and polarisation of the world.

#### Follow Up Actions

- Together we are stronger theme – everyone to create a video
- Interview with Georgina, Iris, Helen post congress
- Cross post with the FIE main account
- GU to put together international series of fencing interviews (in writing) via British Fencing media team.

#### **B Collaborate with identified Commissions/Councils/Exec**

Update:

HS & GU have been engaged in ongoing discussions with representatives from Refereeing Commission in relation to proposals to secure minimum gender representation and collecting gender data.

GU, HS & CFH have been engaging with the Medical Commission in relation to the IOC Framework on Fairness and Inclusion

C Collaborate with other (NF, Zonal) Women and Fencing Councils

Update - GU & MS met with representatives from African Fencing Confederation. CV reached out to EFC Council and will keep trying to arrange a meeting supported by GU.

Action - GU to request update from HaM (Aisa) and MA (Panamerican). HS to organize a meeting between GU & Oceania Equality, Diversity & Inclusion Commission.

D Provide access to Education & Training

Update - MCB & CFH attended ASIOF Leadership Course

Action – Follow up with article for website.

E Supporting Initiative - Safeguarding - creating inclusive environments

Update – Training continues at FIE (e.g. Safeguarding Policy creation), Confederation (e.g. EFC Event Safeguarding Officer) and National (e.g. Greek Fencing Federation). MF working with IWAS to promote safeguarding in Wheelchair fencing.

F Supporting Initiative - Research, Data, Evaluation

No specific update.

G Supporting Initiative - Investigating the possibility to broaden remit of council to reflect broader remit of equality, diversity and inclusion.

No specific update.



Action – HS & GU to raise this with FIE.

#### **Point 4 / Item 4 / Punto 4: Meeting with Veteran Council**

##### **Notes**

- The Veteran Council noted that gender diversity is generally increasing.
- They support the proposals which focus on the organisation (DT, medical, referees)
- The Veteran Council raised concern in some of the younger (40-49) veteran age cohorts participation seems to be dropping (potentially due to family or work obligations)
- Similar issue with some of the older age cohorts (70+) competing among the same cohort
- Discussion on how the Councils could work together to address this.

##### **Arising Actions**

- Veterans council members to meet with Mirani to discuss using world championships to highlight what is to come in the future with increased category 40+
- Georgina and Rita Comes to liaise regarding stories of increasing participation numbers regionally
- Benoit Pincemaille to send Georgina the data he's collected on men and women.

#### **Point 5 / Item 5 / Punto 5: Meeting with Promotion, Communication and Marketing Commission**

##### **Notes**

- The PC&M Council noted that they did not receive a copy of the W&F Council proposals.
- Regular communication with the press about diversity/inclusion/etc is recognised as positive.
- Decision to move the magazine, Escrime, to an online platform could provide more opportunity for W&F Council content to be featured.
- There was a discussion about adding a paid diversity officer to the FIE staff, in reflection of the importance of the topic. Questions around how this would overlap with safeguarding initiatives which are also designed to create safe inclusive environments. (Currently safeguarding is not a separate paid staff role)
- Women in Fencing to obtain a PD of the role at USFA for inspiration.

##### **Arising Actions**

- MF to give a list of promotable names for interviews/etc to Serge
- W&F Council to collaborate with Zhen Ma to develop podcasts, videos, etc to be promoted
- Serge to have discussions with USA Fencing about the role of the Diversity Officer vs Safeguarding Officer.

#### **Point 6 / Item 6 / Punto 6: Meeting with Refereeing Commission**

##### **Notes**

- Refereeing Commission expressed concern that the proposals would be too restrictive as there were not enough female referees in certain weapons.
- There was also a view that the proposals were not required as there were enough female referees and force majeure could create issues.
- There was a request to simplify the language of the proposals.

##### **Arising Actions**

- W&F Council to review proposals and suggest updates based on discussions – specifically GP & WC percentages apply across all competitions and clarification on reporting.

**Point 7 / Item 7 / Punto 7: Meeting with Medical Commission**

**Notes**

- President of Medical Commission presented on the work that had been done so far in respect to the IOC Framework on Fairness and Inclusion, noting current situation, the narrative review and laying out the options for inclusion of transgender athletes available to the FIE (see Medical Commission meeting report).

**Arising Actions**

- Working Group proposed, GU & CF-H volunteered to be part of it. Legal and Athlete representatives to be sought.



**Proposals for the 2023 Congress  
Modifications of the Organisation Rules**

The texts below are applicable on January 1st, 2024, unless mentioned otherwise.

---

**P. 1**

**Article:** **o.10**

**Proposal from:** Women and Fencing Council

**Motivation:**

Advance gender equality in Organising Committees, to assist in the development of more females in all roles in fencing and to ensure that both genders have representation.

Demonstrate the FIE's commitment to the IOC objective to advance gender equality in all aspects of Olympic sport and help ensure that the FIE meet the gender representation quotas for participation in the Olympics.

**o.10**

- 1 The Organising Committee is the group of persons responsible for organising the competition.
- 2 The Organising Committee must take note of the instructions in the Specifications ('Cahier des Charges') specific to each category of competition.
3. [The Organising Committee is expected to have representation of both genders.](#)

**Opinion of the Women and Fencing Council:**

Agreed

---

**P. 3**

**Article:** **o.16**

**Proposal from:** Women and Fencing Council

## **Motivation:**

Advance gender equality in the Directoire Technique, to assist in the development of more females in all roles in fencing and to ensure that both genders have representation.

Demonstrate the FIE's commitment to the IOC objective to advance gender equality in all aspects of Olympic sport and help ensure that the FIE are able to meet the gender representation quotas for participation in the Olympics.

## **o.16**

Nomination of the Directoire Technique

The **Directoire Technique** is composed of people **who have the experience and competence to organise competitions.**

1 *World Championships and Olympic Games.*

- a) **For the Olympic Games** the Directoire Technique is composed of **six** members of different nationalities, one of whom must represent the country where the competition is held. **There must be at least one member from each gender.**
- b) **For the World Championships**, the Directoire Technique is composed of **8** members of different nationalities, one of whom must represent the organising country. **There must be at least two members from each gender.**

2 *World Cup and Grands Prix competitions.*

The Directoire Technique is composed of three qualified persons from the country where the competition is held or invited by them. **There must be at least one member from each gender.**

3 *Veterans World Championships*

The Directoire Technique is composed of four members of different nationalities, one of whom must represent the country where the competition is held. **There must be at least one member from each gender.**

## **Opinion of the Women and Fencing Council:**

Agreed

---

**Article:** **o.18**

**Proposal from: Women and Fencing Council**

**P. 4**

## **Motivation:**

Advance gender equality in refereeing, SEMI and medical delegates, to assist in the development of more females in all roles in fencing and to ensure that both genders have representation.

Demonstrate the FIE's commitment to the IOC objective to advance gender equality in all aspects of Olympic sport and help ensure that the FIE are able to meet the gender representation quotas for participation in the Olympics.

### **o.18**

Designation of refereeing, SEMI, and medical delegates

Refereeing delegates must be members of the FIE Refereeing Commission. SEMI delegates must be members of the FIE SEMI Commission.

Medical delegates must be **a** members of the FIE Medical Commission.

#### 1. World Championships

A chief Refereeing delegate and 5 more Refereeing delegates, a chief SEMI delegate and 2 more SEMI delegates and **3** Medical delegates are appointed by the FIE Executive Committee following the recommendations of the respective commissions. **Across all the delegates there must be at least 30% of Refereeing delegates and at least one of SEMI and medical delegates from each gender.**

#### 2. Grands Prix

Two Refereeing delegates are appointed by the Executive Committee following the recommendation of the Refereeing Commission. **There must be a minimum representation of at least 20% of each gender when all Grand Prix appointments across all weapons are considered together.**

#### 3. Senior World Cup competitions

One Refereeing delegate is appointed by the Executive Committee following the recommendation of the Refereeing Commission. **There must be a minimum representation of at least 20% of each gender when all Senior World Cup appointments across all weapons are considered together.**

#### 4. Veterans World Championships

Two Refereeing delegates, one SEMI delegate and two Medical delegates are appointed by the FIE Executive Committee following the recommendations of the respective commissions. **There must be at least one delegate from each gender within the total of 5 appointments.**

## **Opinion of the Women and Fencing Council:**

---

### **o.18**

Agreed as amended:

Designation of refereeing, SEMI, and medical delegates

Refereeing delegates must be members of the FIE Refereeing Commission. SEMI delegates must be members of the FIE SEMI Commission.

Medical delegates must be **a** members of the FIE Medical Commission.

When all delegate designations are taken together (across all types of competitions and all weapons in one season) there must be a minimum of 20% representation of both genders. There must be at least one delegate of each gender from each of the Refereeing, SEMI and Medical Commissions designated at World Championships, except Veteran World Championships, where of the 5 designated delegates there must be at least one of each gender.

1. World Championships

A chief Refereeing delegate and 5 more Refereeing delegates, a chief SEMI delegate and 2 more SEMI delegates and 3 Medical delegates are appointed by the FIE Executive Committee following the recommendations of the respective commissions. ~~Across all the delegates there must be at least 30% of Refereeing delegates and at least one of SEMI and medical delegates from each gender.~~

2. Grands Prix

Two Refereeing delegates are appointed by the Executive Committee following the recommendation of the Refereeing Commission. ~~There must be a minimum representation of at least 20% of each gender when all Grand Prix appointments across all weapons are considered together.~~

3. Senior World Cup competitions

One Refereeing delegate is appointed by the Executive Committee following the recommendation of the Refereeing Commission. ~~There must be a minimum representation of at least 20% of each gender when all Senior World Cup appointments across all weapons are considered together.~~

4. Veterans World Championships

Two Refereeing delegates, one SEMI delegate and two Medical delegates are appointed by the FIE Executive Committee following the recommendations of the respective commissions. ~~There must be at least one delegate from each gender within the total of 5 appointments.~~

---

**Article:** o.25.3

P. 5

**Proposal from:** Women and Fencing Council

**Motivation:**

To assist in the FIE gaining better understanding of the numbers of female referees.

**o.25.3**

3 In addition, the organising committee of junior World Cup competitions and satellite competitions is required to monitor and report on gender diversity of the registered referees.

**Opinion of the Women and Fencing Council:**

---

Agreed as amended:

**o.25.3**

3 In addition, the FIE Supervisor or President of the Directoire Technique ~~organising committee~~ of junior World Cup competitions and satellite competitions is required to monitor and report on gender diversity of the registered referees. Reporting will be done through the FIE Supervisor's report.

---

**Article: o.26****Proposal from: Women and Fencing Council****Motivation:**

Advance gender equality in refereeing, to assist in the development of more females in all roles in fencing and to ensure that both genders have representation.

Demonstrate the FIE's commitment to the IOC objective to advance gender equality in all aspects of Olympic sport and help ensure that the FIE are able to meet the gender representation quotas for participation in the Olympics.

Where it is not possible to meet minimum expectations then written reports will assist in exploring solutions.

**o.26**

- 1 Refereeing at Veteran World Championships is carried out by referees appointed by the Executive Committee of the FIE, selected by the Refereeing Commission on indication of the Organizing Committee and Veterans Council. **There must be a minimum representation of at least 30% of each gender across all such appointments.** Referees must attend the refereeing meeting that takes place the day before the World Championships.
- 2 For **Senior World Cup, Grands Prix and World Cup team competitions**, 8 referees, proposed by the Refereeing Commission, will be designated by the Executive Committee and delegations will not have to provide any referees. **There must be a minimum of one person from each gender, if possible. If this is not possible a written explanation must be provided to the FIE.** The additional referees required (not less than 5) will be provided by the organising committee. **All the referees will be at the expense of the organisers who in return will keep the entry fees. There must be a minimum of one person from each gender, if possible. If this is not possible a written explanation must be provided to the FIE.**

**Opinion of the Women and Fencing Council:**

---

Agreed as amended:

**o.26**

- 1 Refereeing at Veteran World Championships is carried out by referees appointed by the Executive Committee of the FIE, selected by the Refereeing Commission on indication of the Organizing Committee and Veterans Council. **Either, there must be a minimum representation of at least 30% of each gender across all such appointments or the**

Refereeing Commission must provide a written explanation to the Executive Committee of the FIE.

Referees must attend the refereeing meeting that takes place the day before the World Championships.

- 2 For **Senior World Cup, Grands Prix and World Cup team competitions**, 8 referees, proposed by the Refereeing Commission, will be designated by the Executive Committee and delegations will not have to provide any referees. ~~Either there must be a minimum of one person from each gender, if possible. If this is not possible~~ or the Refereeing Commission must provide a written explanation ~~must be provided~~ to the Executive Committee of the FIE.

The additional referees required (not less than 5) will be provided by the organising committee. **All the referees will be at the expense of the organisers who in return will keep the entry fees.** ~~Either there must be a minimum of one person from each gender, if possible. or if this is not possible~~ a written explanation must be provided to the FIE in the FIE Supervisor's report.

---





**Proposals for the 2023 Congress**  
**Modifications of the Technical Rules**

**The texts below are applicable on January 1st, 2024, unless mentioned otherwise.**

---

**P.33**

**Article: t.109**

**Proposal from: Women and Fencing Council**

**Motivation:**

- 1) To clarify the expectation on all participants in a competition to respect the FIE statutes and rules, including the Ethical Code and Safeguarding Policy.
- 2) To clarify the minimum reporting expectations if people witness a breach of the Ethical Code and Safeguarding Policy.

**t.109**

Everybody taking part in or present at a fencing competition **must respect the FIE statutes and rules, including but not limited to the FIE Ethical Code and Safeguarding Policy. They must remain orderly and must not disturb the smooth running of the competition.** During bouts no one is allowed to **go near the pistes, to give advice to the fencers, to criticise the Referee** or the judges, to insult them or to attempt to influence them in any way. Even the **team captain** must remain in the space assigned to him and he may only intervene in the situations and in the manner provided for in Article t.130 of the Rules. The Referee must stop immediately any activity which disturbs the smooth running of the bout which he is refereeing (cf. t.137.1–3). Any person who, for any reason, threatens or insults an official commits an offence of the 4th group and is penalised according to article t.169.

**Any person present who witnesses a breach of the FIE Ethical Code and the Safeguarding Policy must report this to the Directoire Technique.**

**Opinion of the Women and Fencing Council:**

Agreed

---

**Article:** t.111

**Proposal from: Women and Fencing Council**

**Motivation:** To clarify that disturbing good order or smooth running can include failures to act in accordance with the FIE statutes, rules, Ethical Code and Safeguarding Policy.

**t.111**

The Referee and/or the Directoire Technique, on their own authority or at the request of an official delegate of the FIE or of the Organising Committee, can decide to expel from the competition venue, with or without a warning, any person who by his gestures, attitude, ~~or~~ language or failure to act in accordance with the FIE statutes, rules, Ethical Code and Safeguarding Policy, disturbs the good order or smooth running of the event.

**Opinion of the Women and Fencing Council:**

Agreed

---



## Proposals for the 2023 Congress

### Modifications of the Statutes

The texts below are applicable on January 1st, 2024, unless mentioned otherwise.

---

P.12

#### Article: Chapter 13

#### Proposal from: Women and Fencing Council

**Motivation:** The FIE statutes already include expectations on National Federations in relation to sport integrity for example:

***Betting and Anti Corruption: 2.5 It is recommended that Member Federations and Confederations put in place similar rules and regulations to safeguard the integrity of competitions held under their respective jurisdictions.***

The proposal is to extend Safeguarding recommendations in a similar way so that the expectations of the FIE are clear.

#### Chapter 13

(add at end):

It is recommended that Member Federations and Confederations develop and implement similar policies and procedures to safeguard and promote the welfare of all participants in fencing activity held under their respective jurisdictions.

#### **Opinion of the Women and Fencing Council:**

**Agreed**

**Article: Chapter 13**

**Proposal from: Women and Fencing Council**

**Motivation:** For the protection of all participants,

1. Extend the requirement for a Safeguarding Officer role to the Zonal Championships.
2. Ensure that unresolved safeguarding reports are reported to the FIE.

**Chapter 13**

During the Junior/Cadet and Senior and Veterans World Championships, incidents of harassment/abuse/neglect can be reported to the FIE Safeguarding Officer on site.

During Open World Cups and Junior World Cups, incidents of harassment/abuse/neglect can be reported to the FIE Supervisor, acting as the FIE Safeguarding officer. This responsibility shall be added to the list of responsibilities of Supervisors.

The FIE shall designate Safeguarding Officers to other official FIE events, for example, training camps.

The FIE shall ensure that the FIE Safeguarding Officers receive appropriate training and support for carrying out their responsibilities under this policy.

Zonal Confederations shall appoint at least one person to serve as a Safeguarding Officer at each Zonal Championship. All safeguarding reports which are not resolved through mediation must be reported to the FIE.

**Opinion of the Women and Fencing Council:**

**Agreed**

## URGENT DECISION

### PROPOSAL FROM SEMI COMMISSION

#### FIE Publicity Code, article p.12.2 a

##### Motivation:

The current formulation of the article forces sabre's fencers to make a sublimation print of the advertising logos on the sleeve of the conductive jacket. This kind of print is expensive and could be an issue for a fencer to reprint the logos each time he needs to change a jacket, for example after a malfunction/breakage or change of sponsorship. Furthermore, shortly after the jacket has been printed, the colours tend to fade and give a grey-on-grey effect which is not nice in TV shooting. The proposal therefore aims to return to the old system and allow the logos to be displayed on the upper part of the fencer's leg, as we still often see during weapons controls.

##### NEW TEXT

If a federation and/or a fencer have signed a **sponsorship contract** with a commercial or other company, the logo of that sponsorship partner may be fixed **at a rate of maximum of 3 logos, with a maximum area of 85 cm<sup>2</sup> each;**

**In foil and epee:** at the top of the sleeve of the non-sword arm of the fencing jacket; **in sabre:** at the top of the thigh of the non-sword side of the fencing breeches and clearly separated from the national logo.

---

## DECISION URGENTE

### PROPOSITION DE LA COMMISSION SEMI

#### Code de la publicité de la FIE, article p.12.2 a

##### Motivation :

La formulation actuelle de l'article oblige les sabreurs à imprimer par sublimation les logos publicitaires sur la manche de la veste conductrice. Ce type d'impression est coûteux et pourrait poser problème à un escrimeur qui devrait réimprimer les logos chaque fois qu'il doit changer de veste, par exemple après un dysfonctionnement/une casse ou un changement de parrainage. En outre, peu après l'impression de la veste, les couleurs ont tendance à s'estomper et à donner un effet gris sur gris, ce qui n'est pas agréable pour les tournages télévisés. La proposition vise donc à revenir à l'ancien système et à autoriser l'affichage des logos sur la partie supérieure de la jambe du tireur, comme on le voit encore souvent lors des contrôles des armes.

##### NOUVEAU TEXTE

Si la Fédération ou/et le tireur a/ont signé un **contrat de partenariat** avec une société commerciale ou autre, un logo pourra être apposé **à raison de 3 logos au maximum d'une dimension maximale de 85 cm<sup>2</sup> chacun ;**  
**Au fleuret et à l'épée :** sur le haut de la manche de la veste d'escrime (bras non armé);  
**au sabre :** sur le pantalon en haut de la cuisse (côté non armé) et clairement séparé du logo national.

---

**DECISION URGENTE**  
**PROPUESTA DE LA COMISIÓN SEMI**

**Código de la publicidad de la FIE, artículo p.12.2 a**

**Motivación:**

La formulación actual del artículo obliga a los esgrimistas de sable a realizar una impresión por sublimación de los logotipos publicitarios en la manga de la chaqueta conductora. Este tipo de impresión es caro y podría ser un problema para un esgrimista volver a imprimir los logotipos cada vez que necesite cambiar de chaqueta, por ejemplo después de una avería/rotura o cambio de patrocinador. Además, poco después de la impresión de la chaqueta, los colores tienden a desteñirse y dan un efecto gris sobre gris que no es agradable en las tomas de televisión. Por lo tanto, la propuesta pretende volver al antiguo sistema y permitir que los logotipos se muestren en la parte superior de la pierna del esgrimista, como todavía vemos a menudo durante los controles de armas.

**NUEVO TEXTO**

Si la Federación y/o el esgrimista firmó un **contrato de patrocinio** con una sociedad comercial u otra, un logotipo podrá ser colocado **a razón de 3 logotipos como máximo, cada uno con un tamaño máximo de 85 cm<sup>2</sup> ;**

**En florete y espada:** en la parte superior de la manga de la chaqueta de esgrima (brazo no armado);

**en sable:** en el pantalón, en la parte superior del muslo (lado no armado) y claramente separado del logotipo nacional.

## Urgent decisions of the Executive Committee

### Technical rules

#### General rules and rules common to the three weapons

##### t.1 Definition of the fencer's salute

In competition, the fencer's salute is a gesture of civility towards the opponent, the referee and the spectators.

To perform the fencer's salute, the two fencers:

- face each other
- stand still on their on-guard line
- place the mask under the non-sword arm
- lift the guard to the chin
- then lower the blade to the ground

##### t.122, Rule until the end of the 2023-2024 season

Before the beginning and at the end of a bout, the two fencers must perform the **fencer's salute** to their opponent, to the referee and to the spectators, as defined in article t.1.

When the final hit of the bout has been scored, the two fencers stand still on their on-guard line while the referee is making his/her decision.

The two fencers then perform the **fencer's salute** (cf. t.1) to their opponent, to the referee and to the spectators.

The bout has then ended.

~~Before the beginning of each bout, the two fencers must perform a **fencer's salute** to their opponent, to the Referee and to the spectators. Equally, when the final hit has been scored, the bout has not ended until the two fencers have saluted each other, the Referee and the spectators: to this end, they must remain still while the referee is making his decision; when he has given his decision, they must **return to their on-guard line**, perform a fencer's salute and shake **hands** with their opponent.~~

If either or both of the two fencers refuse to comply with these rules, the Referee will penalise him/**her**/them as specified for offences of the 4th group (cf. t.158-162, t.169, t.170).

## FIE FENCING AND ENVIRONMENT WORKING GROUP ACTIVITY REPORT 2023

<b>Meetings</b>	<b>On line meetings:</b> 1. 19.04.2023 2.
<b>Participants:</b> <b>Participants:</b> <b>Participantes:</b>	1. Ana Irene Delgado Guerra, FIE Vice-President, Head of the working group 2. Clare Halsted, European Fencing Confederation 3. Marcelo Lorca, Pan-American Fencing Confederation 4. Matthew Baker, Oceania Fencing Confederation 5. Baiba Brandule, FIE SEMI Commission 6. Reni Hamzulida, Asian Fencing Confederation, 7. Abdoul Wahab Zorome, African Fencing Confederation 8. Maha Mourad, FIE Medical Commission 9. Joyce Bolanos, FIE PCM Commission
<b>Consultation</b>	Besides the on-line meetings, the WG is active on permanent basis by e-mail and WhatsApp

### ACTIVITY REPORT

#### **Point 1 / Item1 / Punto 1: FIE ENVIRONMENTAL POLICY**

Dr Halsted and Dr Mourad drafted the FIE Environmental Policy, with the cooperation of IOC.

The text was approved by the Working Group and submitted to the Executive Committee for approval on the 26<sup>th</sup> of May.

The FIE Environmental Policy has been approved and embedded in the FIE Administrative Rules.

Action plan to be studied to implement the policy for 2024.

#### **Point 2 / Item2 / Punto 2: WEBINAR ORGANIZED BY FIE WITH IOC PARTICIPATION**

The project of a webinar for NFs about sustainability and environmental protection took place on June 8th, 2023- 13.00-15.00 CEST Time

Panelists:

- Ana Irene Delgado Guerra, FIE Vice-President, Head of the Working Group “Fencing and Environment”
- Julie Duffus, IOC, Sustainability Senior Manager
- Melissa Alvarenga, Panamerican Fencing Confederation, Executive Secretary
- Alaaeldin Abouelkassem (EGY), Olympic Medalist
- Bianca Santa Athlete (PUR), fencer



- Carlos Correa Former Environment Minister of Colombia
- Alvaro de Marichalar Explorer (ESP)
- Etienne Stott Olympic medalist (GBR)

Moderator: Serge Timacheff

Simultaneous translation was provided in English, Spanish and French.

### **Point 3 / Item 3 / Punto 3: ATHLETES AMBASSADORS**

2) The process to select athletes ambassadors from all the zones must be defined.

It is suggested to let open the number of athletes that want to be ambassadors for “Fencing and Environment”, so that all the zones and all the areas of interest can be covered.

Athletes ambassadors may be mainly employed in awareness raising programs and activities on social media. Possibility to award a diploma to recognize the commitment of the involved athletes, similar to DYFG diploma or diploma for nominees of the Fair Play trophy that do not receive the final award.

However, some athletes showed particular sensitivity and can be considered to be officially proposed the role: Bianca Santa (PUR) is extremely active in Puerto Rico on raising awareness on environmental issues. Sanojah Gilkes athlete participated in the tree planting ceremony in Plovdiv.

### **Point 4 / Item 4 / Punto 4: JUNIOR AND CADETS WORLD CHAMPIONSHIPS IN PLOVDIV**

The first edition of the Fencing for the Planet Day was celebrated in Plovdiv.

An official ceremony of tree planting took place with the Major and the Members of the Executive Committee



Video were shown during the competition, with the team animation.

Overall, the social media feedback for the Fencing for the planet day consisted of 83k viewership and 2.2 k engagement.

### **Point 5 / Item 5 / Punto 5: LIST OF ACTIONS TO PROPOSE TO FIE MEMBERS**

Two surveys were launched in autumn 2022, to assess the general degree of commitment and awareness of the fencing family.

One survey was addressed to all the NFs.

One survey was addressed to all the FIE Members of Commissions, councils and committees.

Results are attached.

#### **Point 6 / Item 6 / Punto 6: MILAN WORLD CHAMPIONSHIPS**

A roll-up dedicated to Fencing For the Planet and the video with the theme animation were displayed in Milano.

#### **Point 7 / Item 7 / Punto 7: RESEARCH FOR PARTNERSHIP TO START EVALUATING CARBON FOOTPRINT OF FIE AND FENCING COMPETITION.**

Preliminary informal discussions to explore the feasibility of a partnership were held with external partners providing environmental services:

- The Shift.
- Sporting Giants.

Offers were received for comparison and analysis.

Informal discussions were also held with the following IFs, to inquire about good practices and strategies.

- FEI
- UWW
- UCI

#### **Point 8 / Item 8 / Punto 8: WORKING PLAN FOR 2023**

1) WEBINAR 2 FOR NFs and competition organisers. Proposed date: mid-December.  
Panel and program still TBD.

2) DYFG program at zonal level

The DYFG program should be replicated also at continental level. This would allow to benefit those countries that do not apply for the program because they do not attend the world championships. The administrative part for the application and the legal framework should be run by the Confederation. As a SEMI Delegate is always present at the zonal championships, to check the donated equipment would be feasible. However, Baiba Brandule observed that the SEMI delegate allocated for the competition would not necessarily have enough time for extra work.

Project to be discussed with Confederations.

3) Guidelines for Competition organisers.

Matthew Baker (NZL) from the Working Group, has drafted a series of guidelines to reduce environmental impact of competition organisations.

4) Communication plan

It is necessary to coordinate with CMTV department and in particular with the Digital Communication Manager, so that all the actions of the Working Group, but also the initiatives of NFs, athletes and clubs enjoy the right visibility.

## FIE sustainability survey - part 1

### General positioning, education, awareness

#### A) Abstract from the survey:

With the present survey, the FIE is consulting all its National Federations to assess the level of the commitment of the fencing family in sustainability and environmental protection and plan targeted actions for the future.

The survey consists of 3 parts:

- **Part 1: general positioning, education, awareness**

- Part 2: office activities

- Part 3: competitions and events

#### B) Summary of the questions:

1. Please, let us know your general positioning concerning sustainability and environmental protection:
2. Do you have a clear environmental policy in your official documents?
3. Do you publicise your environmental requests to all attendees in advance?
4. Do you have posters at the event (reusable) to reinforce your request?
5. Do you have athlete ambassadors for the environment?
6. Do you have a specific focus you are committed to?

#### Consideration:

**40** people participated in the first part of the survey.

---

Q1



Personnaliser

Enregistrer sous ▼

Please, let us know your general positioning concerning sustainability and environmental protection:

Réponse(s) obtenue(s) : 40 Question(s) ignorée(s) : 0

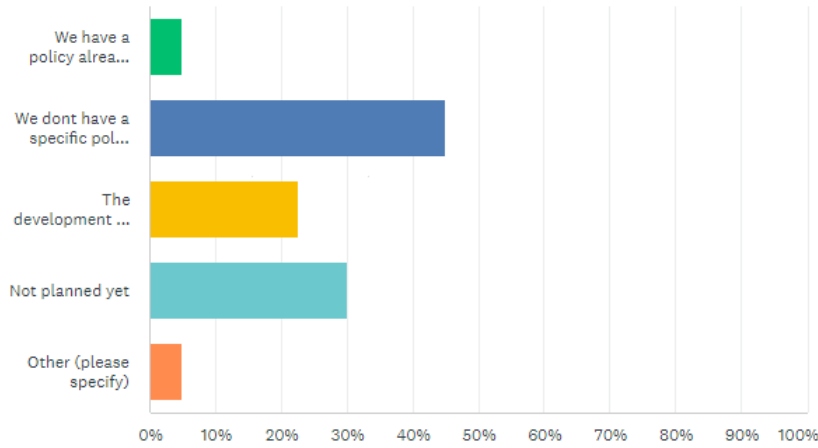

CHOIX DE RÉPONSES	RÉPONSES
▼ We have a policy already in place and actions implemented	5,00 % 2
▼ We dont have a specific policy but we do undertake some concrete actions	45,00 % 18
▼ The development of a policy and actions to implement is under consideration	22,50 % 9
▼ Not planned yet	30,00 % 12
▼ Other (please specify)	Réponses 5,00 % 2
Nombre total de participants : 40	

Q2



Personnaliser

Enregistrer sous ▼

Do you have a clear environmental policy in your official documents?

Réponse(s) obtenue(s) : 40 Question(s) ignorée(s) : 0

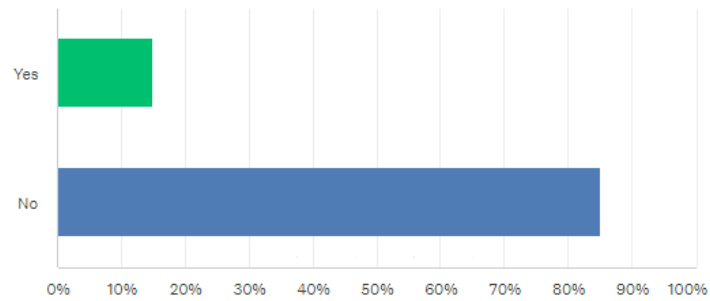

CHOIX DE RÉPONSES	RÉPONSES	
▼ Yes	15,00 %	6
▼ No	85,00 %	34
<b>TOTAL</b>		<b>40</b>

Q3



Personnaliser

Enregistrer sous ▼

Do you publicise your environmental requests to all attendees in advance?

Réponse(s) obtenue(s) : 40 Question(s) ignorée(s) : 0

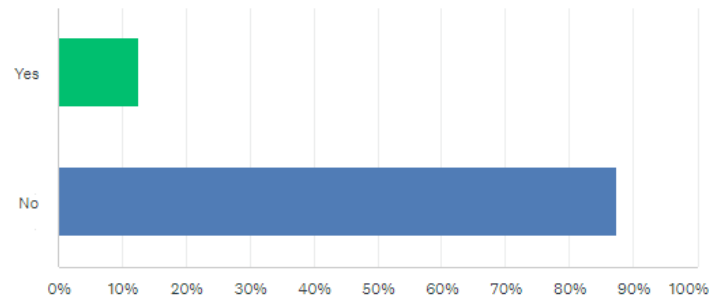

CHOIX DE RÉPONSES	RÉPONSES
▼ Yes	12,50 % 5
▼ No	87,50 % 35
<b>TOTAL</b>	<b>40</b>

Q4



Personnaliser

Enregistrer sous ▾

Do you have posters at the event (reusable) to reinforce your request?

Réponse(s) obtenue(s) : 40 Question(s) ignorée(s) : 0

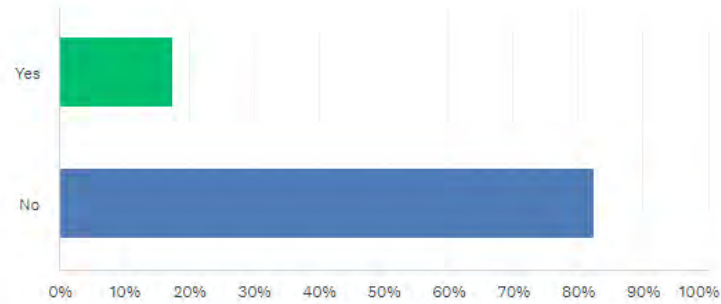

CHOIX DE RÉPONSES	RÉPONSES	
▾ Yes	17,50 %	7
▾ No	82,50 %	33
<b>TOTAL</b>		<b>40</b>



Q5



Personnaliser

Enregistrer sous ▼

## Do you have athlete ambassadors for the environment?

Réponse(s) obtenue(s) : 40 Question(s) ignorée(s) : 0

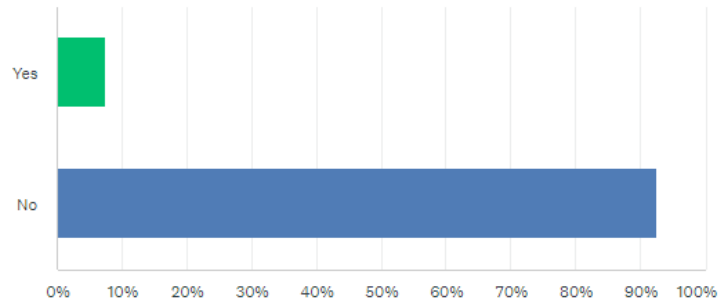

CHOIX DE RÉPONSES ▼	RÉPONSES ▼
▼ Yes	7,50 % 3
▼ No	92,50 % 37
<b>TOTAL</b>	<b>40</b>

Q6



Personnaliser

Enregistrer sous ▼

## Do you have a specific focus you are committed to?

Réponse(s) obtenue(s) : 40 Question(s) ignorée(s) : 0

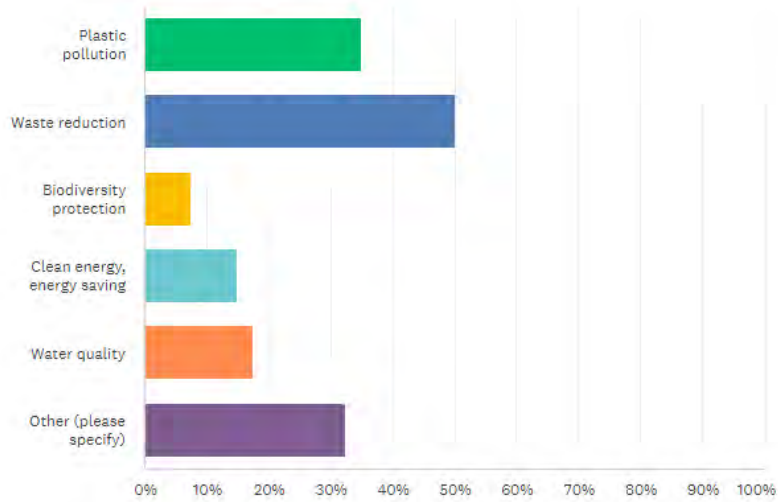

CHOIX DE RÉPONSES	RÉPONSES	
▼ Plastic pollution	35,00 %	14
▼ Waste reduction	50,00 %	20
▼ Biodiversity protection	7,50 %	3
▼ Clean energy, energy saving	15,00 %	6
▼ Water quality	17,50 %	7
▼ Other (please specify)	Réponses 32,50 %	13
Nombre total de participants : 40		

## FIE sustainability survey - part 2

### Competitions and events.

#### A) Abstract from the survey:

With the present survey, the FIE is consulting all its National Federations to assess the level of the commitment of the fencing family in sustainability and environmental protection and plan targeted actions for the future.

The survey consists of 3 parts:

- Part 1: general positioning, education, awareness

- **Part 2: office activities**

- Part 3: competitions and events

#### B) Summary of the questions:

1. Office activities: energy costs of premises. Sources of energy.
2. Office activities: energy costs of premises. Energy use reduction.
3. Office activities: staff daily commuting. Ways of transportation.
4. Office activities: staff travel. Subsidies for ecological solutions.
5. Office activities: staff travel. Other measures.
6. Office activities: meetings.
7. Office activities. Waste and recycling. Plastic policy.
8. Office activities. Waste and recycling. Use of paper.
9. Office activities. Waste and recycling. Garbage separation and recycling.

Office activities. Cleaning materials.

#### Consideration:

The maximum number of people answering the questions is **38**.

One question only has 37 feedbacks.

Q1



Personnaliser

Enregistrer sous ▼

## Office activities: energy costs of premises. Energy is:

Réponse(s) obtenue(s) : 38 Question(s) ignorée(s) : 0

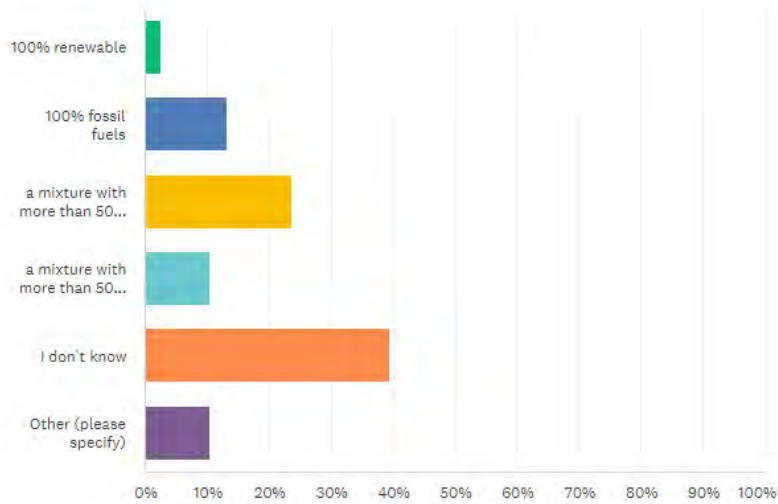

CHOIX DE RÉPONSES	RÉPONSES
▼ 100% renewable	2,63 % 1
▼ 100% fossil fuels	13,16 % 5
▼ a mixture with more than 50% renewable	23,68 % 9
▼ a mixture with more than 50% fossil fuels	10,53 % 4
▼ I don't know	39,47 % 15
▼ Other (please specify)	Réponses 10,53 % 4
<b>TOTAL</b>	<b>38</b>

Q2



Personnaliser

Enregistrer sous ▼

## Office activities: energy costs of premises. Energy use is reduced by:

Réponse(s) obtenue(s) : 38 Question(s) ignorée(s) : 0

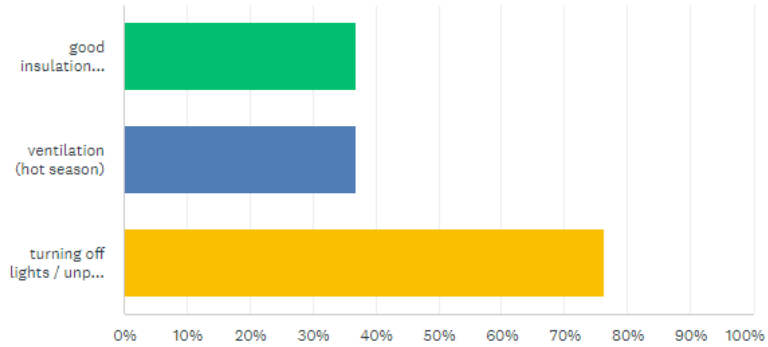

CHOIX DE RÉPONSES ▼

RÉPONSES ▼

▼ good insulation (cold season)

36,84 %

14

▼ ventilation (hot season)

36,84 %

14

▼ turning off lights / unplug electrical devices

76,32 %

29

Nombre total de participants : 38

Q3



Personnaliser

Enregistrer sous ▼

Office activities: staff travel. To go to work the staff uses:

Réponse(s) obtenue(s) : 38 Question(s) Ignorée(s) : 0

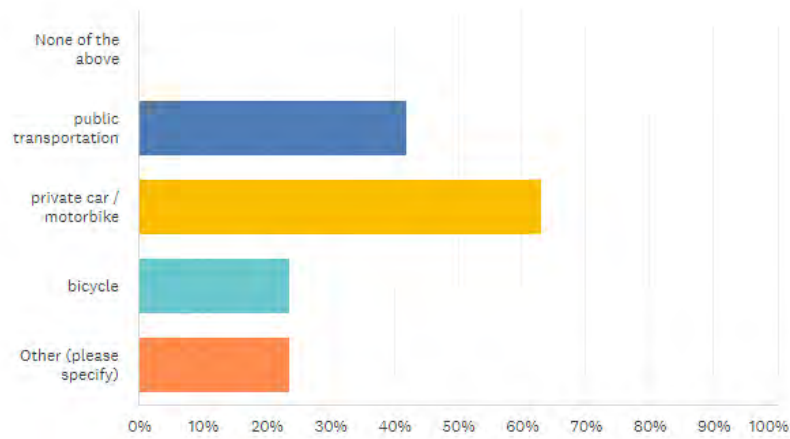

CHOIX DE RÉPONSES	RÉPONSES	
▼ None of the above	0,00 %	0
▼ public transportation	42,11 %	16
▼ private car / motorbike	63,16 %	24
▼ bicycle	23,68 %	9
▼ Other (please specify)	Réponses 23,68 %	9
Nombre total de participants : 38		

Q4



Personnaliser

Enregistrer sous ▼

## Office activities: staff travel. Do you subsidise or encourage:

Réponse(s) obtenue(s) : 38 Question(s) ignorée(s) : 0

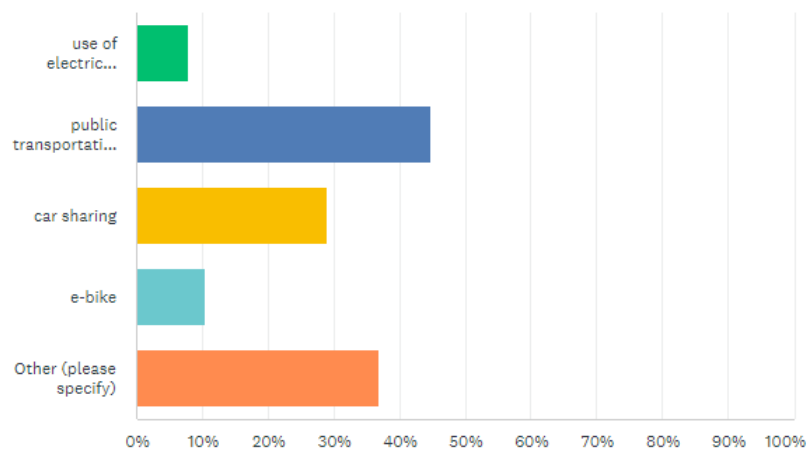

CHOIX DE RÉPONSES	RÉPONSES
▼ use of electric vehicles	7,89 % 3
▼ public transportation subscriptions	44,74 % 17
▼ car sharing	28,95 % 11
▼ e-bike	10,53 % 4
▼ Other (please specify)	Réponses 36,84 % 14
Nombre total de participants : 38	

Q5



Personnaliser

Enregistrer sous ▼

Office activities: staff travel. Other measures. Do you have / implement:

Réponse(s) obtenue(s) : 38 Question(s) ignorée(s) : 0

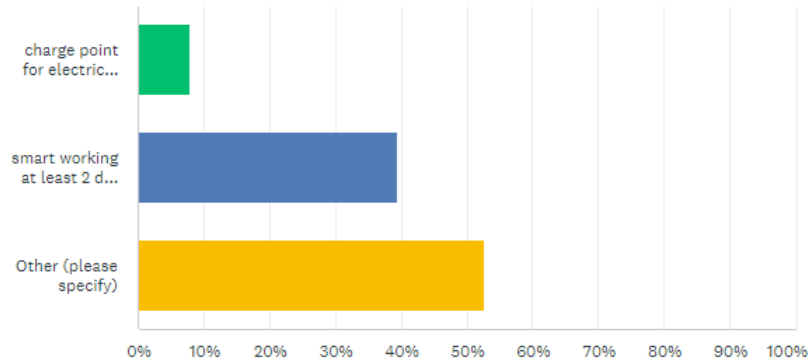

CHOIX DE RÉPONSES	RÉPONSES
▼ charge point for electric vehicles	7,89 % 3
▼ smart working at least 2 days per week	39,47 % 15
▼ Other (please specify) <span style="float: right;">Réponses</span>	52,63 % 20
Nombre total de participants : 38	





## Office activities: meetings. Meetings are

Réponse(s) obtenue(s) : 38 Question(s) ignorée(s) : 0

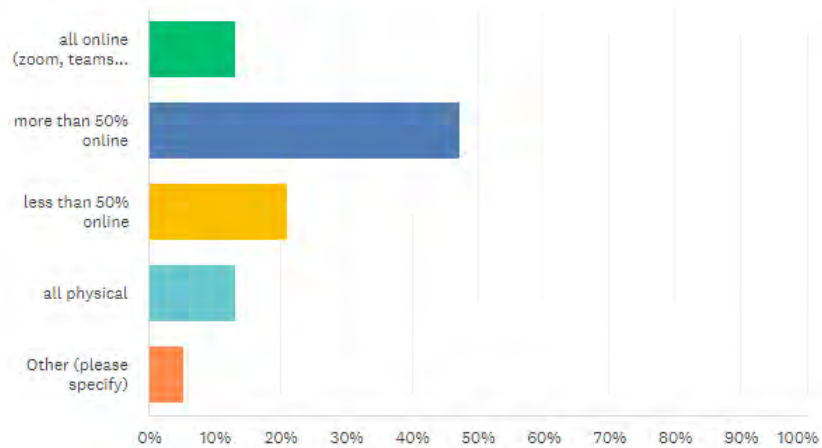

CHOIX DE RÉPONSES	RÉPONSES	RÉPONSES
▼ all online (zoom, teams, other...)	13,16 %	5
▼ more than 50% online	47,37 %	18
▼ less than 50% online	21,05 %	8
▼ all physical	13,16 %	5
▼ Other (please specify)	Réponses 5,26 %	2
<b>TOTAL</b>		<b>38</b>

Q7



Personnaliser

Enregistrer sous ▼

Office activities. Waste and recycling. Plastic policy. Plastic rubbish is reduced by:

Réponse(s) obtenue(s) : 38 Question(s) ignorée(s) : 0

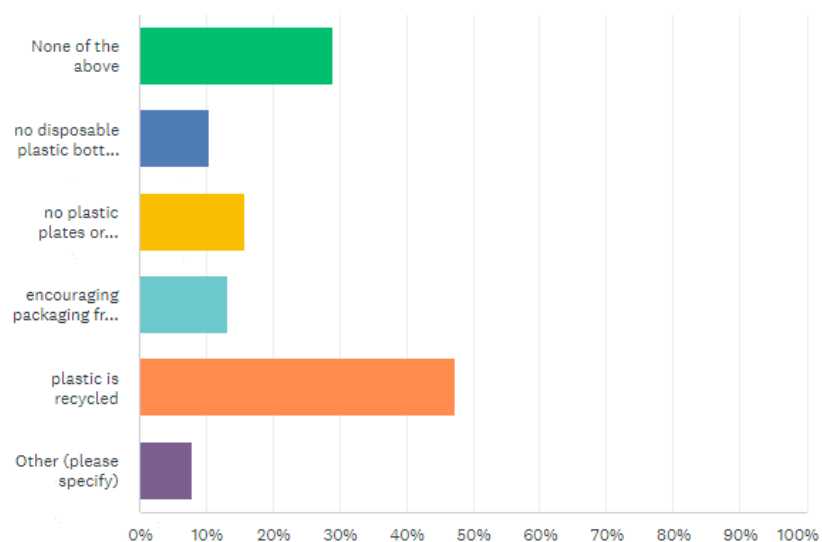

CHOIX DE RÉPONSES	RÉPONSES
▼ None of the above	28,95 % 11
▼ no disposable plastic bottles or cups allowed	10,53 % 4
▼ no plastic plates or cutlery	15,79 % 6
▼ encouraging packaging free purchases	13,16 % 5
▼ plastic is recycled	47,37 % 18
▼ Other (please specify)	Réponses 7,89 % 3
Nombre total de participants : 38	

Q8



Personnaliser

Enregistrer sous ▾

## Office activities. Waste and recycling. Use of paper is:

Réponse(s) obtenue(s) : 38 Question(s) ignorée(s) : 0

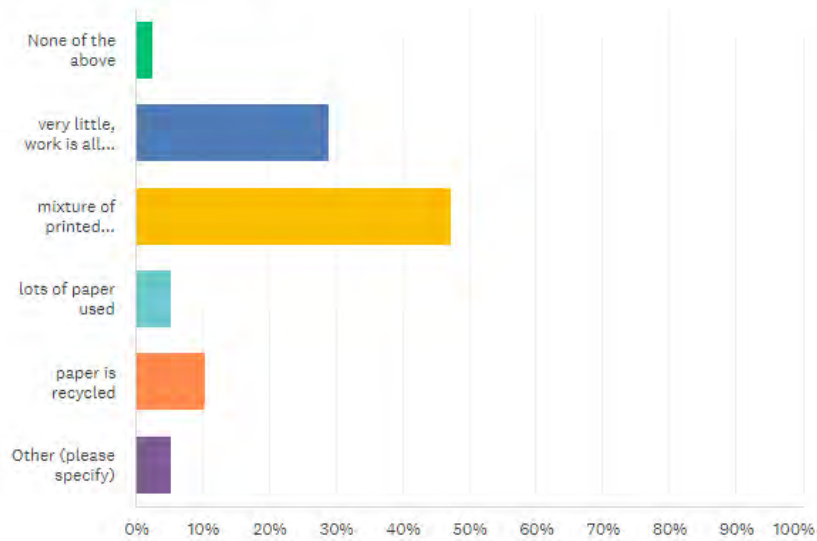

CHOIX DE RÉPONSES	RÉPONSES	
▼ None of the above	2,63 %	1
▼ very little, work is all digitalised	28,95 %	11
▼ mixture of printed material and digital	47,37 %	18
▼ lots of paper used	5,26 %	2
▼ paper is recycled	10,53 %	4
▼ Other (please specify)	<a href="#">Réponses</a> 5,26 %	2
<b>TOTAL</b>		<b>38</b>

Q9



Personnaliser

Enregistrer sous ▼

## Office activities. Waste and recycling. Garbage separation and recycling concerns:

Réponse(s) obtenue(s) : 37 Question(s) ignorée(s) : 1

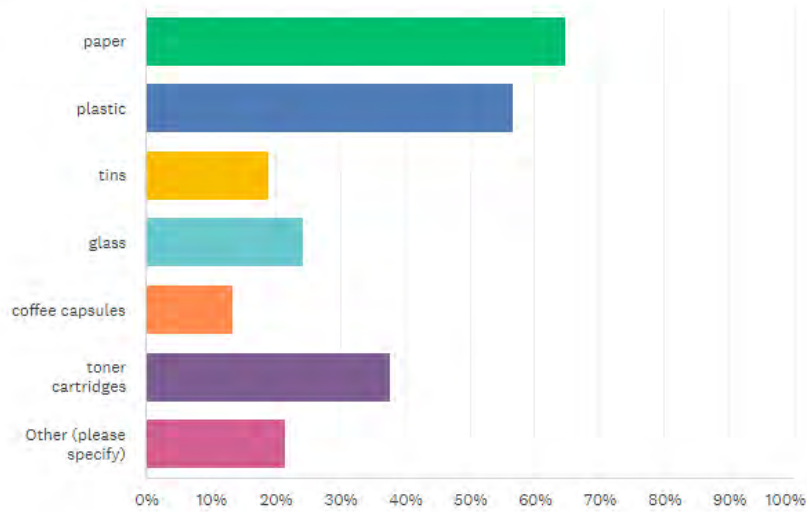

CHOIX DE RÉPONSES	RÉPONSES	
▼ paper	64,86 %	24
▼ plastic	56,76 %	21
▼ tins	18,92 %	7
▼ glass	24,32 %	9
▼ coffee capsules	13,51 %	5
▼ toner cartridges	37,84 %	14
▼ Other (please specify)	Réponses 21,62 %	8
Nombre total de participants : 37		

Q10



Personnaliser

Enregistrer sous

## Office activities. Cleaning materials employed are:

Réponse(s) obtenue(s) : 37 Question(s) ignorée(s) : 1

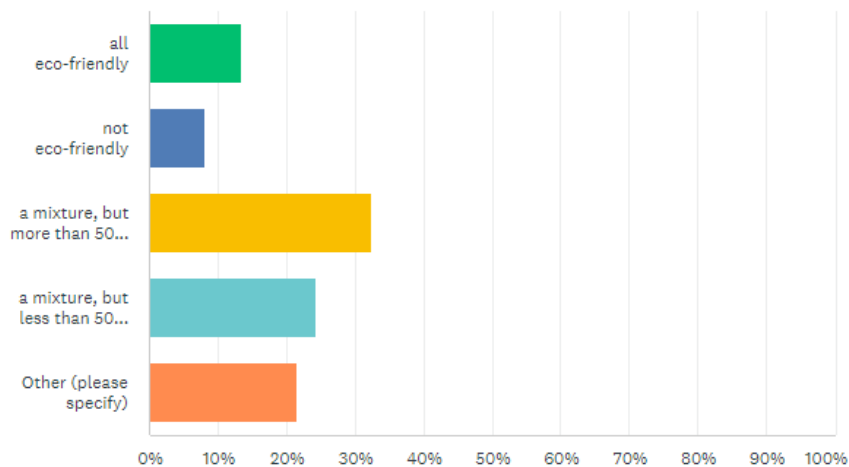

CHOIX DE RÉPONSES	RÉPONSES
▼ all eco-friendly	13,51 % 5
▼ not eco-friendly	8,11 % 3
▼ a mixture, but more than 50% eco-friendly	32,43 % 12
▼ a mixture, but less than 50% eco-friendly	24,32 % 9
▼ Other (please specify) <a href="#">Réponses</a>	21,62 % 8
<b>TOTAL</b>	<b>37</b>

## FIE sustainability survey - part 3

### Competitions and events.

#### A) Abstract from the survey:

With the present survey, the FIE is consulting all its National Federations to assess the level of the commitment of the fencing family in sustainability and environmental protection and plan targeted actions for the future.

The survey consists of 3 parts:

- Part 1: general positioning, education, awareness

- Part 2: office activities

**- Part 3: competitions and events**

#### B) Summary of the questions:

1. Competitions and events. Energy costs of venue. Source of energy.
2. Competitions and events. Energy costs of venue. Energy use reduction.
3. Competitions and events: Officials travel (eg to go to national events). Ways of transportation.
4. Competition and events. Choice of venue. Selection criteria.
5. Competitions and events. Travel plans for participants.
6. Competitions and events. Waste reduction. Plastic policy.
7. Competitions and events. Waste reduction. Waste recycling.
8. Competitions and events. Fencing material. Do you have a scheme to re-use second-hand fencing kit?
9. Competitions and events. Catering and food waste.
10. Competitions and events. Drinking water.

#### Consideration:

The maximum number of people answering the questions is **38**.

Some questions have only 31, 34 or 37 feedbacks.

That implies that some questions of the present survey were not answered.

Q1



Personnaliser

Enregistrer sous ▼

## Competitions and events: energy costs of venue. Energy is:

Réponse(s) obtenue(s) : 38 Question(s) ignorée(s) : 0

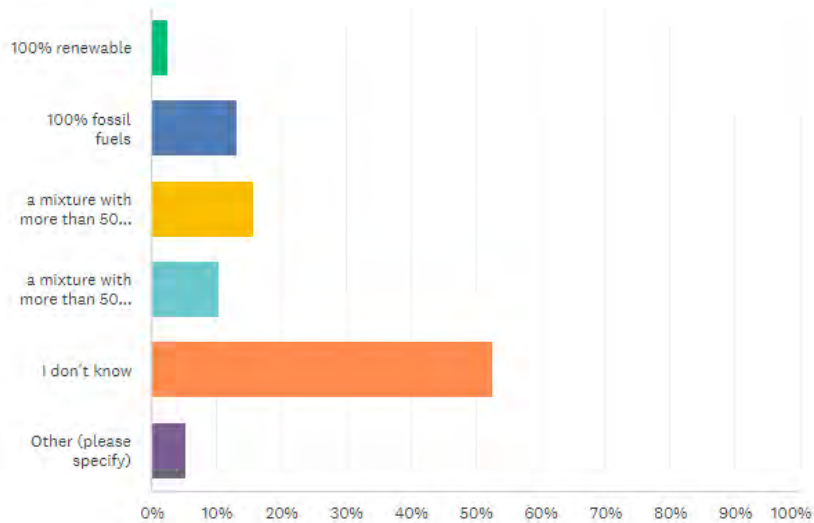

CHOIX DE RÉPONSES	RÉPONSES	
▼ 100% renewable	2,63 %	1
▼ 100% fossil fuels	13,16 %	5
▼ a mixture with more than 50% renewable	15,79 %	6
▼ a mixture with more than 50% fossil fuels	10,53 %	4
▼ I don't know	52,63 %	20
▼ Other (please specify)	Réponses 5,26 %	2
<b>TOTAL</b>		<b>38</b>

Q2



Personnaliser

Enregistrer sous ▼

## Competitions and events: energy costs of venue. Energy use is reduced by:

Réponse(s) obtenue(s) : 38 Question(s) ignorée(s) : 0

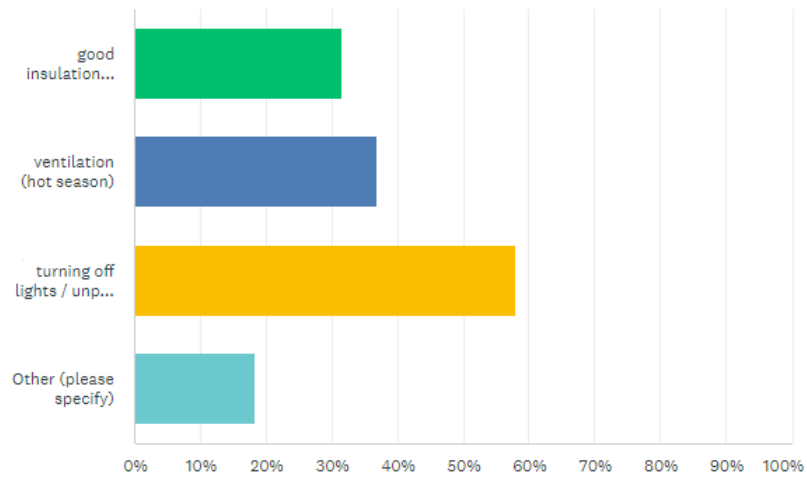

CHOIX DE RÉPONSES	RÉPONSES
▼ good insulation (cold season)	31,58 % 12
▼ ventilation (hot season)	36,84 % 14
▼ turning off lights / unplug electrical devices	57,89 % 22
▼ Other (please specify) <a href="#">Réponses</a>	18,42 % 7
Nombre total de participants : 38	



Q3



Personnaliser

Enregistrer sous ▼

## Competitions and events: Officials travel (eg to go to national events):

Réponse(s) obtenue(s) : 38 Question(s) ignorée(s) : 0

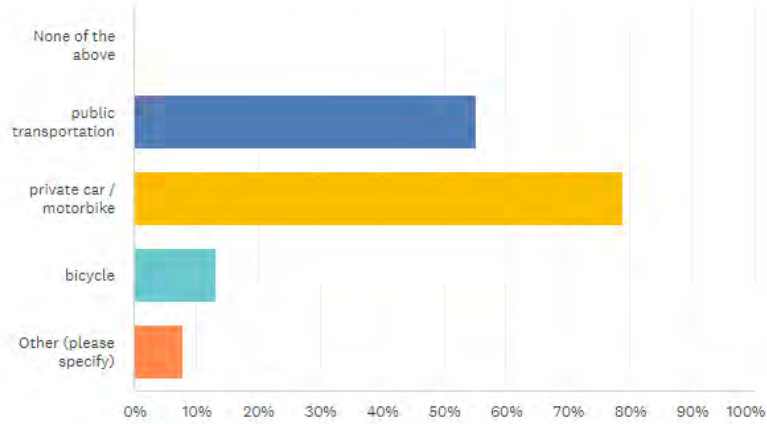

CHOIX DE RÉPONSES	RÉPONSES	
▼ None of the above	0,00 %	0
▼ public transportation	55,26 %	21
▼ private car / motorbike	78,95 %	30
▼ bicycle	13,16 %	5
▼ Other (please specify)	Réponses 7,89 %	3
Nombre total de participants : 38		

Q4

Personnaliser Enregistrer sous

Competition and events. Choice of venue. We look at the location in relation to:

Réponse(s) obtenue(s) : 38 Question(s) ignorée(s) : 0

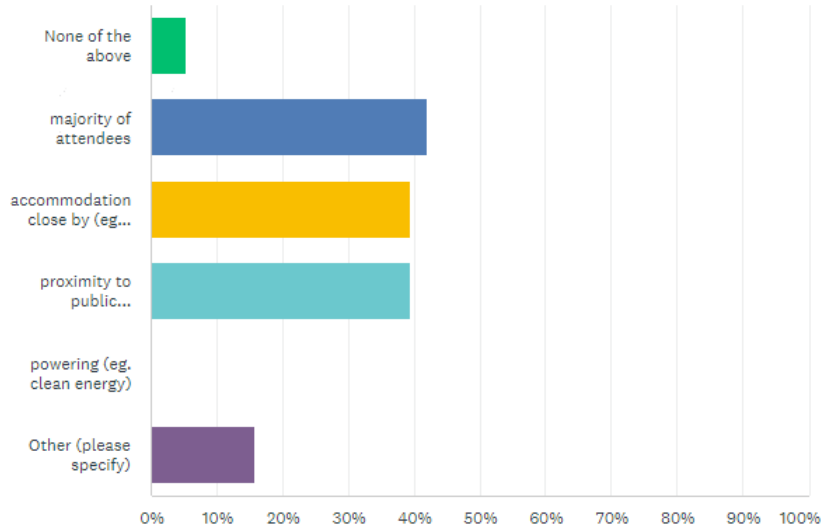

CHOIX DE RÉPONSES	RÉPONSES
None of the above	5,26 % 2
majority of attendees	42,11 % 16
accommodation close by (eg in a walking distance)	39,47 % 15
proximity to public transportation	39,47 % 15
powering (eg. clean energy)	0,00 % 0
Other (please specify)	Réponses 15,79 % 6
Nombre total de participants : 38	

Q5



Personnaliser

Enregistrer sous ▼

## Competitions and events. Travel plans. The majority of participants uses:

Réponse(s) obtenue(s) : 38 Question(s) ignorée(s) : 0

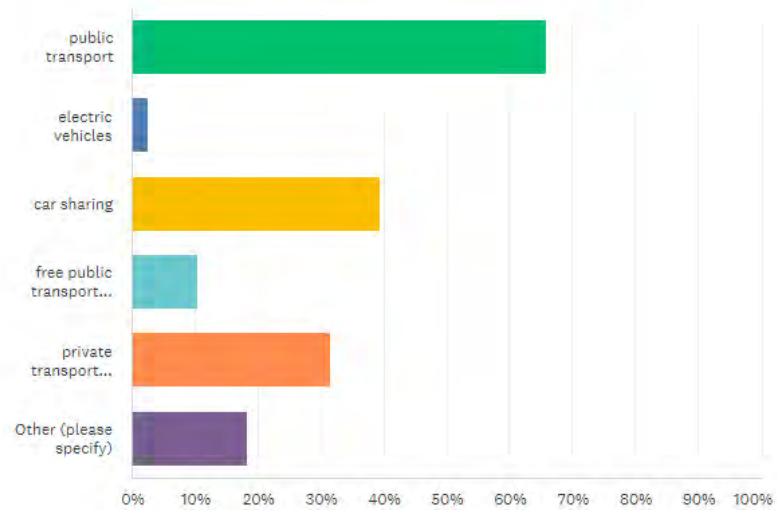

CHOIX DE RÉPONSES	RÉPONSES	
▼ public transport	65,79 %	25
▼ electric vehicles	2,63 %	1
▼ car sharing	39,47 %	15
▼ free public transport provided to accredited people	10,53 %	4
▼ private transport organised by LOC	31,58 %	12
▼ Other (please specify)	Réponses 18,42 %	7
<b>Nombre total de participants : 38</b>		



## Competitions and events. Waste reduction. Plastic policy:

Réponse(s) obtenue(s) : 31 Question(s) ignorée(s) : 7

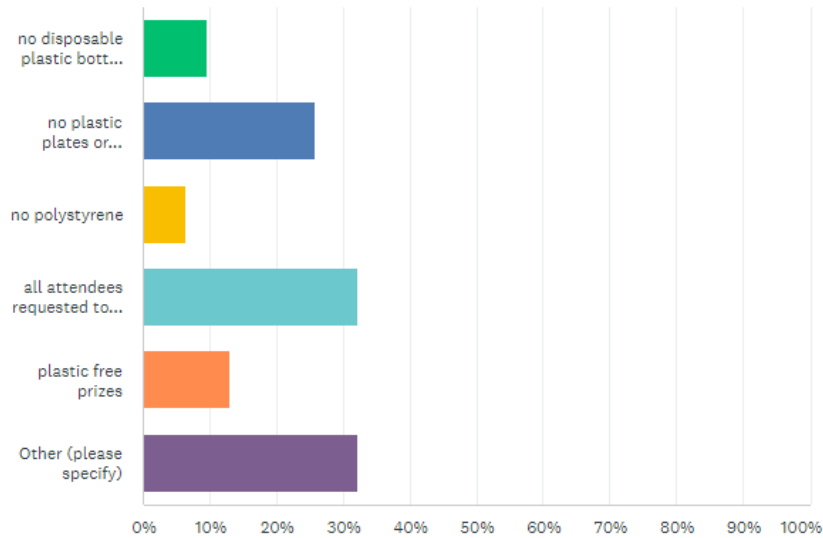

CHOIX DE RÉPONSES	RÉPONSES	
▼ no disposable plastic bottles or cups allowed	9,68 %	3
▼ no plastic plates or cutlery provided	25,81 %	8
▼ no polystyrene	6,45 %	2
▼ all attendees requested to bring their reusable bottle	32,26 %	10
▼ plastic free prizes	12,90 %	4
▼ Other (please specify)	Réponses 32,26 %	10
<b>Nombre total de participants : 31</b>		

Q7



Personnaliser

Enregistrer sous ▼

## Competitions and events. Waste reduction. Waste recycling:

Réponse(s) obtenue(s) : 37 Question(s) ignorée(s) : 1

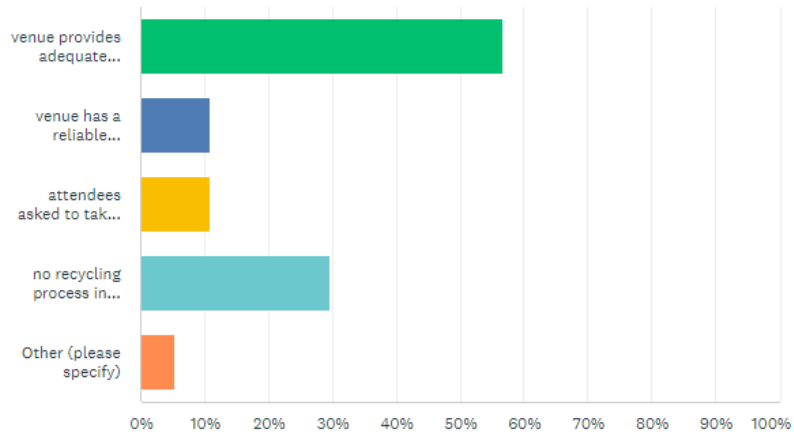

CHOIX DE RÉPONSES	RÉPONSES
▼ venue provides adequate recycling bins to separate garbage, linked to the municipality service	56,76 % 21
▼ venue has a reliable recycling process	10,81 % 4
▼ attendees asked to take own recycling away with them	10,81 % 4
▼ no recycling process in place	29,73 % 11
▼ Other (please specify)	Réponses 5,41 % 2

Nombre total de participants : 37

Q8



Personnaliser

Enregistrer sous ▼

Competitions and events. Fencing material. Do you have a scheme to re-use second-hand fencing kit?

Réponse(s) obtenue(s) : 38 Question(s) ignorée(s) : 0

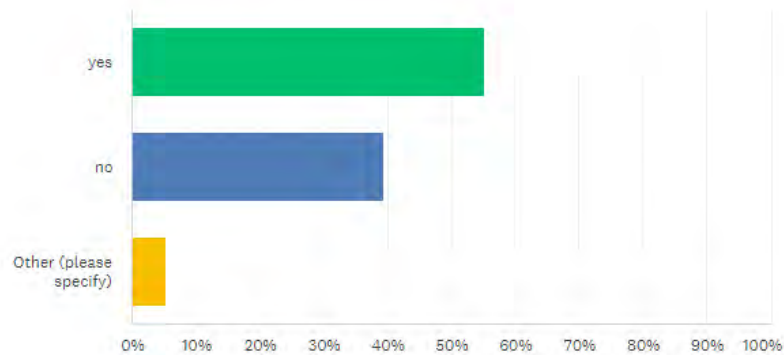

CHOIX DE RÉPONSES	RÉPONSES	
▼ yes	55,26 %	21
▼ no	39,47 %	15
▼ Other (please specify)	Réponses 5,26 %	2
<b>TOTAL</b>		<b>38</b>



Competitions and events. Catering and food waste. The following actions are implemented:

Réponse(s) obtenue(s) : 34 Question(s) ignorée(s) : 4

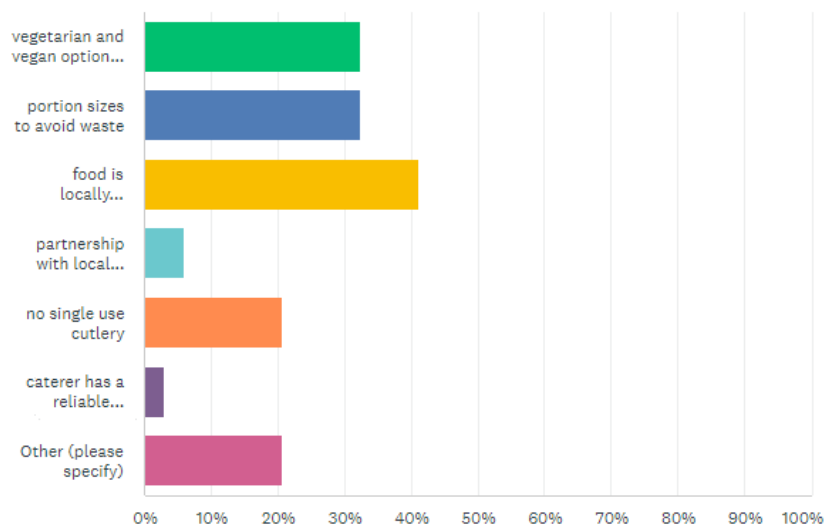

CHOIX DE RÉPONSES	RÉPONSES	
▼ vegetarian and vegan options available	32,35 %	11
▼ portion sizes to avoid waste	32,35 %	11
▼ food is locally produced (at least more than 50%)	41,18 %	14
▼ partnership with local charities and initiatives to distribute unsold food	5,88 %	2
▼ no single use cutlery	20,59 %	7
▼ caterer has a reliable recycling process	2,94 %	1
▼ Other (please specify)	Réponses 20,59 %	7
Nombre total de participants : 34		

Q10



Personnaliser

Enregistrer sous ▾

## Competitions and events. Drinking water:

Réponse(s) obtenue(s) : 38 Question(s) ignorée(s) : 0

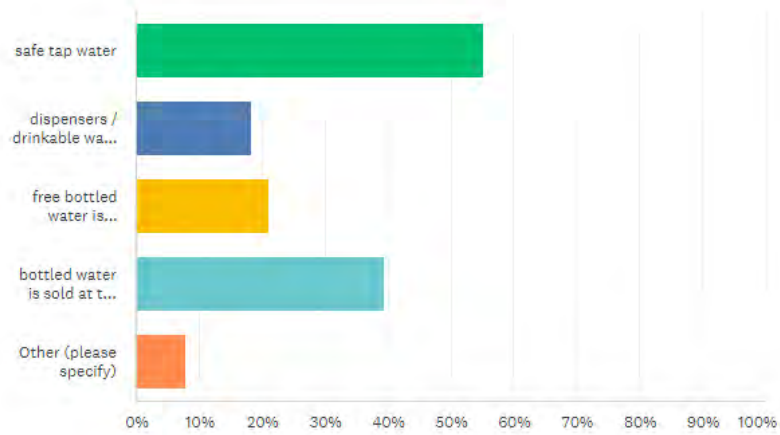

CHOIX DE RÉPONSES	RÉPONSES	
▼ safe tap water	55,26 %	21
▼ dispensers / drinkable water to refill reusable bottles for free	18,42 %	7
▼ free bottled water is distributed	21,05 %	8
▼ bottled water is sold at the event	39,47 %	15
▼ Other (please specify)	Réponses 7,89 %	3
Nombre total de participants : 38		



CHOIX DE RÉPONSES	RÉPONSES
▼ Carry one or more shopping bags with you and reuse them, so you don't have to ask the shop for them. Ideally, canvas bags.	92,59 % 25
▼ Buy second-hand whenever possible, from clothes to household appliances. It has an impact on packaging.	29,63 % 8
▼ For ladies, use menstrual cups or washable pads.	11,11 % 3
▼ Buy food in bulk as much as possible. Some places allow you to bring your own container.	33,33 % 9
▼ Use washable cotton pads to remove make-up.	25,93 % 7
▼ Use compostable dental floss and cotton bud with a wooden or bamboo stick.	25,93 % 7
▼ Pass to a safety razor rather than a disposable one. The problem with disposable razors is that the head is made of so many different materials that it is impossible to recycle it. In revenge, the stainless steel blades are much cheaper and fully recyclable.	40,74 % 11
▼ If you have a capsule coffee machine, switch to reusable stainless steel capsules.	22,22 % 6
▼ If you drink filtered coffee, switch to compostable filters.	18,52 % 5
▼ Don't throw away food leftovers but reuse them in a creative way (e.g. dry bread salad, vegetable peels to make broth,...).	44,44 % 12
▼ Get into the habit of asking a doggy bag for the dishes you cannot finish at the restaurant.	48,15 % 13
▼ Anything you no longer use, do not throw it away, try to donate or sell it.	70,37 % 19
▼ Carry along a small towel to dry your hands.	33,33 % 9
<b>Nombre total de participants : 27</b>	

CHOIX DE RÉPONSES	RÉPONSES
▼ Collect abandoned plastic at every opportunity, regardless if you are on the beach or in the mountains.	70,37 % 19
▼ Rediscover solid soap instead of liquid soap and bubble bath, you will avoid the plastic bottle. Same for shampoo and conditioner, they exist solid as well.	44,44 % 12
▼ Switch to wooden or bamboo comb rather than plastic one.	25,93 % 7
▼ Deodorant and tooth paste: prefer those which come in glass or tin, rather than in a plastic container.	33,33 % 9
▼ Remember to say: "No straw, please", each time you order a drink.	70,37 % 19
▼ Equip yourself with a reusable bottle	66,67 % 18
▼ Prefer natural fibre clothes to synthetic ones, the latter release microplastic at every wash.	48,15 % 13
▼ When travelling, carry along the kit of the perfect plastic free traveller: cutlery or a spork, reusable straw, camping plate.	33,33 % 9
▼ Keep a reusable cup in your bag, to avoid the carnage of plastic cups.	37,04 % 10
▼ Switch to beeswax cloths rather than plastic film for food storage.	33,33 % 9
<b>Nombre total de participants : 27</b>	

CHOIX DE RÉPONSES	RÉPONSES	
▼ Turn off the water tap while brushing your teeth.	85,19 %	23
▼ Install water reducer at every tap and shower you have home.	29,63 %	8
▼ After rinsing the salad, recycle the water (e.g. to water your plants, to flush the WC,...).	33,33 %	9
▼ Pull the plug of all the appliances when you do not use them.	51,85 %	14
▼ Switch off the light, when you are not in the room.	77,78 %	21
▼ Move to energy from renewable sources as much as possible.	48,15 %	13
▼ If you are not charging your cell phone, disconnect it from the plug.	74,07 %	20
▼ Prefer L.E.D. bulbs.	81,48 %	22
▼ Bundle up before turning up the heating in cold weather.	55,56 %	15
<b>Nombre total de participants : 27</b>		

CHOIX DE RÉPONSES	RÉPONSES	
▼ Zinc-based solar screen does not harm marine life and it is coral-friendly.	38,46 %	10
▼ If you really cannot do it without disposable, opt for biodegradable products.	61,54 %	16
▼ Be thorough in your garbage separation.	76,92 %	20
▼ Prefer bicycle, car-sharing and public transport to the private car, whenever possible.	42,31 %	11
▼ Prefer local food to oversea imported food.	80,77 %	21
▼ When throwing away your mask, cut the elastics.	50,00 %	13
▼ When throwing away your food packaging, break them up as much as possible to prevent animals from getting stuck in them.	65,38 %	17
▼ Switch to steam cleaner to reduce chemicals when cleaning your house.	19,23 %	5
<b>Nombre total de participants : 26</b>		

---

## 2023 STATUS REPORT

### OLYMPIC GAMES QUALIFICATION SYSTEM WORKING GROUP

---

During last year the group had submitted a proposition to the FIE Executive Committee of having a system with two-members teams plus the alternate, bearing in mind that it constituted an absolute reform of the team format and competitions.

The Executive Committee considered that the idea proposed by the working group (two fencers per team instead of three) transforms the team concept into a “double” concept, like in tennis. This would imply a total revolution of the team format and team competitions and that the possible future consequences could be counterproductive.

The Executive Committee therefore concluded that the existing qualification system was currently the only viable one, taking into account the existing rules and limitations.

In addition, the transfer of accreditations has been examined as a possible alternative. This would mean that an accreditation is withdrawn/cancelled just after the athlete has finished his or her competition, and his or her accreditation is provided to another athlete. The transfer of accreditations was discussed in the past with the IOC and was not accepted for the main following reasons: a) As per the Olympic Charter, accreditations are withdrawn for specific reasons (such as sanctions). Otherwise, they are valid for the period of the Games. b) each NOC has a fixed quota of accreditations for the whole period of the Games. c) Fencers don't arrive on the date of their competitions but a few days earlier to train. And because of this flow there would always be more than 212 athletes. d) The organisers would have a lot of trouble managing all the athletes and officials entering and leaving the Olympic Village and the accreditation system.

The FIE had discussed the issue of transferable accreditations with the IOC in the past. The IOC did not accept this request for the above reasons adding that an athlete has the right to stay for the whole period of the OG should he/she would like to.

The main difference between Tokyo 2020 and Paris 2024 qualification systems is that for Paris there will be 6 additional host country quota places, instead of 8 that existed for Tokyo, leaving two (2) universality places (one per gender) available to eligible NOCs and allocated by the IOC. The NOCs will submit their requests

until January 2024, they will then be evaluated by the IOC. Following that the IOC will propose to the IFs the universality places.

Based on these facts, the working group was asked to continue its efforts and to put forward new alternative proposals that would allow to increase places for individual qualification.

The Olympic Games Qualification System Working Group resumed its works on a meeting on Monday, 4 September 2023 at 23.00 CET.

The following members attended the meeting:

Mr. Emmanuel KATSIADAKIS (MH), FIE Interim President, Chair of the Working group  
Mr. Vukašin STOŠIĆ, Secretary General of the Serbian Fencing Federation  
Mr. Francisco Rafael MARÍN ALVAREZ, President of the Fencing Federation of Venezuela  
Mrs. Nathalie RODRIGUEZ, FIE CEO

Absent:

Mr. Sam CHERIS (MH), President of the FIE Legal Commission  
Mr. Salah FERJANI, Member of the FIE Refereeing Commission  
Mr. Vincent ELIAS, President of the Australian Fencing Federation  
Mr. Jong Hyung CHO, Vice President of the Korean Fencing Federation

Following that meeting the chair of the group addressed letter to all the working group members asking them to submit in writing their proposals or ideas until Friday, September 15<sup>th</sup>.

On expiry of the deadline set for the 15<sup>th</sup> of September no proposal had been submitted.

Although no progress was made, however it is important that an Olympic Qualification System Working Group should continue to exist and determine whether there are areas for potential improvement and to develop proposal(s) which comply with all the principles of the Olympic Charter and IOC Guidelines for consideration by the Executive Committee of the FIE on such a complex and serious issue.

Based on the above facts, the Chair of the working group proposes that the group continues with a new composition.

A handwritten signature in blue ink, appearing to read 'E. Katsiadakis', with a stylized flourish at the end.

Emmanuel Katsiadakis  
FIE interim President and Chair of the working group

ФЕДЕРАЦІЯ ФЕХТУВАННЯ УКРАЇНИ

Київ 03022 Васильківська, 24,  
к 8А  
тел/факс: 380 44 2894088  
<http://www.nffu.org.ua>



PUBLIC ORGANIZATION  
UKRAINIAN FENCING FEDERATION

24 Vasylkivska - Kiev 03022  
tel/fax: 380 44 2894088  
e-mail: [nffu@nffu.org.ua](mailto:nffu@nffu.org.ua)  
[ukr-fencing@ukr.net](mailto:ukr-fencing@ukr.net)

# 24/03/23-4 dated 24.03.2023

To: Interim President of the FIE  
Mr. Emmanuel KATSIADAKIS  
International Fencing Federation  
MAISON DU SPORT INTERNATIONAL  
AV. DE RHODANIE 54  
1007 LAUSANNE SWITZERLAND  
Telephone  
+41 21 320 3115  
Fax  
+41 21 320 3116  
Email  
[info@fie.ch](mailto:info@fie.ch)

copy:  
CEO of the FIE  
Mrs. Nathalie Rodriguez  
Email  
[nr@fie.ch](mailto:nr@fie.ch)

Ukrainian Fencing Federation submits propositions for ordinary Congress of the International Fencing Federation (FIE), designated on 25 of November, 2023 in Sharm-El-Sheikh (EGY):

To suspend membership in the FIE of the Russian Fencing Federation (RUS) and the Belarus Fencing Federation (BLR) in connection with the rough violation of the ethical principles of dignity, integrity, and relationships with countries, the rules of conduct, and the general principles of sports justice by the Russian Fencing Federation (RUS) and the Belarus Fencing Federation (BLR).

Not allow athletes, coaches, officials, holding Russian or Belarus citizenships and licenses, registered by the Russian Fencing Federation (RUS) and/or the Belarus Fencing Federation (BLR) to participate in competitions of the FIE.

Kindest regards

**The First Vice-President  
of Ukrainian Fencing Federation**

**Sergii MISHCHENKO**

